

MRC double-row angular contact ball bearings are manufactured in two main types: C-type (Conrad construction) and M-type (maximum capacity with filling notches). Each of the two rows has a 30° contact angle.

C-type

Conrad construction, or C-type, double-row ball bearings have contact angles that converge outside the bearing, thereby increasing resistance to misalignment. This type does not have filling notches. These bearings are recommended for applications where single-row ball bearings are inadequate, but radial loads are not so great as to suggest a filling-notch bearing. They will take heavy radial loads and axial loads equally in either direction. The C-type design fully meets the requirements of American Petroleum Institute (API) Specification 610.

Both the inner and the outer rings have closure grooves. These bearings are available with seals, shields, and snap-rings.

M-type

Maximum capacity double-row ball bearings have filling notches on one side to permit assembling the maximum number of balls into the bearing. Contact angles converge outside the bearing. All inner and outer rings have closure grooves. These bearings may be equipped with seals, shields, and snap-rings. The M-type bearing has very heavy radial capacity. It also has thrust capacity in one direction, with the ability to accommodate light thrust load in the reversing direction.

Part numbers on M-type double-row bearings are normally located on either the side face or the O.D. surface of the bearing. The side face marking is always on the side opposite the filling notch and the O.D. marking is offset from the center away from the filling notch. Therefore, double sealed or shielded bearings with the filling notch covered from view can be oriented correctly.

Ball Cages and Types

The cage supplied with C-type and M-type bearings is a one-piece crown-type of heat-treated pressed steel. It is snapped into place after the full quota of balls has been introduced between the inner and outer ring.

Size	Series	Page
5200C	Light, Conrad (Non-Filling Notch)	93
5200C1	Light, Extra Width, Conrad (Non-Filling Notch)	93
5300C	Medium, Conrad (Non-Filling Notch)	94
5300C1	Medium, Extra Width, Conrad (Non-Filling Notch)	94
5400C	Heavy, Conrad (Non-Filling Notch)	95
5200M	Light, Filling Notch	96
5200M1	Light, Extra Width, Filling Notch	96
5300M	Medium, Filling Notch	97
5300M1	Medium, Extra Width, Filling Notch	97
5300UPG	MRC Pump Bearing	98
Width Summary and Interchange from Old Series to C & M Series		85
Filling Notch Location on Closed Bearings		88
Axial and Radial Internal Clearance		89
Thrust Rating		90
Extra Wide Retrofit Kit and Mounting Instructions		91
Equivalent Load and Life		99
Minimum Radial Load Calculation		99
Life Calculation Examples		100

The older MRC 5000 series double-row ball bearings were made in three series — 5200 Light, 5300 Medium, and 5400 Heavy — each with progressively larger cross sections. These old-style 5000 type double-rows were available in the SB Conrad and maximum capacity configurations. The SB Conrad version had contact angles which diverged inwardly, thereby increasing resistance to misalignment. The maximum capacity version had contact angles which converged inwardly, giving it the capability of handling small amounts of misalignment. It also had filling notches on both sides, for the introduction of a maximum complement of balls.

Our double-row ball bearings are available in the C-type (Conrad construction) and M-type (with filling notches on one side only). Both types feature inwardly diverging contact angles, which provide

greater rigidity than found in the previous double-row filling-notch type bearings. A unique manufacturing system utilizing “common parts” is employed in the manufacture of these bearings. Using a minimum number of components, the system provides greater flexibility for producing either Conrad or maximum capacity types as open bearings or with a variety of closures. Twenty-four variations of a single bearing size can be manufactured to solve your application problems.

The chart on pages 85-86 outlines the suffixes and widths of MRC 5000 series bearings. The data on the chart do not represent actual availability of double-row products. These data are intended to be used as references for interchanging. Current style double-rows appear next to their old-style counterparts that are the same width.

MRC Double-Row Suffix Identification Summary

Suffix	Description	Suffix	Description
B	Rigid construction, maximum capacity.	M1	1/8" additional width from standard.
BK	Rigid construction, maximum capacity, standard width.		5205M1 & 5212M1 are 1/16" wider than standard.
C	Conrad, rigid construction, standard width.	Plain	Maximum capacity, nonrigid construction. Narrow width in 5200 series, extra width is required with closures.
C1	1/8" additional width from standard. 5205C1 & 5212C1 are 1/16" wider than standard.	S	Conrad construction (Note: always combined with additional suffix letters)
F	One shield	SB	Conrad, rigid construction, narrow width. Extra width is required with closures.
FF	Two shields	SBK	Conrad, rigid construction, standard width.
G	Snap-ring	Z	One seal
K	Standard width	ZZ	Two seals
M	Maximum capacity, rigid construction, standard width.		

Basic Bearing Number	Old— Style Suffix	New— Style Suffix	Width (inches)	Basic Bearing Number	Old— Style Suffix	New— Style Suffix	Width (inches)	Basic Bearing Number	Old— Style Suffix	New— Style Suffix	Width (inches)
5200 Series				5206	F	MF1	1 ¹ / ₁₆		—	C	1 ³ / ₁₆
5106	SBZZ		29 ²⁹ / ₃₂		K	M	1 ⁵ / ₁₆				
5200	SB		9 ⁹ / ₁₆		KF	MF	1 ⁵ / ₁₆				
	SBKF		9 ⁹ / ₁₆		KFF	MFF	1 ⁵ / ₁₆				
	SBKFF		9 ⁹ / ₁₆		KG	MG	1 ⁵ / ₁₆				
	SBKZ		9 ⁹ / ₁₆		Plain		3 ³ / ₄				
	SBKZZ		9 ⁹ / ₁₆		SBF	CF1	1 ¹ / ₁₆				
5201	SB		5 ⁵ / ₈		SBK	C	1 ⁵ / ₁₆				
	SBFG		5 ⁵ / ₈		SBKF	CF	1 ⁵ / ₁₆				
	SBKF		5 ⁵ / ₈		SBKFF	CFF	1 ⁵ / ₁₆				
	SBKFF		5 ⁵ / ₈		SBKFFG	CFFG	1 ⁵ / ₁₆				
	SBKFFG		5 ⁵ / ₈		SBKFG	CFG	1 ⁵ / ₁₆				
	SBKFG		5 ⁵ / ₈		SBKG	CG	1 ⁵ / ₁₆				
	SBKZ		5 ⁵ / ₈		SBZZ	CZZ1	1 ¹ / ₁₆				
	SBKZZ		5 ⁵ / ₈		SBKZZG	CZZG1	1 ¹ / ₁₆				
5202	Plain		5 ⁵ / ₈	5207	—	C1, M1	1 ¹ / ₁₆				
	SB		5 ⁵ / ₈		F	MF1	1 ³ / ₁₆				
	SBFG		1 ¹ / ₁₆		K	M	1 ¹ / ₁₆				
	SBKF		5 ⁵ / ₈		KF	MF	1 ¹ / ₁₆				
	SBKFF		5 ⁵ / ₈		KFF	MFF	1 ¹ / ₁₆				
	SBKFG		5 ⁵ / ₈		KFG	MFG	1 ¹ / ₁₆				
	SBKZZ		5 ⁵ / ₈		KG	MG	1 ¹ / ₁₆				
5203	SB		1 ¹ / ₁₆		Plain		7 ⁷ / ₈				
	SBKF		1 ¹ / ₁₆		SBK	C	1 ¹ / ₁₆				
	SBKFF		1 ¹ / ₁₆		SBKF	CF	1 ¹ / ₁₆				
	SBKFFG		1 ¹ / ₁₆		SBKFF	CFF	1 ¹ / ₁₆				
	SBKFG		1 ¹ / ₁₆		SBKFG	CFG	1 ¹ / ₁₆				
	SBKZ		1 ¹ / ₁₆		SBKFG	CFG	1 ¹ / ₁₆				
	SBKZZ		1 ¹ / ₁₆		SBKGG	CG	1 ¹ / ₁₆				
5204	Plain		3 ³ / ₄	5208	—	C1, M1	1 ³ / ₁₆				
	K	M	1 ³ / ₁₆		BKF	MF	1 ³ / ₁₆				
	KF	MF	1 ³ / ₁₆		BKFF	MFF	1 ³ / ₁₆				
	SB		3 ³ / ₄		K	M	1 ³ / ₁₆				
	SBK	C	1 ³ / ₁₆		KF	MF	1 ³ / ₁₆				
	SBKF	CF	1 ³ / ₁₆		KFF	MFF	1 ³ / ₁₆				
	SBKFF	CFF	1 ³ / ₁₆		KFG	MFG	1 ³ / ₁₆				
	SBKFFG	CFFG	1 ³ / ₁₆		KG	MG	1 ³ / ₁₆				
	SBKFG	CFG	1 ³ / ₁₆		Plain		1				
	SBKG	CG	1 ³ / ₁₆		SBK	C	1 ³ / ₁₆				
	SBKZ	CZ	1 ³ / ₁₆		SBKF	CF	1 ³ / ₁₆				
5205	F	MF1	7 ⁷ / ₈		SBKFF	CFF	1 ³ / ₁₆				
	K	M	1 ³ / ₁₆		SBKFG	CFG	1 ³ / ₁₆				
	KG	MG	1 ³ / ₁₆		SBKG	CG	1 ³ / ₁₆				
	Plain		3 ³ / ₄	5209	K	M	1 ³ / ₁₆				
	SB		3 ³ / ₄		KF	MF	1 ³ / ₁₆				
	SBF	CF1	7 ⁷ / ₈		KG	MG	1 ³ / ₁₆				
	SBK	C	1 ³ / ₁₆		Plain		1				
	SBKF	CF	1 ³ / ₁₆		SBK	C	1 ³ / ₁₆				
	SBKFF	CFF	1 ³ / ₁₆		SBKF	CF	1 ³ / ₁₆				
	SBKFFG	CFFG	1 ³ / ₁₆		SBKFF	CFF	1 ³ / ₁₆				
	SBKFG	CFG	1 ³ / ₁₆		SBKFG	CFG	1 ³ / ₁₆				
	SBKG	CG	1 ³ / ₁₆		SBKG	CG	1 ³ / ₁₆				
	—	C1, M1	7 ⁷ / ₈	5210	K	M	1 ³ / ₁₆				
					KF	MF	1 ³ / ₁₆				
					KFF	MFF	1 ³ / ₁₆				
					KG	MG	1 ³ / ₁₆				
					Plain		1				

5000 Series Bearings Suffix and Width Summary

MRC Bearing Services

Basic Bearing Number	Old— Style Suffix	New— Style Suffix	Width (inches)	Basic Bearing Number	Old— Style Suffix	New— Style Suffix	Width (inches)	Basic Bearing Number	Old— Style Suffix	New— Style Suffix	Width (inches)
5300 Series				5307	BKFF	MFF	1 ³ / ₈	5315	F	MF1	2 ¹³ / ₁₆
5300	SB		3 ⁴ / ₄		F	MF1	1 ¹ / ₂		G	MG	2 ¹¹ / ₁₆
5301	SB		3 ⁴ / ₄		FG	MFG1	1 ¹ / ₂		Plain	M	2 ¹¹ / ₁₆
5302	Plain		3 ⁴ / ₄		G	MG	1 ³ / ₈		—	C	2 ¹¹ / ₁₆
	SB		3 ⁴ / ₄		KF	MF	1 ³ / ₈		—	C1, M1	2 ¹³ / ₁₆
5303	G		7 ⁸ / ₈		KFG	MFG	1 ³ / ₈	5316	G	MG	2 ¹¹ / ₁₆
	KF		7 ⁸ / ₈		Plain	M	1 ³ / ₈		Plain	M	2 ¹¹ / ₁₆
	KFG		7 ⁸ / ₈		—	C1, M1	1 ¹ / ₂		—	C	2 ¹¹ / ₁₆
	SB		7 ⁸ / ₈		—	C	1 ³ / ₈	5317	Plain		2 ⁷ / ₈
	SBG		7 ⁸ / ₈	5308	BG	MG	1 ⁷ / ₁₆		—	C	2 ⁷ / ₈
	SBKF		7 ⁸ / ₈		F	MF1	1 ⁹ / ₁₆	5318	Plain		2 ⁷ / ₈
	SBKFF		7 ⁸ / ₈		FG	MFG1	1 ⁹ / ₁₆		—	C	2 ⁷ / ₈
	SBKFFG		7 ⁸ / ₈		G	MG	1 ⁷ / ₁₆	5319	Plain		3 ¹ / ₁₆
5304	F	MF1	1		Plain	M	1 ⁷ / ₁₆		—	C	3 ¹ / ₁₆
	Plain	M	7 ⁸ / ₈		—	C	1 ⁷ / ₁₆	5320	Plain		3 ¹ / ₁₆
	SB	C	7 ⁸ / ₈		—	C1, M1	1 ⁹ / ₁₆	5321	Plain		3 ⁷ / ₁₆
	SBF	CF1	1	5309	B	M	1 ⁹ / ₁₆		5322	Plain	3 ⁵ / ₈
	SBG	CG	7 ⁸ / ₈		F	MF1	1 ¹¹ / ₁₆	5400 Series			
	SBKF	CF	7 ⁸ / ₈		FG	MFG1	1 ¹¹ / ₁₆	5403	Plain		1 ³ / ₁₆
	SBKFF	CFF	7 ⁸ / ₈		G	MG	1 ⁹ / ₁₆	5404	Plain		1 ³ / ₈
	SBKFFG	CFFG	7 ⁸ / ₈		Plain	M	1 ⁹ / ₁₆	5405	Plain		1 ³ / ₈
	SBKFG	CFG	7 ⁸ / ₈		—	C	1 ⁹ / ₁₆	5406	Plain		1 ⁹ / ₁₆
	—	C1, M1	1		—	C1, M1	1 ¹¹ / ₁₆		—	C	1 ⁹ / ₁₆
5305	F		1 ¹ / ₈	5310	F	MF1	1 ⁷ / ₈	5407	G		1 ³ / ₄
	FG		1 ¹ / ₈		FG	MFG1	1 ⁷ / ₈		Plain		1 ³ / ₄
	G	MG	1		G	MG	1 ³ / ₄		—	C	1 ³ / ₄
	KFF	MFF	1		KF	MF	1 ³ / ₄	5408	Plain		1 ³ / ₄
	Plain	M	1		KFG	MFG	1 ³ / ₄		—	C	1 ³ / ₄
	SB	C	1		Plain	M	1 ³ / ₄		Plain		1 ¹⁵ / ₁₆
	SBF		1 ¹ / ₈		—	C	1 ³ / ₄		—	C	1 ¹⁵ / ₁₆
	SBFG		1 ¹ / ₈		—	C1, M1	1 ⁷ / ₈	5409	G		2 ¹ / ₈
	SBG	CG	1	5311	F	MF1	2 ¹ / ₁₆		Plain		2 ¹ / ₈
	SBKF	CF	1		FG	MFG1	2 ¹ / ₁₆		—	C	2 ¹ / ₈
	SBKFF	CFF	1		G	MG	1 ¹⁵ / ₁₆	5410	F		2 ⁷ / ₁₆
	SBKFFG	CFG	1		Plain	M	1 ¹⁵ / ₁₆		Plain		2 ⁹ / ₁₆
5306	B	M	1 ³ / ₁₆		—	C	1 ¹⁵ / ₁₆		—	C	2 ⁹ / ₁₆
	BKFF	MFF	1 ³ / ₁₆		—	C1, M1	2 ¹ / ₁₆	5411	F		2 ⁵ / ₈
	F	MF1	1 ³ / ₁₆	5312	F	MF1	2 ¹ / ₄		G		2 ¹ / ₂
	FG	MFG1	1 ⁵ / ₁₆		FG	MFG1	2 ¹ / ₄		Plain		2 ¹ / ₂
	G	MG	1 ³ / ₁₆		G	MG	2 ¹ / ₈		—	C	2 ¹ / ₂
	KF	MF	1 ³ / ₁₆		Plain	M	2 ¹ / ₈	5412	Plain		2 ⁵ / ₈
	KFF	MFF	1 ³ / ₁₆		—	C	2 ¹ / ₈		—	C	2 ⁵ / ₈
	KFG	MFG	1 ³ / ₁₆		—	C1, M1	2 ¹ / ₄	5413	Plain		2 ¹³ / ₁₆
	Plain	M	1 ³ / ₁₆	5313	F	MF1	2 ⁷ / ₁₆		—	C	2 ¹³ / ₁₆
	—	C1, M1	1 ³ / ₁₆		FG	MFG1	2 ⁷ / ₁₆	5414	Plain		3 ¹ / ₈
	—	C	1 ³ / ₁₆		G	MG	2 ⁹ / ₁₆		—	C	3 ¹ / ₈
					Plain	M	2 ⁹ / ₁₆	5415	Plain		3 ¹ / ₄
					—	C	2 ⁹ / ₁₆		—	C	3 ¹ / ₄
					—	C1, M1	2 ⁷ / ₁₆	5416	Plain		3 ⁷ / ₁₆
				5314	F	MF1	2 ⁵ / ₈		—	C	3 ⁷ / ₁₆
					G	MG	2 ¹ / ₂	5417	Plain		3 ⁵ / ₈
					KF	MF	2 ¹ / ₂		—	C	3 ⁵ / ₈
					KFG	MFG	2 ¹ / ₂	5418	Plain		3 ⁷ / ₈
					Plain	M	2 ¹ / ₂		—	C	3 ⁷ / ₈
					—	C	2 ¹ / ₂	5419	Plain		4 ³ / ₁₆
					—	C1, M1	2 ⁵ / ₈				

Bearing numbers of MRC double-row ball bearings produced before 1983 differ from the C- and M-types listed in this catalog. Shown below is the interchange of pre-1983 bearing numbers with the C- and M-types.

5000 Series double-row bearings not listed here maintain the original bearing number and must be specified by that number when ordering.

MRC Bearing Numbers		MRC Bearing Numbers		MRC Bearing Numbers	
Prior to 1983	Superseded by	Prior to 1983	Superseded by	Prior to 1983	Superseded by
5200SB	5200C*	5211K	5211M	5306	5306M
5200SBKF	5200CF*	5211KF	5211MF	5306F	5306MF1
5200SBKFF	5200CFF*	5211KFG	5211MFG	5306FG	5306MFG1
5200SBKZ	5200CZ*	5211KG	5211MG	5306G	5306MG
5200SBKZZ	5200CZZ*	5212F	5212MF1	5306KF	5306MF
5201SB	5201C*	5212FG	5212MFG1	5306KFF	5306MFF
5201SBKF	5201CF*	5212K	5212M	5306KFG	5306MFG
5201SBKFF	5201CFF*	5212KF	5212MF	5307	5307M
5201SBKZ	5201CZ*	5212KFG	5212MFG	5307F	5307MF1
5201SBKZZ	5201CZZ*	5212KG	5212MG	5307FG	5307MFG1
5202SB	5202C*	5213K	5213M	5307G	5307MG
5202SBKFF	5202CF*	5213KF	5213MF	5307KF	5307MF
5202SBFG	5202CFG1*	5213KFG	5213MFG	5307KFG	5307MFG
5202SBKFG	5202CFG*	5213KG	5213MG	5308	5308M
5202SBKZ	5202CZ*	5214K	5214M	5308F	5308MF1
5202SBKZZ	5202CZZ*	5214KF	5214MF	5308FG	5308MFG1
5203SB	5203C*	5214KG	5214MG	5308G	5308MG
5203SBKF	5203CF*	5215K	5215M	5309	5309M
5203SBKFF	5203CFF*	5215KF	5215MF	5309B	5309M
5203SBKFG	5203CFG*	5215KFF	5215MFF	5309F	5309MF1
5203SBKZ	5203CZ*	5215KFG	5215MFG	5309FG	5309MFG1
5203SBKZZ	5203CZZ*	5215KG	5215MG	5309G	5309MG
5204SBK	5204C	5216K	5216M	5310	5310M
5204SBKF	5204CF	5216KF	5216MF	5310F	5310MF1
5204SBKFF	5204CFF	5216KFG	5216MFG	5310FG	5310MFG1
5204SBKFG	5204CFG	5216KG	5216MG	5310G	5310MG
5204SBKFFG	5204CFFG	5217K	5217M	5310KF	5310MF
5204SBKG	5204CG	5217KF	5217MF	5310KFG	5310MFG
5204SBKZ	5204CZ	5217KG	5217MG	5311	5311M
5205SBK	5205C	5218K	5218M	5311F	5311MF1
5205SBF	5205CF1	5218KF	5218MF	5311FG	5311MFG1
5205SBKF	5205CF	5218KFG	5218MG	5311G	5311MG
5205SBKFF	5205CFF	5219	5219G	5312	5312M
5205SBKG	5205CG	5219G	5219G	5312F	5312MF1
5206SBK	5206C	5220	5220G	5312FG	5312MFG1
5206SBF	5206CF1	5220G	5220G	5312G	5312MG
5206SBKF	5206CF	5221	5221G	5313	5313M
5206SBKFF	5206CFF	5221	5221G	5313F	5313MF1
5206SBKFG	5206CFG	5222	5222G	5313FG	5313MFG1
5206SBKG	5206CG	5222KF	5222KF	5313G	5313MG
5206SBZZ	5206CZZ1	5300SB	5300C*	5314	5314M
5207F	5207MF1	5301SB	5301C*	5314F	5314MF1
5207SBK	5207C	5302SB	5302C*	5314G	5314MG
5207SBKF	5207CF	5303SB	5303C*	5314KF	5314MF
5207SBKFF	5207CFF	5303SBG	5303CG*	5315	5315M
5207SBKFG	5207CFG	5303SBKF	5303CF*	5315F	5315MF1
5207SBKG	5207CG	5303SBKFF	5303CFF*	5315G	5315MG
5208SBK	5208C	5303SBKFG	5303CFG*	5316	5316M
5208SBKF	5208CF	5304SB	5304C	5316G	5316MG
5208SBKFF	5208CF	5304SBF	5304CF1	5317	5317
5208SBKFFG	5208CFF	5304SBKF	5304CF	5318	5318
5208SBKFG	5208CFG	5304SBKFF	5304CFF	5319	5319
5208SBKG	5208CG	5305SB	5305C	5320	5320
5209K	5209M	5305SBG	5305CG	5321	5321
5209KF	5209MF	5305SBKF	5305CF	5322	5322
5209SBFF	5209CFF	5305SBKFF	5305CFF		
5209KG	5209MG	5305SBKFG	5305CFG		
5210K	5210M				
5210KF	5210MF				
5210KFF	5210MFF				
5210KG	5210MG				

*Listed for information only. Not currently in production. Use SB types.

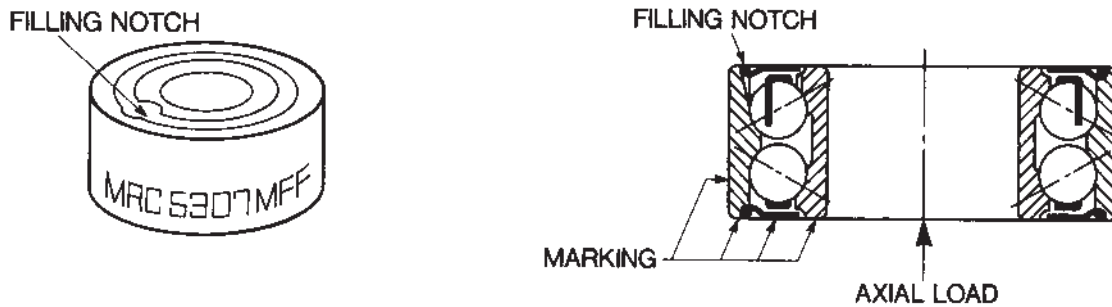

Since the filling notch row is not visible on 5000MFF and 5000MZZ bearings, it is necessary to identify which row of balls has the notch in those cases where the bearing will be subjected to axial load. Axial load should be carried on the non-filling notch row. A moderate reversing axial load is permissible on the filling notch row.

A typical application of a 5000MFF or 5000MZZ bearing is shown above in which it is subjected to an axial load in an upward direction. The bearing should be mounted with the filling notch up so that the axial load is taken by the bottom, non-filling notch row.

The filling notch is oriented in relation to the identification marking on the bearing, which will be found in one of the following locations:

- Side face of the outer ring
- Side face of the inner ring
- OD surface of the outer ring
- Face of the closure

In each case the marking will occur on the side of the bearing opposite the filling notch as illustrated above.

5200 and 5300 Series

Bore Diameter d				Axial Internal Clearance															
Over		Including		C2				Normal C0				C3				C4			
mm	in	mm	in	.001 mm		.0001 in		.001 mm		.0001 in		.001 mm		.0001 in		.001 mm		.0001 in	
				Min	Max	Min	Max	Min	Max	Min	Max	Min	Max	Min	Max	Min	Max	Min	Max
10	.3937	10	.3937	1	11	0	4	5	21	2	8	12	28	5	11	25	45	10	18
18	.7087	18	.7087	1	12	0	5	6	23	2	9	13	31	5	12	27	47	11	19
		24	.9449	2	14	1	6	7	25	3	10	16	34	6	13	28	48	11	19
24	.9449	30	1.1811	2	15	1	6	8	27	3	11	18	37	7	15	30	50	12	20
30	1.1811	40	1.5748	2	16	1	6	9	29	4	11	21	40	8	16	33	54	13	21
40	1.5748	50	1.9685	2	18	1	7	11	33	4	13	23	44	9	17	36	58	14	23
50	1.9685	65	2.5591	3	22	1	9	13	36	5	14	26	48	10	19	40	63	16	25
65	2.5591	80	3.1496	3	24	1	9	15	40	6	16	30	54	12	21	46	71	18	28
80	3.1496	100	3.9370	3	26	1	10	18	46	7	18	35	63	14	25	55	83	22	33
100	3.9370	110	4.3307	4	30	2	12	22	53	9	21	42	73	17	29	65	96	26	38

Bore Diameter d				Radial Internal Clearance															
Over		Including		C2				Normal C0				C3				C4			
mm	in	mm	in	.001 mm		.0001 in		.001 mm		.0001 in		.001 mm		.0001 in		.001 mm		.0001 in	
				Min	Max	Min	Max	Min	Max	Min	Max	Min	Max	Min	Max	Min	Max	Min	Max
10	.3937	10	.3937	0.6	7	0	2.4	3	13	1.2	5	8	18	3	7	15	27	6	11
18	.7087	18	.7087	0.6	7	0	3	3.6	14	1.2	5	8	18	3	7	18	27	7	11
		24	.9449	1.2	8	0.6	3.6	4	15	1.8	6	11	21	4	8	18	27	7	11
24	.9449	30	1.1811	1.2	9	0.6	3.6	5	16	1.8	7	11	23	4	9	18	31	7	12
30	1.1811	40	1.5748	1.2	10	0.6	3.6	5	17	2.4	7	12	25	5	10	21	33	8	13
40	1.5748	50	1.9685	1.2	11	0.6	4	7	20	2.4	8	12	25	5	10	21	36	8	14
50	1.9685	65	2.5591	1.8	13	0.6	5	8	22	3	8	15	27	6	11	25	38	10	15
65	2.5591	80	3.1496	1.8	14	0.6	5	9	24	3.6	10	18	33	7	13	27	44	11	17
80	3.1496	100	3.9370	1.8	16	0.6	6	11	28	4	11	21	38	8	15	33	50	13	20
100	3.9370	110	4.3307	2.4	18	1.2	7	13	32	5	13	25	44	10	17	40	58	16	23

5400 Series

Bore Diameter d				Radial Internal Clearance															
Over		Including		C2				Normal C0				C3				C4			
mm	in	mm	in	.001 mm		.0001 in		.001 mm		.0001 in		.001 mm		.0001 in		.001 mm		.0001 in	
				Min	Max	Min	Max	Min	Max	Min	Max	Min	Max	Min	Max	Min	Max	Min	Max
30	1.1811	30	1.1811	1	8	0.4	3	2	13	1	5	13	23	5	9	20	38	8	15
40	1.5748	40	1.5748	1	8	0.5	3	6	13	2	5	15	23	6	9	23	41	9	16
		50	1.9685	1	8	0.5	3	6	15	2	6	15	25	6	10	23	44	9	17
50	1.9685	65	2.5591	1	11	0.5	4	6	15	2	6	15	28	6	11	25	45	10	18
65	2.5591	70	2.7559	1	11	0.5	4	6	18	2	7	18	31	7	12	28	48	11	19
70	2.7559	80	3.1496	0	6	0	2	6	18	2	7	18	33	7	13	33	48	13	19
80	3.1496	90	3.5433	0	7	0	3	7	23	3	9	23	44	9	17	44	65	17	26

**Thrust Rating of 5000 Series
Double-Row Angular Contact Ball Bearings**

MRC Bearing Services

Dynamic Rating

To obtain dynamic thrust rating multiply dynamic radial rating C by the factor shown below.

Size	Factor
5200SB-5203SB 5300SB-5303SB 5403C-5414C	0.71
5204C&M-5218C&M 5304C&M-5319C&M	0.81

Example:

Bearing size: 5307C
Basic dynamic radial load rating (C) = 11100 lbf
Thrust rating factor = 0.81
Thrust rating = $0.81 \times 11100 = 8991$ lbf

Sizes 5415C-5419C have 0° contact angles and are not included in the above tables. When thrust load is present, the equivalent radial load should be used to determine life.

Static Rating

To obtain static thrust rating multiply static radial rating C₀ by the factor shown below.

Size	Factor
5200SB-5203SB 5300SB-5303SB 5204C&M-5206C&M 5403C-5414C	0.57
5207C&M-5218C&M 5304C&M-5319C&M	0.66

Example:

Bearing size: 5214M
Basic static radial load rating (C₀) = 28100 lbf
Thrust rating factor = 0.66
Thrust rating = $0.66 \times 28100 = 18546$ lbf

Double-row angular contact ball bearings with non-standard extra wide width are currently available as a retrofit kit. These replacement units consist of a standard width double-row angular contact ball bearing and two specially designed spacers packaged together in a single carton.

Spacers

The Extra Width Double-Row Angular Contact Ball Bearing Retrofit Kit is simple to use. When used with bearings without snap rings, place both spacers on the same side, as shown in Figure 1.

With snap ring bearings, the inner ring spacer must be installed on the side opposite the snap ring, as shown in Figure 2. The outer spacer is not needed in applications where the bearing's snap ring controls the axial location of the outer ring in the housing.

The spacers accommodate slight variations in the shaft and housing seat width. The inner ring and spacer can be secured to the shaft with a retaining ring or threaded

locknut. If a locknut is used, the amount of clamping force can be regulated to make slight adjustments in the shaft's axial location. The spacer rings yield slightly when an axial clamping force is applied. The spacer rings also exert a reaction force, which helps maintain the initial clamping force and helps prevent the inner ring from becoming loose on the shaft. The same circumstances apply to the outer ring spacers when an end cap is used to clamp the bearing's outer ring against a housing shoulder.

Because the spacer rings are designed to yield slightly when axial clamping forces are applied, the spacer rings should always be replaced with new spacer rings anytime the bearing is removed, replaced or reinstalled.

Materials for Rings, Balls and Spacers

High-carbon chromium vacuum-processed steel (SAE 52100) is used for all balls and rings. Machined and roll formed spacer rings are fabricated from 1018 carbon steel and 304 stainless steel.

Mounting Instructions

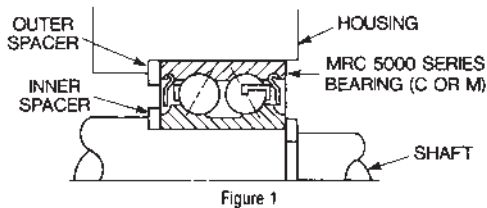

Figure 1

Without Snap Ring

1. Install inner and outer ring spacers onto the shaft and into the housing bore respectively.
2. Install bearing in accordance with normal mounting instructions.
3. If any locking devices such as snap rings or locknuts are normally used to secure the bearing on the shaft or in the housing be sure they are properly installed.
4. These inner and outer ring spacers are adjusted to proper width prior to installation. During bearing installation their width may be slightly altered to accommodate variations in shaft and housing shoulder distances. As a consequence, when a new extra width retrofit bearing kit is installed the new spacer rings supplied with the kit should always be used and the old spacers discarded.

Mounting Instructions

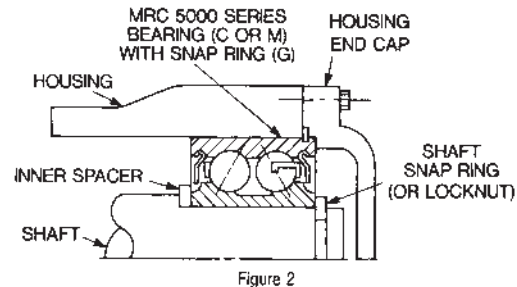

Figure 2

With Snap Ring

1. Install the inner ring spacer onto the shaft. The outer ring spacer is not used with a snap ring bearing and may be discarded.
2. Install bearing in accordance with normal mounting instructions.
3. If any locking devices such as snap rings, locknuts or end caps are normally used to secure the bearing on the shaft or in the housing be sure they are properly installed.
4. These inner and outer ring spacers are adjusted to proper width prior to installation. During bearing installation their width may be slightly altered to accommodate variations in shaft and housing shoulder distances. As a consequence, when a new extra width retrofit bearing kit is installed the new spacer rings supplied with the kit should always be used and the old spacers discarded.

Extra Wide 5000 Series

Part Numbers

MRC Bearing Services

A listing of available part numbers appears below. This listing may change with sizes being added or deleted based on demand.

MRC Part Number	Width including Spacers		
	Inches	mm	
5205CF1	7/8	.8750	22.23
5205MF1	7/8	.8750	22.23
5206CF1	1 1/16	1.0625	26.99
5206MF1	1 1/16	1.0625	26.99
5206SBZZ*	1 1/16	1.0625	26.99
5212MF1	1 1/2	1.5000	38.10
5304CF1	1	1.0000	25.40
5304MF1	1	1.0000	25.40
5305CF1	1 1/8	1.1250	28.58
5305MFG1	1 1/8	1.1250	28.58
5306MFG1	1 5/16	1.3125	33.34
5306MF1	1 5/16	1.3125	33.34
5307MF1	1 1/2	1.5000	38.10
5307MFG1	1 1/2	1.5000	38.10
5308MFG1	1 9/16	1.5625	39.69
5308MF1	1 9/16	1.5625	39.69
5309MFG1	1 11/16	1.6875	42.86
5309MF1	1 11/16	1.6875	42.86
5310MFG1	1 7/8	1.8750	47.63
5310MF1	1 7/8	1.8750	47.63
5311MFG1	2 1/16	2.0625	52.39
5311MF1	2 1/16	2.0625	52.39
5312MFG1	2 1/4	2.2500	57.15
5312MF1	2 1/4	2.2500	57.15
5313MFG1	2 7/16	2.4375	61.91
5313MF1	2 7/16	2.4375	61.91
5315MF1	2 13/16	2.8125	71.44

*Currently stocked. No spacer needed.

Nomenclature

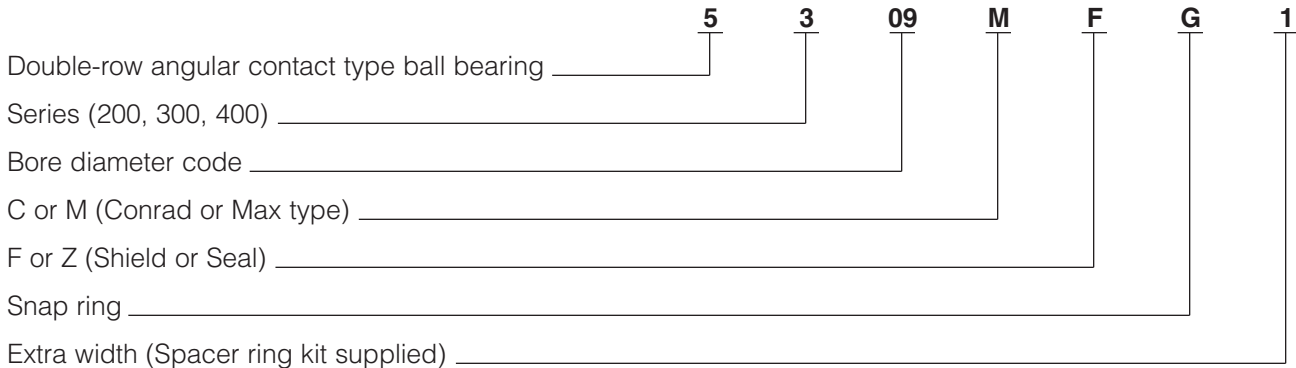

5200-C bearings are used with moderate to heavy radial loads, two-directional thrust loads, or a combination of both.

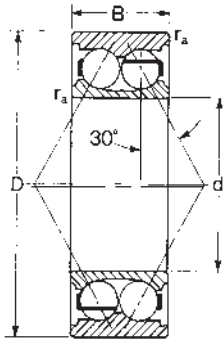

MRC Bearing Number	Bore		Outside Diameter		Width		Fillet Radius ¹⁾		Basic Radial Load Rating				Speed Rating ²⁾		
	d	in	D	in	B	in	r _a	in	Dynamic C ³⁾		Static C ₀		Open and Shielded Oil		Single and Double Sealed Grease
									N	lbf	N	lbf	RPM	RPM	RPM
5200-SB	10	.3937	30	1.1811	14.29	.5625	.64	.025	7 610	1 710	4 300	967	16 000	22 000	16 000
5201-SB	12	.4724	32	1.2598	15.88	.6250	.64	.025	10 400	2 340	5 600	1 260	15 000	20 000	15 000
5202-SB	15	.5906	35	1.3780	15.88	.6250	.64	.025	11 400	2 560	6 800	1 530	12 000	17 000	12 000
5203-SB	17	.6693	40	1.5748	17.47	.6876	.64	.025	14 300	3 210	8 800	1 980	10 000	15 000	10 000
5204-C	20	.7874	47	1.8504	20.64	.8125	1.0	.04	19 000	4 270	12 000	2 700	9 000	13 000	9 000
5205-C	25	.9843	52	2.0472	20.64	.8125	1.0	.04	20 800	4 680	14 000	3 150	8 000	11 000	8 000
5205-C1	25	.9843	52	2.0472	22.23	.8750	1.0	.04	20 800	4 680	14 000	3 150	8 000	11 000	8 000
5206-C	30	1.1811	62	2.4409	23.81	.9375	1.0	.04	28 600	6 430	20 400	4 590	7 000	9 500	7 000
5206-C1	30	1.1811	62	2.4409	26.99	1.0625	1.0	.04	28 600	6 430	20 400	4 590	7 000	9 500	7 000
5207-C	35	1.3780	72	2.8346	26.99	1.0625	1.0	.04	37 700	8 480	27 500	6 180	6 000	8 000	6 000
5207-C1	35	1.3780	72	2.8346	30.16	1.1875	1.0	.04	37 700	8 480	27 500	6 180	6 000	8 000	6 000
5208-C	40	1.5748	80	3.1496	30.16	1.1875	1.0	.04	44 900	10 100	34 000	7 640	5 600	7 500	5 600
5209-C	45	1.7717	85	3.3465	30.16	1.1875	1.0	.04	48 800	11 000	39 000	8 770	5 000	6 700	5 000
5210-C	50	1.9685	90	3.5433	30.16	1.1875	1.0	.04	48 800	11 000	39 000	8 770	4 800	6 300	4 800
5211-C	55	2.1654	100	3.9370	33.34	1.3125	1.5	.06	57 200	12 900	47 500	10 700	4 300	5 600	4 300
5212-C	60	2.3622	110	4.3307	36.51	1.4375	1.5	.06	70 200	15 800	58 500	13 200	3 800	5 000	3 800
5212-C1	60	2.3622	110	4.3307	38.10	1.5000	1.5	.06	70 200	15 800	58 500	13 200	3 800	5 000	3 800
5213-C	65	2.5591	120	4.7244	38.10	1.5000	1.5	.06	80 600	18 100	73 500	16 500	3 600	4 800	3 600
5214-C	70	2.7559	125	4.9213	39.69	1.5625	1.5	.06	88 400	19 900	80 000	18 000	3 200	4 300	3 200
5215-C	75	2.9528	130	5.1181	41.28	1.6250	1.5	.06	95 600	21 500	88 000	19 800	3 200	4 300	3 200
5216-C	80	3.1496	140	5.5118	44.45	1.7500	2.0	.08	106 000	23 900	95 000	21 400	2 800	3 800	2 800
5217-C	85	3.3465	150	5.9055	49.21	1.9375	2.0	.08	124 000	27 900	110 000	24 700	2 600	3 600	2 600
5218-C	90	3.5433	160	6.2992	52.39	2.0625	2.0	.08	130 000	29 300	120 000	27 000	2 400	3 400	2 400
5219-C	95	3.7402	170	6.6929	55.56	2.1875	2.0	.08	159 000	35 700	146 000	32 800	2 200	3 200	2 200
5220-C	100	3.9370	180	7.0866	60.33	2.3750	2.0	.08	178 000	40 000	166 000	37 300	2 000	3 000	2 000
5221-C	105	4.1339	190	7.4803	65.09	2.5625	2.0	.08	186 000	41 800	180 000	40 500	1 800	2 800	1 800
5222-C	110	4.3307	200	7.8740	69.85	2.7500	2.0	.08	203 000	45 600	200 000	45 000	1 600	2 600	1 600

¹⁾ Fillet radius indicates maximum fillet radius on shaft or in housing which bearing corner will clear.

²⁾ Listed values are for pressed steel cage, ABEC-1.

The values have been determined through historical application and practice. For a more complete explanation, see page 274.

³⁾ Rating for one million revolutions or 500 hours at 33 1/3 RPM.

Note: Extra width bearings identified by the suffix C1 are supplied with a retrofit kit described on pages 91, 92.

5300-C bearings are used with heavy radial loads, two-directional thrust loads, or a combination of both.

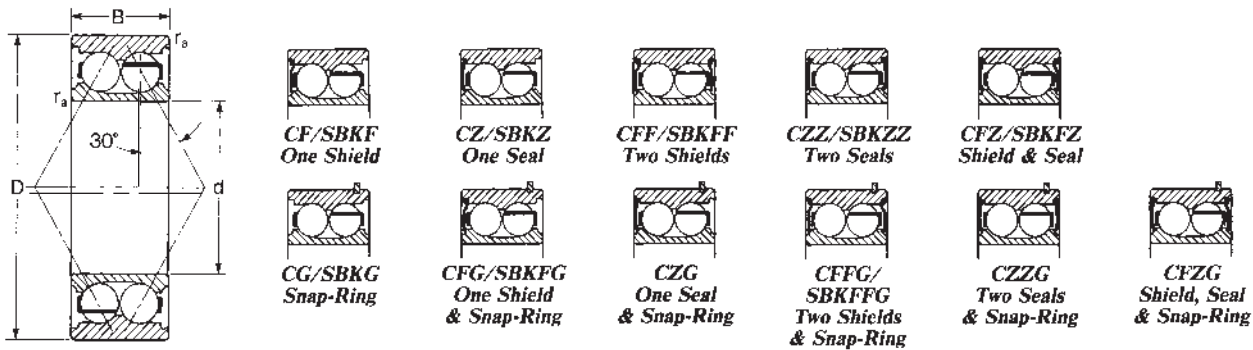

MRC Bearing Number	Bore		Outside Diameter D		Width B		Fillet Radius ¹⁾ r _a		Basic Radial Load Rating				Speed Rating ²⁾		
	d mm	in	mm	in	mm	in	mm	in	Dynamic C ³⁾		Static C ₀		Open and Shielded Grease		Single and Double Sealed Grease
									N	lbf	N	lbf	RPM	RPM	RPM
5300-SB	10	.3937	35	1.3780	19.05	.7500	.64	.025	10 600	2 380	6 100	1 370	15 000	20 000	15 000
5301-SB	12	.4724	37	1.4567	19.05	.7500	1.0	.04	11 700	2 630	6 800	1 530	14 000	18 000	14 000
5302-SB	15	.5906	42	1.6535	19.05	.7500	1.0	.04	15 100	3 390	9 300	2 090	11 000	15 000	11 000
5303-SB	17	.6693	47	1.8504	22.23	.8750	1.0	.04	21 600	4 860	12 700	2 860	11 000	14 000	11 000
5304-C	20	.7874	52	2.0472	22.23	.8750	1.0	.04	22 500	5 060	14 600	3 280	8 500	12 000	8 500
5304-C1	20	.7874	52	2.0472	25.40	1.0000	1.0	.04	22 500	5 060	14 600	3 280	8 500	12 000	8 500
5305-C	25	.9843	62	2.4409	25.40	1.0000	1.0	.04	30 700	6 910	20 400	4 590	7 500	10 000	7 500
5306-C	30	1.1811	72	2.8346	30.16	1.1875	1.0	.04	41 600	9 360	29 000	6 520	6 300	8 500	6 300
5306-C1	30	1.1811	72	2.8346	33.34	1.3125	1.0	.04	41 600	9 360	29 000	6 520	6 300	8 500	6 300
5307-C	35	1.3780	80	3.1496	34.93	1.3750	1.5	.06	49 400	11 100	34 500	7 760	5 600	7 500	5 600
5307-C1	35	1.3780	80	3.1496	38.10	1.5000	1.5	.06	49 400	11 100	34 500	7 760	5 600	7 500	5 600
5308-C	40	1.5748	90	3.5433	36.51	1.4375	1.5	.06	60 500	13 600	43 000	9 760	5 000	6 700	5 000
5308-C1	40	1.5748	90	3.5433	39.69	1.5625	1.5	.06	60 500	13 600	43 000	9 760	5 000	6 700	5 000
5309-C	45	1.7717	100	3.9370	39.69	1.5625	1.5	.06	72 800	16 400	53 000	11 900	4 500	6 000	4 500
5309-C1	45	1.7717	100	3.9370	42.86	1.6875	1.5	.06	72 800	16 400	53 000	11 900	4 500	6 000	4 500
5310-C	50	1.9685	110	4.3307	44.45	1.7500	2.0	.08	85 200	19 200	64 000	14 400	4 000	5 300	4 000
5310-C1	50	1.9685	110	4.3307	47.63	1.8750	2.0	.08	85 200	19 200	64 000	14 400	4 000	5 300	4 000
5311-C	55	2.1654	120	4.7244	49.21	1.9375	2.0	.08	106 000	23 900	81 500	18 300	3 800	5 000	3 800
5311-C1	55	2.1654	120	4.7244	52.39	2.0625	2.0	.08	106 000	23 900	81 500	18 300	3 800	5 000	3 800
5312-C	60	2.3622	130	5.1181	53.98	2.1250	2.0	.08	121 000	27 200	95 000	21 400	3 400	4 500	3 400
5312-C1	60	2.3622	130	5.1181	57.15	2.2500	2.0	.08	121 000	27 200	95 000	21 400	3 400	4 500	3 400
5313-C	65	2.5591	140	5.5118	58.74	2.3125	2.0	.08	138 000	31 100	108 000	24 300	3 200	4 300	3 200
5313-C1	65	2.5591	140	5.5118	61.91	2.4375	2.0	.08	138 000	31 100	108 000	24 300	3 200	4 300	3 200
5314-C	70	2.7559	150	5.9055	63.50	2.5000	2.0	.08	153 000	34 400	125 000	28 100	2 800	3 800	2 800
5314-C1	70	2.7559	150	5.9055	66.68	2.6250	2.0	.08	153 000	34 400	125 000	28 100	2 800	3 800	2 800
5315-C	75	2.9528	160	6.2992	68.26	2.6875	2.0	.08	168 000	37 800	140 000	31 500	2 600	3 600	2 600
5315-C1	75	2.9528	160	6.2992	71.44	2.8125	2.0	.08	168 000	37 800	140 000	31 500	2 600	3 600	2 600
5316-C	80	3.1496	170	6.6929	68.26	2.6875	2.0	.08	182 000	41 000	156 000	35 100	2 400	3 400	2 400
5317-C	85	3.3465	180	7.0866	73.03	2.8750	2.5	.10	195 000	43 900	176 000	39 600	2 200	3 200	2 200
5318-C	90	3.5433	190	7.4803	73.03	2.8750	2.5	.10	212 000	47 700	196 000	44 100	2 000	3 000	2 000
5319-C	95	3.7402	200	7.8740	77.79	3.0625	2.5	.10	234 000	52 700	224 000	50 400	1 900	2 800	1 900
5320-C	100	3.9370	215	8.4646	82.55	3.2500	2.5	.10	255 000	57 300	255 000	57 300	1 800	2 600	1 800
5322-C	110	4.3307	240	9.4488	92.08	3.6250	2.5	.10	291 000	65 400	305 000	68 600	1 700	2 400	1 700

¹⁾ Fillet radius indicates maximum fillet radius on shaft or in housing which bearing corner will clear.

²⁾ Listed values are for pressed steel cage, ABEC-1.

The values have been determined through historical application and practice. For a more complete explanation, see page 274.

³⁾ Rating for one million revolutions or 500 hours at 33 1/3 RPM.

Note: Extra width bearings identified by the suffix C1 are supplied with a retrofit kit described on pages 91, 92.

5400 Series bearings are used with extremely heavy radial loads, two-directional thrust loads, or a combination of both.

5406-5414 have a 24° contact angle per row.

5415-5418 have a 0° contact angle.

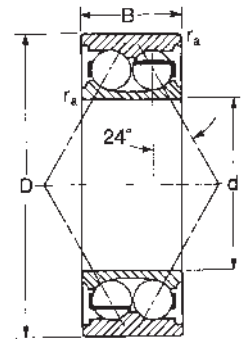

MRC Bearing Number	Bore		Outside Diameter D		Width B		Fillet Radius ¹⁾ r _a		Basic Radial Load Rating				Speed Rating ²⁾		
									Dynamic C ³⁾		Static C ₀		Grease	Oil	
	d	mm	in	mm	in	mm	in	mm	in	N	lbf	N	lbf	RPM	RPM
5406C	30		1.1811	90	3.5433	39.69	1.5625	1.5	.06	67 600	15 200	45 000	10 100	5 300	7 000
5407C	35		1.3780	100	3.9370	44.45	1.7500	1.5	.06	76 100	17 000	49 000	11 000	4 800	6 300
5408C	40		1.5748	110	4.3307	49.21	1.9375	2.0	.08	88 400	19 900	57 000	12 800	4 300	5 600
5409C	45		1.7717	120	4.7244	53.98	2.1250	2.0	.08	112 000	25 200	78 000	17 600	4 000	5 300
5410C	50		1.9685	130	5.1181	58.74	2.3125	2.0	.08	143 000	32 200	102 000	23 000	3 600	4 800
5411C	55		2.1654	140	5.5118	63.50	2.5000	2.0	.08	146 000	32 900	102 000	23 000	3 200	4 300
5412C	60		2.3622	150	5.9055	66.68	2.6250	2.0	.08	159 000	35 800	114 000	25 700	3 000	4 000
5413C	65		2.5591	160	6.2992	71.44	2.8125	2.0	.08	195 000	43 900	156 000	35 100	2 800	3 800
5414C	70		2.7559	180	7.0866	79.38	3.1250	2.5	.10	199 000	44 800	156 000	35 100	2 400	3 400
5415C	75		2.9528	190	7.4803	82.55	3.2500	2.5	.10	212 000	47 700	200 000	45 000	2 200	3 200
5416C	80		3.1496	200	7.8740	87.31	3.4375	2.5	.10	229 000	51 500	216 000	48 600	2 000	3 000
5417C	85		3.3465	210	8.2677	92.08	3.6250	3.0	.12	255 000	57 300	255 000	57 300	1 900	2 800
5418C	90		3.5433	225	8.8583	98.43	3.8750	3.0	.12	281 000	63 200	300 000	67 400	1 800	2 600

¹⁾ Fillet radius indicates maximum fillet radius on shaft or in housing which bearing corner will clear.

²⁾ Listed values are for pressed steel cage, ABEC-1.

The values have been determined through historical application and practice. For a more complete explanation, see page 274.

³⁾ Rating for one million revolutions or 500 hours at 33 1/3 RPM.

5200M bearings are used with heavy radial loads, two-directional thrust loads, or a combination of both. Thrust load should be carried on the non-filling notch row. Moderate thrust load is permissible on the filling notch row.

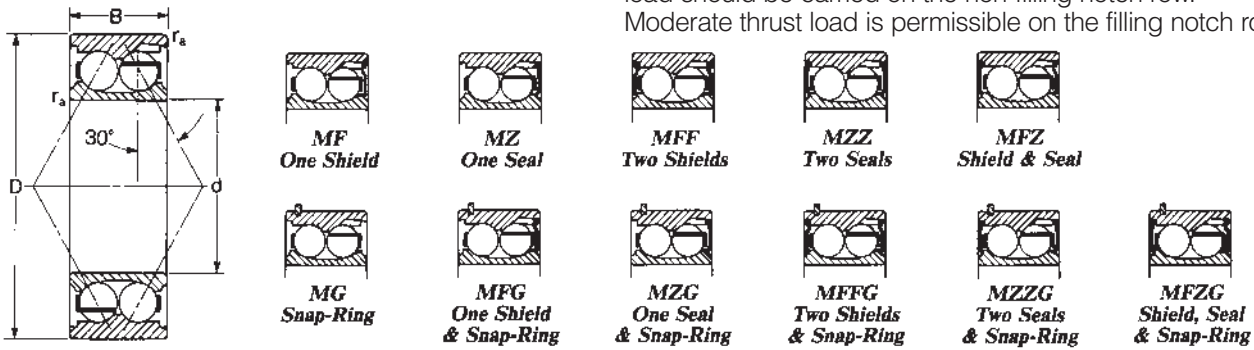

MRC Bearing Number	Bore		Outside Diameter D		Width B		Fillet Radius ¹⁾ r _a	Basic Radial Load Rating				Speed Rating ²⁾			
	d	in	mm	in	mm	in		Dynamic C ³⁾		Static C ₀		Open and Shielded Grease		Single and Double Sealed Grease	
								N	lbf	N	lbf	RPM	RPM	RPM	
5204-M	20	.7874	47	1.8504	20.64	.8125	1.0	.04	20 500	4 610	17 000	3 820	9 000	13 000	9 000
5205-M	25	.9843	52	2.0472	20.64	.8125	1.0	.04	22 900	5 150	21 200	4 770	8 000	11 000	8 000
5205-M1	25	.9843	52	2.0472	22.23	.8750	1.0	.04	22 900	5 150	21 200	4 770	8 000	11 000	8 000
5206-M	30	1.1811	62	2.4409	23.81	.9375	1.0	.04	30 300	6 820	28 000	6 290	7 000	9 500	7 000
5206-M1	30	1.1811	62	2.4409	26.99	1.0625	1.0	.04	30 300	6 820	28 000	6 290	7 000	9 500	7 000
5207-M	35	1.3780	72	2.8346	26.99	1.0625	1.0	.04	39 100	8 800	36 500	8 210	6 000	8 000	6 000
5207-M1	35	1.3780	72	2.8346	30.16	1.1875	1.0	.04	39 100	8 800	36 500	8 210	6 000	8 000	6 000
5208-M	40	1.5748	80	3.1496	30.16	1.1875	1.0	.04	49 500	11 100	49 000	11 000	5 600	7 500	5 600
5209-M	45	1.7717	85	3.3465	30.16	1.1875	1.0	.04	51 200	11 500	54 000	12 100	5 000	6 700	5 000
5210-M	50	1.9685	90	3.5433	30.16	1.1875	1.0	.04	53 900	12 100	58 500	13 200	4 800	6 300	4 800
5211-M	55	2.1654	100	3.9370	33.34	1.3125	1.5	.06	66 000	14 900	76 500	17 200	4 300	5 600	4 300
5212-M	60	2.3622	110	4.3307	36.51	1.4375	1.5	.06	78 100	17 600	88 000	19 800	3 800	5 000	3 800
5212-M1	60	2.3622	110	4.3307	38.10	1.5000	1.5	.06	78 100	17 600	88 000	19 800	3 800	5 000	3 800
5213-M	65	2.5591	120	4.7244	38.10	1.5000	1.5	.06	88 000	19 800	106 000	23 800	3 600	4 800	3 600
5214-M	70	2.7559	125	4.9213	39.69	1.5625	1.5	.06	101 000	22 700	125 000	28 100	3 200	4 300	3 200
5215-M	75	2.9528	130	5.1181	41.28	1.6250	1.5	.06	108 000	24 300	137 000	30 800	3 200	4 300	3 200
5216-M	80	3.1496	140	5.5118	44.45	1.7500	2.0	.08	128 000	28 800	160 000	36 000	2 800	3 800	2 800
5217-M	85	3.3465	150	5.9055	49.21	1.9375	2.0	.08	142 000	32 000	176 000	39 600	2 600	3 600	2 600
5218-M	90	3.5433	160	6.2992	52.39	2.0625	2.0	.08	151 000	34 000	193 000	43 400	2 400	3 400	2 400

¹⁾ Fillet radius indicates maximum fillet radius on shaft or in housing which bearing corner will clear.

²⁾ Listed values are for pressed steel cage, ABEC-1.

The values have been determined through historical application and practice. For a more complete explanation, see page 274.

³⁾ Rating for one million revolutions or 500 hours at 33 1/3 RPM.

Note: Extra width bearings identified by the suffix M1 are supplied with a retrofit kit described on pages 91, 92.

5300M bearings are used with heavy radial loads, two-directional thrust loads, or a combination of both. Thrust load should be carried on the non-filling notch row. Moderate thrust load is permissible on the filling notch row.

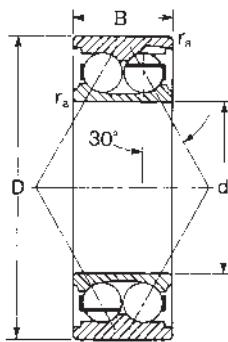

MRC Bearing Number	Bore		Outside Diameter		Width		Fillet Radius ¹⁾		Basic Radial Load Rating				Speed Rating ²⁾		
	d	in	D	in	B	in	r _a	in	Dynamic C ³⁾		Static C ₀		Open and Shielded Oil		Single and Double Sealed Grease
									N	lbf	N	lbf	RPM	RPM	RPM
5304-M	20	.7874	52	2.0472	22.23	.8750	1.0	.04	23 800	5 360	20 000	4 500	8 500	12 000	8 500
5304-M1	20	.7874	52	2.0472	25.40	1.0000	1.0	.04	23 800	5 360	20 000	4 500	8 500	12 000	8 500
5305-M	25	.9843	62	2.4409	25.40	1.0000	1.0	.04	34 100	7 670	30 500	6 860	7 500	10 000	7 500
5306-M	30	1.1811	72	2.8346	30.16	1.1875	1.0	.04	46 800	10 500	43 000	9 670	6 300	8 500	6 300
5306-M1	30	1.1811	72	2.8346	33.34	1.3125	1.0	.04	46 800	10 500	43 000	9 670	6 300	8 500	6 300
5307-M	35	1.3780	80	3.1496	34.93	1.3750	1.5	.06	52 300	11 800	48 000	10 800	5 600	7 500	5 600
5307-M1	35	1.3780	80	3.1496	38.10	1.5000	1.5	.06	52 300	11 800	48 000	10 800	5 600	7 500	5 600
5308-M	40	1.5748	90	3.5433	36.51	1.4375	1.5	.06	67 100	15 100	65 500	14 700	5 000	6 700	5 000
5308-M1	40	1.5748	90	3.5433	39.69	1.5625	1.5	.06	67 100	15 100	65 500	14 700	5 000	6 700	5 000
5309-M	45	1.7717	100	3.9370	39.69	1.5625	1.5	.06	80 900	18 200	80 000	18 000	4 500	6 000	4 500
5309-M1	45	1.7717	100	3.9370	42.86	1.6875	1.5	.06	80 900	18 200	80 000	18 000	4 500	6 000	4 500
5310-M	50	1.9685	110	4.3307	44.45	1.7500	2.0	.08	95 200	21 400	95 000	21 400	4 000	5 300	4 000
5310-M1	50	1.9685	110	4.3307	47.63	1.8750	2.0	.08	95 200	21 400	95 000	21 400	4 000	5 300	4 000
5311-M	55	2.1654	120	4.7244	49.21	1.9375	2.0	.08	119 000	26 800	122 000	27 400	3 800	5 000	3 800
5311-M1	55	2.1654	120	4.7244	52.39	2.0625	2.0	.08	119 000	26 800	122 000	27 400	3 800	5 000	3 800
5312-M	60	2.3622	130	5.1181	53.98	2.1250	2.0	.08	134 000	30 200	143 000	32 100	3 400	4 500	3 400
5312-M1	60	2.3622	130	5.1181	57.15	2.2500	2.0	.08	134 000	30 200	143 000	32 100	3 400	4 500	3 400
5313-M	65	2.5591	140	5.5118	58.74	2.3125	2.0	.08	154 000	34 700	163 000	36 600	3 200	4 300	3 200
5313-M1	65	2.5591	140	5.5118	61.91	2.4375	2.0	.08	154 000	34 700	163 000	36 600	3 200	4 300	3 200
5314-M	70	2.7559	150	5.9055	63.50	2.5000	2.0	.08	172 000	38 700	186 000	41 800	2 800	3 800	2 800
5314-M1	70	2.7559	150	5.9055	66.68	2.6250	2.0	.08	172 000	38 700	186 000	41 800	2 800	3 800	2 800
5315-M	75	2.9528	160	6.2992	68.26	2.6875	2.0	.08	187 000	42 000	208 000	46 800	2 600	3 600	2 600
5315-M1	75	2.9528	160	6.2992	71.44	2.8125	2.0	.08	187 000	42 000	208 000	46 800	2 600	3 600	2 600
5316-M	80	3.1496	170	6.6929	68.26	2.6875	2.0	.08	201 000	45 200	236 000	53 100	2 400	3 400	2 400
5317	85	3.3465	180	7.0866	73.03	2.8750	2.5	.10	198 000	44 500	245 000	55 100	2 200	3 200	2 200
5318	90	3.5433	190	7.4803	73.03	2.8750	2.5	.10	224 000	50 400	290 000	65 200	2 000	3 000	2 000
5319	95	3.7402	200	7.8740	77.79	3.0625	2.5	.10	242 000	54 400	315 000	70 800	1 900	2 800	1 900

¹⁾ Fillet radius indicates maximum fillet radius on shaft or in housing which bearing corner will clear.

²⁾ Listed values are for pressed steel cage, ABEC-1.

The values have been determined through historical application and practice. For a more complete explanation, see page 274.

³⁾ Rating for one million revolutions or 500 hours at 33 1/3 RPM.

Note: Extra width bearings identified by the suffix M1 are supplied with a retrofit kit described on pages 91, 92.

5300-UPG Series Double-Row Angular Contact Ball Bearings

MRC Bearing Services

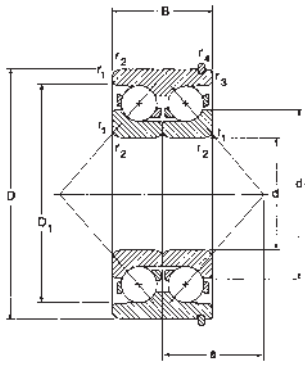

5300 UPG series bearings are a specialized double-row angular contact design developed specifically for pump applications. The bearings are capable of carrying axial loads in either direction, radial loads, or a combination of both. Machined brass cages, ABEC 3 tolerances, 40° contact angle and reduced (“CB”) end play are standard features selected to improve performance for these bearings.

The MRC 5300 UPG Series is “The Pump Bearing”

MRC Bearing Number	Bore		Outside Diameter D		Width B		Fillet Radius ¹⁾ r _a		Basic Radial Load Rating				Speed Rating	
	d								Dynamic C ²⁾		Static C ₀		Grease	Oil
	mm	in	mm	in	mm	in	mm	in	N	lbf	N	lbf	RPM	RPM
5308UPG	40	1.5748	90	3.5433	36.51	1.4375	1.5	0.06	49 400	11 110	41 500	9 330	5 000	6 700
5309UPG	45	1.7717	100	3.9370	39.69	1.5625	1.5	0.06	61 800	13 890	52 000	11 690	4 500	6 000
5310UPG	50	1.9685	110	4.3307	44.45	1.7500	2.0	0.08	81 900	18 410	69 500	15 620	4 000	5 300
5311UPG	55	2.1654	120	4.7244	49.21	1.9375	2.0	0.08	95 600	21 490	83 000	18 660	3 800	5 000
5313UPG	65	2.5591	140	5.5118	58.74	2.3125	2.1	0.08	138 000	31 000	122 000	27 400	3 200	4 300

¹⁾ Fillet radius indicates maximum fillet radius on shaft or in housing which bearing corner will clear.

²⁾ Rating for one million revolutions or 500 hours at 33¹/₃ RPM.

Dynamic and static equivalent radial load and life rating

Dynamic equivalent radial load

$P = XF_R + YF_A$ P = Dynamic equivalent radial load
 F_R = Radial load
 F_A = Thrust load
 X = Radial load factor
 Y = Thrust load factor
 C_0 = Basic static radial load rating
 e = Limiting factor for F_A/F_R

Size	e	$F_A/F_R \leq e$		$F_A/F_R > e$	
		X	Y	X	Y
5200SB-5206C&M 5300SB-5303SB 5403C-5414C	0.66	1.0	0.92	0.67	1.41
5207C&M-5218C&M 5304C&M-5319C&M	0.80	1.0	0.78	0.63	1.24
5308UPG-5313UPG	1.14	1.0	0	0.35	0.57

Size	F_A/C_0	Normal Clearance (ST Fit)			C3 Clearance (LO Fit)		
		e	X	Y	e	X	Y
5415C-5419C	0.025	0.22	0.56	2.0	0.25	0.52	1.8
	0.040	0.24	0.56	1.8	0.28	0.52	1.65
	0.070	0.27	0.56	1.6	0.30	0.52	1.5
	0.13	0.31	0.56	1.4	0.34	0.52	1.33
	0.25	0.37	0.56	1.2	0.40	0.52	1.17
	0.50	0.44	0.56	1.0	0.48	0.52	1.0

Values of Y and e for loads not shown are obtained by linear interpolation.

Life Rating

$$L_{10} = \left(\frac{C}{P}\right)^3 \text{ (Millions of revolutions)}$$

or

$$L_{10h} = \frac{10^6}{60n} \left(\frac{C}{P}\right)^3 \text{ (Hours)}$$

C = Basic dynamic load rating
 P = Dynamic equivalent radial load
 n = Speed in RPM

Static equivalent radial load

$P_0 = X_0F_R + Y_0F_A$ P_0 = Static equivalent radial load
 F_R = Radial load
 F_A = Thrust load
 X_0 = Radial load factor
 Y_0 = Thrust load factor

Size	X_0	Y_0
5200SB-5206C&M 5300SB-5303SB 5403C-5414C	1.0	0.76
5207C&M-5218C&M 5304C&M-5319C&M	1.0	0.66
5308-5313UPG	0.50	0.26
5415C-5419C	0.60	0.50

P_0 is always $\geq F_R$

Minimum Radial Load

To insure satisfactory operation of double row, angular contact ball bearings, they must be subjected to a minimum radial load, which is especially true at high speeds where inertia forces of the balls and cage, and the friction in the lubricant, can cause skidding to occur between the balls and raceway.

The required minimum radial load can be estimated from:

$$F_{r,m} = K_r \left(\frac{\gamma n}{1000}\right)^{2/3} \left(\frac{d_m}{100}\right)^2$$

$F_{r,m}$ = Minimum radial load (N)
 K_r = Minimum load factor

Series	K_r
5200SB&C	60
5200M	90
5300SB&C	70
5300M	110
5400C	70

γ = Oil viscosity at operating temperature (cSt)
 n = Speed in RPM

$$d_m = \text{Mean bearing diameter} = \left(\frac{D+d}{2}\right), (\text{mm})$$

D = Bearing outside diameter (mm)
 d = Bearing inside diameter (mm)

**Dynamic equivalent radial load
and life calculation examples**

Bearing size: 5210 M
Speed: 2000 RPM
Basic dynamic radial load rating (C) = 12100

Bearing size: 5203 SB
Speed: 2000 RPM
Basic dynamic radial load rating (C) = 3210

Case 1

Radial load (F_R) = 1750
 $F_A/F_R = 0/1750 = 0$
Equivalent load (P) = $X F_R + Y F_A$
Since $F_A/F_R < e$, equivalent load
(P) = $1.0 F_R + 0.78 F_A = 1.0 \times 1750 = 1750$
Life (L10) = $\left(\frac{C}{P}\right)^3 = \left(\frac{12100}{1750}\right)^3 = 331 \times 10^6$ Rev.
or
Life (L10h) = $\frac{10^6(C)^3}{60n(P)^3} = \frac{10^6}{60 \times 2000} \left(\frac{12100}{1750}\right)^3$
= 2755 Hrs

Case 1

Radial load (F_R) = 500
 $F_A/F_R = 0/500 = 0$
Equivalent load (P) = $X F_R + Y F_A$
Since $F_A/F_R < e$, equivalent load
(P) = $1.0 F_R + 0.92 F_A = 1.0 \times 500 = 500$
Life (L10) = $\left(\frac{C}{P}\right)^3 = \left(\frac{3210}{500}\right)^3 = 265 \times 10^6$ Rev.
or
Life (L10h) = $\frac{10^6(C)^3}{60n(P)^3} = \frac{10^6}{60 \times 2000} \left(\frac{3210}{500}\right)^3$
= 2205 Hrs

Case 2

Radial load (F_R) = 1750
Thrust load (F_A) = 1300
 $F_A/F_R = 1300/1750 = 0.74$
Equivalent load (P) = $X F_R + Y F_A$
Since $F_A/F_R < e$, equivalent load
(P) = $1.0 F_R + 0.78 F_A = 1.0 \times 1750 + 0.78 \times 1300 = 2764$
Life (L10) = $\left(\frac{C}{P}\right)^3 = \left(\frac{12100}{2764}\right)^3 = 83.9 \times 10^6$ Rev.
or
Life (L10h) = $\frac{10^6(C)^3}{60n(P)^3} = \frac{10^6}{60 \times 2000} \left(\frac{12100}{2764}\right)^3$
= 699 Hrs

Case 2

Radial load (F_R) = 500
Thrust load (F_A) = 325
 $F_A/F_R = 325/500 = 0.65$
Equivalent load (P) = $X F_R + Y F_A$
Since $F_A/F_R < e$, equivalent load
(P) = $1.0 F_R + 0.92 F_A = 1.0 \times 500 + 0.92 \times 325 = 799$
Life (L10) = $\left(\frac{C}{P}\right)^3 = \left(\frac{3210}{799}\right)^3 = 64.8 \times 10^6$ Rev.
or
Life (L10h) = $\frac{10^6(C)^3}{60n(P)^3} = \frac{10^6}{60 \times 2000} \left(\frac{3210}{799}\right)^3$
= 540 Hrs

Case 3

Radial load (F_R) = 1750
Thrust load (F_A) = 1500
 $F_A/F_R = 1500/1750 = 0.86$
Equivalent load (P) = $X F_R + Y F_A$
Since $F_A/F_R > e$, equivalent load
(P) = $0.63 F_R + 1.24 F_A$
= $0.63 \times 1750 + 1.24 \times 1500 = 2963$
Life (L10) = $\left(\frac{C}{P}\right)^3 = \left(\frac{12100}{2963}\right)^3 = 68.1 \times 10^6$ Rev.
or
Life (L10h) = $\frac{10^6(C)^3}{60n(P)^3} = \frac{10^6}{60 \times 2000} \left(\frac{12100}{2963}\right)^3$
= 568 Hrs

Case 3

Radial load (F_R) = 500
Thrust load (F_A) = 375
 $F_A/F_R = 375/500 = 0.75$
Equivalent load (P) = $X F_R + Y F_A$
Since $F_A/F_R > e$, equivalent load
(P) = $0.67 F_R + 1.41 F_A$
= $0.67 \times 500 + 1.41 \times 375 = 864$
Life (L10) = $\left(\frac{C}{P}\right)^3 = \left(\frac{3210}{864}\right)^3 = 51.3 \times 10^6$ Rev.
or
Life (L10h) = $\frac{10^6(C)^3}{60n(P)^3} = \frac{10^6}{60 \times 2000} \left(\frac{3210}{864}\right)^3$
= 427 Hrs

Case 4

Thrust load (F_A) = 1500
 $F_A/F_R = 1500/0 = \infty$
Equivalent load (P) = $X F_R + Y F_A$
Since $F_A/F_R > e$, equivalent load
(P) = $0.63 F_R + 1.24 F_A = 1.24 \times 1500 = 1860$
Life (L10) = $\left(\frac{C}{P}\right)^3 = \left(\frac{12100}{1860}\right)^3 = 275 \times 10^6$ Rev.
or
Life (L10h) = $\frac{10^6(C)^3}{60n(P)^3} = \frac{10^6}{60 \times 2000} \left(\frac{12100}{1860}\right)^3$
= 2294 Hrs

Case 4

Thrust load (F_A) = 375
 $F_A/F_R = 375/0 = \infty$
Equivalent load (P) = $X F_R + Y F_A$
Since $F_A/F_R > e$, equivalent load
(P) = $0.67 F_R + 1.41 F_A = 1.41 \times 375 = 529$
Life (L10) = $\left(\frac{C}{P}\right)^3 = \left(\frac{3210}{529}\right)^3 = 223 \times 10^6$ Rev.
or
Life (L10h) = $\frac{10^6(C)^3}{60n(P)^3} = \frac{10^6}{60 \times 2000} \left(\frac{3210}{529}\right)^3$
= 1862 Hrs