

TIMKEN
Where You Turn

Commercial Vehicle Bearings



2009

⚠ WARNING Failure to observe the following warnings could create a risk of serious injury.

Proper maintenance and handling procedures are critical. Always follow installation instructions and maintain proper lubrication.

Never spin a bearing with compressed air. The rollers may be forcefully expelled.

Note

Timken has taken extreme care in the research and production of this catalog, but cannot under any circumstances be liable for any errors or omissions. Timken reserves the right to modify the contents of this catalog without prior notice. The contents of this catalog are the property of The Timken Company and may not be reproduced, in any form, in whole or in part, without written permission from The Timken Company. Application data may only apply up to the catalog publication date shown on the cover.

⚠ ¡ADVERTENCIA! El incumplimiento de las siguientes normas de seguridad puede originar daños físicos a personas.

Es de vital importancia llevar a cabo unas prácticas adecuadas de mantenimiento y manipulación. No cumplir con las instrucciones de montaje dictadas por el fabricante del vehículo ni realizar una lubricación adecuada de mantenimiento podría provocar fallos en el equipo.

No haga girar nunca un rodamiento con aire comprimido. Los rodillos podrían salir proyectados.

Nota

Timken ha dedicado especial cuidado a la realización de las labores de documentación y elaboración de este catálogo, pero declina cualquier tipo de responsabilidad por errores u omisiones en los que pueda haberse incurrido en la edición del mismo. Timken se reserva el derecho de modificar el contenido de este catálogo sin notificación previa. Este catálogo es propiedad de The Timken Company, no estando autorizada su reproducción, en ningún modo, parcial ni total, si no se cuenta con el permiso escrito de Timken. La información de aplicaciones de productos puede ser válida únicamente hasta la fecha de publicación de este catálogo mostrada en la portada del mismo.

⚠ AVERTISSEMENT! Le non-respect des consignes ci-dessous peut engendrer un risque sérieux de dommages corporels.

Le respect des consignes de montage et de maintenance est essentiel. Le non-respect des instructions de montage fournies par le fabricant du véhicule et une lubrification inappropriée peuvent entraîner un dysfonctionnement de l'appareil.

Ne jamais actionner un roulement avec de l'air comprimé. Les rouleaux peuvent être éjectés violemment.

Note

Timken a apporté toute son attention à l'élaboration et à la production de ce catalogue mais ne peut être tenue pour responsable en cas d'erreur ou d'omission. Timken se réserve le droit de modifier le contenu de ce catalogue sans avertissement préalable. Le contenu de ce catalogue est la propriété de The Timken Company et ne peut être reproduit sous quelque forme que ce soit, dans son intégralité ou partiellement, sans autorisation écrite de The Timken Company. Les informations des différentes applications ne s'appliquent qu'à la date de publication figurant sur la couverture du catalogue.

⚠ ACHTUNG! Missachtung der folgenden Warnhinweise kann schwere körperliche Verletzungen verursachen.

Wartung und Einsatz der Produkte müssen fachgerecht erfolgen. Die Missachtung der Einbauvorschriften des Fahrzeugherstellers und unsachgemäße Schmierung können zu einem Ausfall der Anwendung führen.

Drehen Sie Wälzlager nie mit Druckluft. Die Wälzkörper könnten dabei herausgeschleudert werden.

Anmerkung

Dieser Katalog wurde von Timken mit größter Sorgfalt hergestellt. Die Haftung für etwaige Fehler oder Weglassungen ist ausgeschlossen. Timken behält sich das Recht vor, den Inhalt dieser Druckschrift ohne vorherige Ankündigung zu modifizieren. Der Inhalt dieser Druckschrift ist geistiges Eigentum der Timken Company. Er darf ohne schriftliche Genehmigung in keiner Form, weder als Ganzes noch in Auszügen, reproduziert werden.

⚠ ATTENZIONE! La non osservanza delle seguenti raccomandazioni può creare seri rischi di danni fisici.

L'adozione di procedure corrette di manutenzione e manipolazione è di importanza fondamentale. Il mancato rispetto delle istruzioni di installazione del costruttore del veicolo e una lubrificazione scorretta possono danneggiare l'attrezzatura.

Non utilizzare mai aria compressa per far ruotare un cuscinetto. La forza dell'aria compressa può causare l'espulsione ad alta velocità dei rulli.

Nota

Il presente catalogo è stato redatto a cura di The Timken Company la quale, in nessuna circostanza, potrà essere ritenuta responsabile per eventuali errori o/è omissioni in esso riscontrabili. The Timken Company si riserva il diritto di modificare il contenuto del presente catalogo senza preavviso. Il contenuto di questo documento è di proprietà di The Timken Company e non può essere riprodotto - integralmente o in parte - in nessuna forma senza autorizzazione scritta da parte di The Timken Company. I dati delle applicazioni valgono soltanto fino alla data riportata sulla copertina.

⚠ AVISO! A não observação dos seguintes avisos poderá resultar num risco de danos pessoais graves.

A manutenção e o manuseio apropriados são muito importantes. A não observação das instruções de instalação do fabricante do veículo e a lubrificação inapropriada podem levar a uma avaria do equipamento.

Nunca gire os rolamentos com ar comprimido. Os roletes podem ser projectados a alta velocidade.

Note

A Timken dedicou um especial cuidado à pesquisa e elaboração deste catálogo, mas não pode assumir, em qualquer circunstância, responsabilidade por eventuais erros ou omissões. A Timken reserva-se o direito de alterar o conteúdo deste catálogo sem aviso prévio. Todo o conteúdo deste catálogo é propriedade de The Timken Company e não pode ser reproduzido, em qualquer meio ou forma, no todo ou em parte, sem a permissão escrita de The Timken Company. Os dados relativos às aplicações poderão aplicar-se apenas até à data de publicação do catálogo indicada na capa.

Index

- A. Application listings - Wheel End p. A1**
- Truck p. A3*
 - Trailer p. A189*
 - Bus p. A205*
 - Light Commercial Vehicle . . . p. A241*
- B. Applications listings - Final drive. p. B1**
- C. Product information p. C1**
- Numerical Listings. p. C3*
 - Dimensional Guide p. C15*
 - Cross-Reference Guide. p. C17*
 - Fitting Instructions. p. C27*
 - Bearing Damage Analysis. . . p. C31*
 - Maintenance Tools. p. C35*

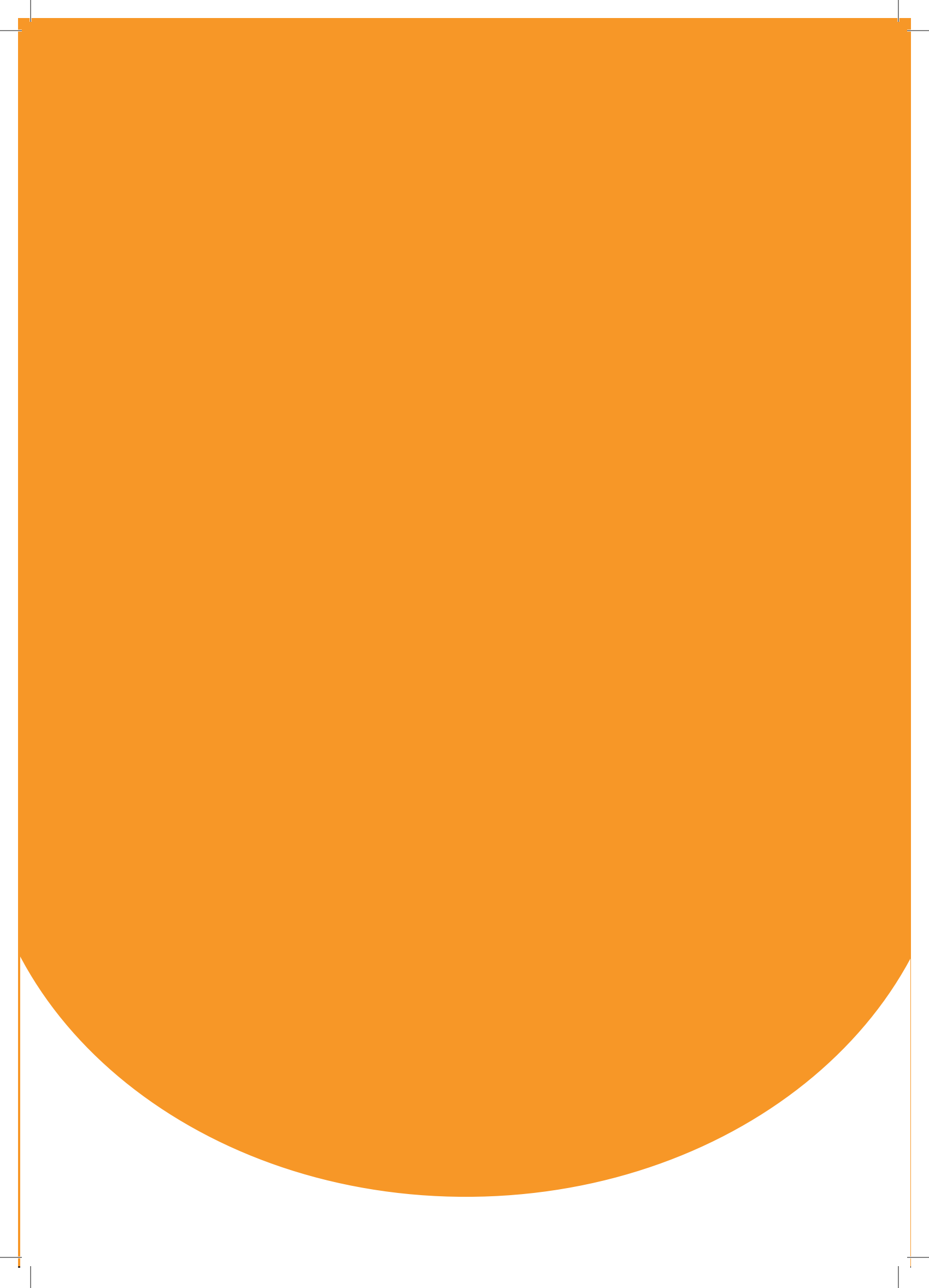

APPLICATION LISTINGS - WHEEL END

A



Application listings - Wheel End

Truck p. A3

Trailer p. A189

Bus p. A205

Light Commercial Vehicle p. A241

APPLICATION LISTINGS - WHEEL END

A

APPLICATION LISTINGS - TRUCK



A

















APPLICATION LISTINGS - TRUCK





APPLICATION LISTINGS - TRUCK













									
AWD									
TL 16									
	EATON 16 SERIES EATON 16 SERIES			580/572 560/552A					
TL 24									
	ROCKWELL 55 MD ROCKWELL 55 MD			598A/592A 580/572					
TL 27									
	ROCKWELL 55 MD ROCKWELL 55 MD			598A/592A 580/572					
BEDFORD									
BFP/BRP/SB/VAM									
	YRQ YRQ		39581/39520 3490/3420						
KC TK 750									
	3-4 T, 6000 LBS 3-4 T, 6000 LBS 3-4 T, 13440 LBS 3-4 T, 13440 LBS		528R/522 2580/2520	482/472 32212					
KC TK 1470									
	9-14 T, 13200 LBS 9-14 T, 13200 LBS 9-14 T, 18200 LBS, 2 SPEED 9-14 T, 18200 LBS, 2 SPEED		H414245X/10 3780/3720	594A/592A 575/572					
KD 750									
	5 T, 6000 LBS 5 T, 6000 LBS 5 T, 13440 LBS 5 T, 13440 LBS		528R/522 2580/2520	482/472 32212					
KD 860									
	11.75 T, 6000 LBS 11.75 T, 6000 LBS 11.75 T, 13440 LBS 11.75 T, 13440 LBS		528R/522 2580/2520	482/472 32212					
KE TK 1000									
	6-8 T, 8200/9600 LBS 6-8 T, 8200/9600 LBS 7-10 T, 8200/9600 LBS		39581/39520 3490/3420 39581/39520						





APPLICATION LISTINGS - TRUCK







     			
BEDFORD			
KE TK 1000 ...			
7-10 T, 8200/9600 LBS 15 T, 8200/9600 LBS 15 T, 8200/9600 LBS 6-8 T, 19040 LBS, 2 SPEED BEDFORD 6-8 T, 19040 LBS, 2 SPEED BEDFORD 6-8 T, 18220 SERIES, 2 SPEED EATON 6-8 T, 18220 SERIES, 2 SPEED EATON 15 T, 17472/19040, SINGLE SPEED 15 T, 17472/19040, SINGLE SPEED 6-8 T, 17472/19040, SINGLE SPEED 6-8 T, 17472/19040, SINGLE SPEED 7-10 T, 17472/19040, SINGLE SPEED 7-10 T, 17472/19040, SINGLE SPEED 7-10 T, 19040 LBS, 2 SPEED BEDFORD 7-10 T, 19040 LBS, 2 SPEED BEDFORD 7-10 T, 18220 SERIES, 2 SPEED EATON 7-10 T, 18220 SERIES, 2 SPEED EATON	33213 39581/39520 3490/3420	575S/572 478XA/473XS 594A/592A 575/572 42686/42624 32212 42686/42624 32212 42686/42624 32212 575S/572 478XA/473XS 594A/592A 575/572	
KF 60 TK 1630/1930			
8200/9600 LBS 8200/9600 LBS 17472/19040 LBS, KGL/KGS 60 17472/19040 LBS, KGL/KGS 60 18220 SERIES, 2 SPEED EATON 18220 SERIES, 2 SPEED EATON 17472/19040, SINGLE SPEED BEDFORD 17472/19040, SINGLE SPEED BEDFORD 19040 LBS, 2 SPEED BEDFORD 19040 LBS, 2 SPEED BEDFORD 22500 SINGLE SPEED BEDFORD 22500 SINGLE SPEED BEDFORD	39581/39520 3490/3420	575S/572 478XA/473XS 594A/592A 478XA/473XS 42686/42624 32212 575S/572 478XA/473XS 32218 32216	
KFA TRACTOR			
16 T, 8200/9600 LBS 16 T, 8200/9600 LBS 16T, 17472/19040 LBS 16T, 17472/19040 LBS	39581/39520 3490/3420	575S/572 478XA/473XS	
KG TK 1260			
7.5-12 T, 8200/9600 LBS 7.5-12 T, 8200/9600 LBS 7.5-12 T, 17472/19040, SINGLE SPEED 7.5-12 T, 17472/19040, SINGLE SPEED 7.5-12 T, 19040 LBS, 2 SPEED 7.5-12 T, 19040 LBS, 2 SPEED 7.5 -12 T, 18220 SERIES, 2 SPEED EATON 7.5 -12 T, 18220 SERIES, 2 SPEED EATON	39581/39520 3490/3420	575S/572 478XA/473XS 575S/572 478XA/473XS 594A/592A 575/572	
KGA TRACTOR			
19 T, 8200/9600 LBS 19 T, 8200/9600 LBS 19 T, 19040 LBS, 2 SPEED BEDFORD 19 T, 19040 LBS, 2 SPEED BEDFORD	39581/39520 3490/3420	575S/572 478XA/473XS	



APPLICATION LISTINGS - TRUCK















									
BEDFORD									
KHA TRACTOR									
	22 T, 13200 LBS 22 T, 13200 LBS 22 T, 22500 LBS 22 T, 22500 LBS	H414245X/10 3780/3720		32218 32216					
KM [6X2]									
	13200 LBS 13200 LBS 22500 LBS 22500 LBS	H414245X/10 3780/3720		32218 32216					
KM [6X4]									
	20 T, 13200 LBS 20 T, 13200 LBS 22 T, 13200 LBS 22 T, 13200 LBS 22 T, 19000 LBS, 38DT, EATON BOGIE 22 T, 19000 LBS, 38DT, EATON BOGIE 20 T, 17000 LBS, 30DT, EATON BOGIE 20 T, 17000 LBS, 30DT, EATON BOGIE	H414245X/10 3780/3720 H414245X/10 3780/3720		594A/592A 575/572 580/572 560/552A					
KM TA 1630									
	22 T, 13200 LBS 22 T, 13200 LBS 10-11 T, 13200 LBS 10-11 T, 13200 LBS 10-11 T, 22500 LBS 10-11 T, 22500 LBS 22 TON 22, 500 LBS 22 TON 22, 500 LBS 10-11 T, 18220 SERIES, 2 SPEED EATON 10-11 T, 18220 SERIES, 2 SPEED EATON 22 T, 18220 SERIES, 2 SPEED EATON 22 T, 18220 SERIES, 2 SPEED EATON	H414245X/10 3780/3720 H414245X/10 3780/3720		32218 32216 32218 32216 594A/592A 575/572 594A/592A 575/572					
KM TRACTOR									
	32 T, 13200 LBS 32 T, 13200 LBS 32 T, 22500 LBS 32 T, 22500 LBS	H414245X/10 3780/3720		32218 32216					
TL 570/750/860									
	6000 LBS 6000 LBS 13440 LBS 13440 LBS 13440 LBS 13440 LBS	528R/522 2580/2520		482A/472 3977X/3921XA 482A/472				- 07/1982 - 07/1982 07/1982 - 07/1982 -	
TL 1000/1260									
	8200/9600 LBS 8200/9600 LBS	39581/39520 3490/3420							



APPLICATION LISTINGS - TRUCK

A

















     					
BEDFORD					
TL 1470					
	13200 LBS 13200 LBS 18220 SERIES, 2 SPEED EATON 18220 SERIES, 2 SPEED EATON	H414245X/10 3780/3720	594A/592A 575/572		
TL 1500					
	18220 SERIES, 2 SPEED EATON		594A/592A		
TL 1630					
	13200 LBS 13200 LBS 17472/19040 LBS, SINGLE SPEED 17472/19040 LBS, SINGLE SPEED 17472/19040 LBS, SINGLE SPEED 19040 LBS, 2 SPEED 19040 LBS, 2 SPEED 19040 LBS, 2 SPEED 18220 SERIES, 2 SPEED EATON 18220 SERIES, 2 SPEED EATON	H414245X/10 3780/3720	32212 42686/42624 32212 575S/572 478XA/473XS 478XA/473XS 594A/592A 575/572		07/82 - -07/82 -07/82 -07/82 -07/82 07/82 -
TL 1650					
	18220 SERIES, 2 SPEED EATON 17472/19040LBS, SINGLE SPEED		575/572 478XA/473XS		-07/82
TL 1930					
	8200/9600 LBS 8200/9600 LBS 17472/19040LBS, SINGLE SPEED 18220 SERIES, 2 SPEED EATON 18220 SERIES, 2 SPEED EATON	39581/39520 3490/3420	32212 594A/592A 575/572		07/82 -
TM 1700					
	13200 LBS, RIGID, BEDFORD 500 ENGINE 13200 LBS, RIGID, BEDFORD 500 ENGINE 13200 LBS, RIGID, DETROIT ENGINE 13200 LBS, RIGID, DETROIT ENGINE 19128 LBS, SINGLE SPEED, SPIRAL BEVEL 19128 LBS, SINGLE SPEED, SPIRAL BEVEL 22500 LBS, RIGID, BEDFORD 500 ENGINE 22500 LBS, RIGID, BEDFORD 500 ENGINE	H414245X/10 3780/3720 H414245X/10 3780/3720	594A/592A 575/572 32218 32216		
TM 2250 [6X4]					
	13200 LBS 13200 LBS DS380 & DSP380, BOGIE EATON DS380 & DSP380, BOGIE EATON	H414245X/10 3780/3720	594A/592A 575/572		



APPLICATION LISTINGS - TRUCK

























































				 			
BEDFORD							
TM 2250/2300/2500/2600/3250 TRACTOR							
	13200 LBS 13200 LBS 19128 LBS, SINGLE SPEED, SPIRAL BEVEL 19128 LBS, SINGLE SPEED, SPIRAL BEVEL 18300 LBS, DOUBLE RED. SPIRAL BEVEL 18300 LBS, DOUBLE RED. SPIRAL BEVEL	H414245X/10 3780/3720		594A/592A 575/572 594A/592A 575/572			
TM 3800 TRACTOR							
	13200 LBS 13200 LBS SOMA SOMA ROCKWELL ROCKWELL	H414245X/10 3780/3720		33019 32017X 594A/592A 580/572X			
YRT SERIES							
		H414245X/10 3780/3720		32218 32216			
BRISTOL							
LH SERIES							
		623/612 3490/3420		580/572X 566/563			
NATIONAL CHASSIS							
		H212749/10 JM205149/10		683/672 683/672			
RE SERIES							
		558/552A 49175/49368		HM218248/10 HM218248/10			
TLH/TLL/TSH/VR							
		H414245X/10 3780/3720		HM218248/10 HM218248/10			



APPLICATION LISTINGS - TRUCK



















 		 			
DAF					
CF 65					
	150N/152N 150N/152N 172N 182N 182N SR1132 SR1132 SR1347 SR1347 AAS1354/AAS1355 TRAILING AXLE TRAILING AXLE	EK50022 32310 32311 EK50022 32310	EK50020 33019 EK50020 33019 EK50021 681A/672 663/653	 Seal, no integration  Seal, no integration  Seal, no integration  Seal, no integration  Seal, no integration  Seal, no integration  Seal, no integration  Seal, no integration	 
CF 75					
	150N 150N 152N 152N 172N SR1132 SR1132 SR1339 SR1339 AAS1354 AAS1355 HR1346 HR1346 TRAILING AXLE TRAILING AXLE	EK50022 32310 EK50022 32310 32311	EK50020 33019 EK50020 33019 EK50021 EK50021 EK50020 33019 681A/672 663/653	 Seal, no integration  Seal, no integration  Seal, no integration  Seal, no integration  Seal, no integration  Seal, no integration  Seal, no integration  Seal, no integration  Seal, no integration  Seal, no integration  Seal, no integration	   
CF 85					
	152N 152N 172N 182N 182N SR1347 SR1347 AAS1354 HR1355 TRAILING AXLE TRAILING AXLE	EK50022 32310 32311 EK50022 32310	EK50020 33019 EK50021 EK50021 681A/672 663/653	 Seal, no integration  Seal, no integration  Seal, no integration  Seal, no integration  Seal, no integration  Seal, no integration  Seal, no integration  Seal, no integration  Seal, no integration	   
F95 SERIES					
	152N 152N 172N HR1346 HR1346 AAS1354 AAS1355 TRAILING AXLE TRAILING AXLE	EK50022 32310 32311	EK50020 33019 EK50021 EK50021 681A/672 663/653	 Seal, no integration  Seal, no integration  Seal, no integration  Seal, no integration  Seal, no integration  Seal, no integration  Seal, no integration  Seal, no integration	 



APPLICATION LISTINGS - TRUCK



							
DAF							
F600/F800 SERIES							
	60 N 60 N 512 512	33209 32206		395S/394A 395S/394A			
F1000 SERIES							
	84N 84N 715 715	45291/45220 3490/3420		JM714249/10 JM511946/10			
F1600 SERIES							
	N94 N94 N100 N100 N142 N142 1635 1635 1635 1635	39581/39520 3585/3525 5583/5535 3782/3720 EK50001 32310		681A/672 47687/47620 598A/592A 47687/47620			Track width 1718mm with 10 bolt  Track width 1718mm with 10 bolt  Track width 1655mm with 8 bolt  Track width 1655mm with 8 bolt 
F1700 SERIES							
	122N	32309					
F1800 SERIES							
	1628V 1628V 2255 2255	594A/592XS 27687/27620		681A/672 663/653			
F1900 SERIES							
	122N 131N	32309B 32309B					
F2000/F2005 SERIES							
	N100 N100 N122 N122 N142 N142 N142 N142 1635 1635 2255 2255 TRAILING AXLE TRAILING AXLE	5583/5535 3782/3720 6379/6321 3782/3720 EK50001 32310 EK50001 33210		681A/672 47687/47620 681A/672 663/653 681A/672 663/653			1 1 2 2

APPLICATION LISTINGS - TRUCK















A



DAF									
F2100/F2105 SERIES									
	N100	5583/5535							
	N100	3782/3720							
	N142	EK50001						2	
	N142	33210						2	
	N142	EK50001						1	11
	N142	32310						1	11
	N142	EK50001						1	12
	N142	32310						1	12
	2255			681A/672					
	2255			663/653					
	2699			687/672					
	2699			48393/48320					
	TRAILING AXLE			681A/672					
	TRAILING AXLE			663/653					
F2200/F2205 SERIES									
	N122	6379/6321							
	N122	3782/3720							
	N142	32310						1	12
	N142	32310						1	11
	2255			681A/672					
	2255			663/653					
	2676			683/672					
	2676			749A/742					
	2699			687/672					
	2699			48393/48320					
	TRAILING AXLE			681A/672					
	TRAILING AXLE			663/653					
F2300/F2305 SERIES									
	N142	EK50001						2	
	N142	33210						2	
	N142	EK50001						1	11
	N142	32310						1	11
	N142	EK50001						1	12
	N142	32310						1	12
	2255			681A/672					
	2255			663/653					
	2699			687/672				3	
	2699			48393/48320				3	
	TRAILING AXLE			681A/672					
	TRAILING AXLE			663/653					
F2500/F2503/F2505 SERIES									
	N142	EK50001							
	N142	32310							
	2255			681A/672					Exc. FAR
	2255			663/653					Exc. FAR
	2255			681A/672					FAR
	2255			663/653					FAR
	2699			EK50021					Exc. FA & FT
	2699			687/672					FA & FT

APPLICATION LISTINGS - TRUCK



							
DAF							
F2500/F2503/F2505 SERIES ...							
	2699 TRAILING AXLE TRAILING AXLE			48393/48320 681A/672 663/653			FA & FT
F2700 SERIES							
	N142 N142 1346 1346	EK50001 32310		EK50020 33019			
F2800 SERIES							
	140N 140N 140N 140N N140 N140 N140 N140 N140 142N 142N 142N 142N 2255 2255 2699 2699 TRAILING AXLE TRAILING AXLE	EK50001 33210 EK50001 33210 EK50001 32310 EK50001 32310 EK50001 32310 EK50001 32310 EK50001 32310		681A/672 663/653 687/672 48393/48320 681A/672 663/653			
F2900 SERIES							
	142N 142N 142N 142N 1346 1346 1354 1355	EK50001 32310 EK50001 32310		EK50020 33019 EK50021 EK50021			
F3200 SERIES							
	142N 142N 1354 TRAILING AXLE TRAILING AXLE	EK50001 32310		EK50021 681A/672 663/653			
F3300/3305 SERIES							
	N142 N142 2699 2699 TRAILING AXLE TRAILING AXLE	EK50001 32310		687/672 48393/48320 681A/672 663/653			



APPLICATION LISTINGS - TRUCK

















DAF									
F3600 SERIES									
	N142 N142 1346 1346 1355 2699	EK50001 32310		EK50020 33019 EK50021 EK50021					
LF 45									
	F36 F36 F48 F48 SR5.14 SR5.14	JM20749A 32206M 39581 32206M		32016X 3984/3920					
LF 55									
	F60 F60 152N 152N SR10.20 SR10.20 SR1132 SR1132	H212749/10 33209 EK50022 32310		32019X 495/493 EK50020 33019					
N2800 SERIES									
	142N 142N 142N 142N 2699 2699	EK50001 32310 EK50001 32310		687/672 48393/48320					
VARIOUS									
	DANA S 130			NP793154-90UA2					
XF 95									
	150N 150N 152N 152N 172N SR1347 SR1347 AAS1354 AAS1355 TRAILING AXLE TRAILING AXLE	EK50022 32310 EK50022 32310 32311		EK50020 33019 EK50021 EK50021 681A/672 663/653					





APPLICATION LISTINGS - TRUCK









					
DAF					
XF 95.530					
	182N 182N SR1347 SR1347 AAS1354 AAS1355 TRAILING AXLE TRAILING AXLE	EK50022 32310	EK50020 33019 EK50021 EK50021 681A/672 663/653		ABS/Seal, no integration ABS/Seal, no integration ABS/Seal, no integration ABS/Seal, no integration ABS/Seal, no integration ABS/Seal, no integration
DODGE					
50 SERIES RB S35					
	AX 1 AX 6 AX 6		397XA/394XS 3984/3920 32012X		
50 SERIES RB S38/S56					
		2788/2720 30305			
50 SERIES RB S46					
	AX 6 AX 6 AX 8	2788/2720 30305	3984/3920 32012X 30213		
50 SERIES RB S66					
	AX 9 AX 9	2788/2720 30305	567X/563 3984/3920		
50 SERIES RB S75					
	AX 9 AX 9	25580/25520 1988/1922	567X/563 3984/3920		
100 SERIES G08/09/10					
	3.5T 3.5T 4X4 4X4 EATON 16000, 2 SPEED EATON 16000, 2 SPEED	25877/25820 3778/3720	578X/572 3984/3920 578X/572 3984/3920		
100 SERIES G15					
	14.5T, KIRKSTALL 14.5T, KIRKSTALL 14.5T, ALFORD & ALDER 5.2 14.5T, ALFORD & ALDER 5.2 EATON 18000, 1 & 2 SPEED	H414242/10 527/522 HM212047/11 3585/3525	594A/592A		









APPLICATION LISTINGS - TRUCK



     	
DODGE	
100 SERIES G15 ...	
EATON 18000, 1 & 2 SPEED	HM515745/16
100 SERIES G16	
16T, KIRKSTALL 16T, KIRKSTALL 16T, ALFORD & ALDER 6.5 16T, ALFORD & ALDER 6.5 16 T, EATON 18000 16 T, EATON 18000	H414242/10 527/522 H414242/10 527/522 594A/592A HM515745/1616
100 SERIES G18	
3.5 T 3.5 T EATON 16000, 2 SPEED EATON 16000, 2 SPEED DODGE AX4 DODGE AX4	3778/3720 25877/25820 578X/572 3984/3920 578X/572 3984/3920
100 SERIES G20	
EATON 16000, 2 SPEED EATON 16000, 2 SPEED AX4 AX4 EATON 18000 EATON 18000	39581/39520 3490/3420 578X/572 3984/3920 578X/572 3984/3920 594A/592A HM515745/16
100 SERIES G24	
KIRKSTALL KIRKSTALL	H414242/10 527/522
100 SERIES G26	
16T, ALFORD & ALDER 6.5 16T, ALFORD & ALDER 6.5 EATON 18000 EATON 18000	H414242/10 527/522 594A/592A HM515745/16
300 SERIES K 3820 P TRACTOR	
8T 8T 232 N 232 N	HM212749/10 3780/3720 HM220149/10 HM218248/10
ERF	
B SERIES [DRAWBAR]	
KIRKSTALL, 14000 LBS KIRKSTALL, 14000 LBS KIRKSTALL D85-10.2 KIRKSTALL D85-10.2	H212749/10 HM204049/10 56426/56650 594A/592A



APPLICATION LISTINGS - TRUCK







									
ERF									
35/38 C2, 35/38 R2									
	KIRKSTALL, 14000 LBS KIRKSTALL, 14000 LBS KIRKSTALL D85-10.2 KIRKSTALL D85-10.2	H212749/10 HM204049/10		56426/56650 594A/592A					
VARIOUS TRUCKS									
	KIRKSTALL S62/S63 KIRKSTALL S62/S63 KIRKSTALL S60 KIRKSTALL S60 ROCKWELL ROCKWELL KIRKSTALL D85 ROCKWELL R170/R180 ROCKWELL R170/R180 GKN D85 10.2 KIRKSTALL D85 KIRKSTALL D85	H212749/10 HM204049/10 6379/6320 615/612 H414249/10 527/522		52401/52618 594A/592A 580/572X 594A/592A 56426/56650 594A/592A					
FODEN									
200 SERIES									
	GKN S63 GKN S63 24T, G.V.W 24T, G.V.W	H212749/10 HM204049/10 HM215249/10 JM205149/10							
FLEETMASTER TRACTOR UNIT									
	FODEN 6.5T FODEN 6.5T ROCKWELL 11.3T ROCKWELL 11.3T	HM215249/10 JM205149/10		HM215249/10 580/572					
HAULMASTER [6X4]									
	FODEN 6.5T FODEN 6.5T 10T 10T ROCKWELL SRQHD BOGIE ROCKWELL SRQHD BOGIE	HM215249/10 JM205149/10		663/653 52400/52618 598A/592A 580/572				10	10
HAULMASTER [8X4]									
	FODEN 6.5T FODEN 6.5T 10T 10T	HM215249/10 JM205149/10		663/653 52400/52618				10	10
RIGID [6X4]									
	24T, G.V.W 24T, G.V.W 24T, G.V.W, HIGH SPEED HUB RED. 24T, G.V.W, HIGH SPEED HUB RED. 24T, G.V.W-10T, SINGLE RED.	HM215249/10 JM205149/10		74550/74850 52400/52618 663/653					





APPLICATION LISTINGS - TRUCK



     					
FODEN					
RIGID [6X4] ...					
	24T, G.V.W-10T, SINGLE RED.		52400/52618	0	
RIGID MIXER [6X4]					
	24T, G.V.W	HM215249/10		1	
	24T, G.V.W	JM205149/10		0	
	24T, G.V.W-EATON		594A/592A	1	
	24T, G.V.W-EATON		575/572	0	
RIGID TIPPER [8X4]					
	30T, G.V.W	HM215249/10		1	
	30T, G.V.W	JM205149/10		0	
	30T, G.V.W, HIGH SPEED HUB RED.		74550/74850	1	
	30T, G.V.W, HIGH SPEED HUB RED.		52400/52618	0	
	30T, G.V.W, 10T, SINGLE RED.		663/653	1	
	30T, G.V.W, 10T, SINGLE RED.		52400/52618	0	
S 10					
	FODEN 6.5T	HM215249/10		1	
	FODEN 6.5T	JM205149/10		0	
	10T		663/653	1	10
	10T		52400/52618	0	10
SIXER					
	FODEN 6.5T	HM215249/10		1	
	FODEN 6.5T	JM205149/10		0	
	EATON D58 7380		594A/592A	1	
	EATON D58 7380		575/572	0	
TIPPER [8X4]					
	32T, G.V.W-FODEN 6.5T	HM215249/10		1	
	32T, G.V.W-FODEN 6.5T	JM205149/10		0	
	32T, G.V.W		74550/74850	1	
	32T, G.V.W		52400/52618	0	
TRACTOR UNIT [4X2]					
	26T, G.V.W	HM215249/10		1	
	26T, G.V.W	JM205149/10		0	
	26T, G.V.W, FODEN 10T, SINGLE RED.		663/653	1	
	26T, G.V.W, FODEN 10T, SINGLE RED.		52400/52618	0	
UNIVERSAL 38 T					
	FODEN 6.5T	HM215249/10		1	
	FODEN 6.5T	JM205149/10		0	
	EATON D58 7380		594A/592A	1	
	EATON D58 7380		575/572	0	
	KIRKSTALL S 62		HM212044/11	1	
	KIRKSTALL S 62		HM204049/10	0	





APPLICATION LISTINGS - TRUCK



HINO							
FS 271 KD							
		32313					
		32310					
FS 275							
		32313					
		32310		32218			
				32217			
SH 283 KA							
		32313					
		32310					
IVECO							
50-9							
	IVECO 5822	30309					-12/86
	IVECO 5822	30307					-12/86
	IVECO 4516HD			32014X			01/87 -
	IVECO 4516HD			32014X			01/87 -
	IVECO 4419 [N050-9 D/V]			33113			
	IVECO 4419 [N050-9 D/V]			33113			
55-8/9/10 [I SERIES]							
	IVECO 5822/IVECO 5830	30309					
	IVECO 5822/IVECO 5830	30307					
	IVECO 4516			33113			
	IVECO 4516			33113			
A 55-10/60-10/A 60-10 [I-II SERIES]							
	IVECO 5822/IVECO 5830	30309					
	IVECO 5822/IVECO 5830	30307					
	IVECO 4516			33113			
	IVECO 4516			33113			
60-8 [III SERIES]							
	IVECO 5822/IVECO 5830	30309					
	IVECO 5822/IVECO 5830	30307					
	IVECO 4516			33113			
	IVECO 4516			33113			
65-9/EXPORT CKD, 65-12/D/H/V							
	IVECO 5827	JXC18439CA/DA					
	IVECO 5827	JXC25370CA/DA					
	IVECO 5830	30309					
	IVECO 5830	30307					
	IVECO 4519			33113			
	IVECO 4519			33113			
	IVECO 4517			XC2379CD/DA			
	IVECO 4517			XC2379CD/DA			





APPLICATION LISTINGS - TRUCK



IVECO							
70-10 [I SERIES]							
	IVECO 5830	30309			33113		
	IVECO 5830	30307			33113		
	IVECO 4519						
	IVECO 4519						
A 70-12 [I-II SERIES] / A 70-14							
	IVECO 5830	30309					
	IVECO 5830	30307					
	IVECO 4519				33113		
	IVECO 4519				33113		
75-13/16 AW							
	IVECO 5918 [AVA 36]	32017X					
	IVECO 5918 [AVA 36]	47487/47420					
	IVECO 7899 [HA 72]				32017X		
	IVECO 7899 [HA 72]				47487/47420		
75-13 WM [4X4] / 75-14 WM							
	IVECO 5918 [AVA 36]	32017X					
	IVECO 5918 [AVA 36]	47487/47420					
	IVECO 4518				32017X		
	IVECO 4518				47487/47420		
79-11 / 79-12 D							
	IVECO 5830	30309					
	IVECO 5830	30307					
	IVECO 4519				33113		
	IVECO 4519				33113		
79-12 V/CKD, 79-14/D/V							
	IVECO 5830	30309					
	IVECO 5830	30307					
	IVECO 4519				33113		
	IVECO 4519				33113		
80-13 [I SERIES]							
	IVECO 5830	30309					
	IVECO 5830	30307					
	IVECO 5822	30309					
	IVECO 5822	30307					
80-13 A/AH/AT, 80-16 A							
	IVECO 582201	30309					01/85 -
	IVECO 582201	30307					01/85 -
	IVECO 5830	30309					
	IVECO 5830	30307					
	ROCKWELL 125E01				567/563		01/85 -
	ROCKWELL 125E01				3984/3920		01/85 -
80-13 AW / 80-16 AW [4X4]							
	IVECO 5918 [AVA 36]	XAA33212/Y33212					
	IVECO 5918 [AVA 36]	33209					
	IVECO 7899 [HA 72]				32017X		

















APPLICATION LISTINGS - TRUCK

					
IVECO					
80-13 AW / 80-16 AW [4X4] ...					
	IVECO 7899 [HA 72]		47487/47420		
80-14/17 W					
	IVECO 5918 [AVA 36] IVECO 5918 [AVA 36] IVECO 4518 IVECO 4518	32017X 47487/47420	32017X 47487/47420		
90-13/A90-13 [I-II SERIES]					
	IVECO 5830 IVECO 5830 IVECO 5822 IVECO 5822	30309 30307 30309 30307			
90-13 A/AH, A90-14 [III-IV SERIES]					
	IVECO 5830 IVECO 5830 IVECO 5822 IVECO 5822 ROCKWELL [125E] ROCKWELL [125E]	30309 30307 30309 30307	567/563 3984/3920		
90-14 WM [4X4] / 90-17 WM					
	IVECO 5918 [AVA 36] IVECO 5918 [AVA 36] IVECO 4518 IVECO 4518	32017X 47487/47420	32017X 47487/47420		
90-16 AW					
	IVECO 5918 [AVA 36] IVECO 5918 [AVA 36] IVECO 7899 [HA 72] IVECO 7899 [HA 72]	32017X 47487/47420	32017X 47487/47420		
95-14 [III-IV SERIES]					
	IVECO 5830 IVECO 5830 IVECO 5822 IVECO 5822 ROCKWELL [125E] ROCKWELL [125E]	30309 30307 30309 30307	567/563 3984/3920		- 01/85 - 01/85 - 01/85 - 01/85
100 E15/E18					
	IVECO 5833 IVECO 5833 IVECO 4517 IVECO 4517 IVECO 4521 IVECO 4521 ROCKWELL [F120-F125] ROCKWELL [F120-F125]	JXC18439CA/DA JXC25370CA/DA	XC2379CD/DA XC2379CD/DA JXC25716C/D JXC25716C/D 567/563 3984/3920		

















APPLICATION LISTINGS - TRUCK



							
IVECO							
100 E17							
	IVECO 5833 IVECO 5833 IVECO 4521 IVECO 4521	JXC18439CA/DA JXC25370CA/DA		JXC25716C/D JXC25716C/D			
109-14/CKD							
	IVECO 5830 ROCKWELL [H140E] ROCKWELL [H140E]	33207 30309 30307		XAA32217/Y32217 JM714249/10			12/85 - 12/85 -
110-16 A/AH							
	IVECO [VA43] IVECO [VA43] IVECO 4540 IVECO 4540	32211 32208		30216 32215			
115-14/17/17 H [I-II SERIES]							
	IVECO 5844M IVECO 5844M ROCKWELL [H125-P130] ROCKWELL [H125-P130]	33212 33211		XAA32217/Y32217 JM714249/10			
115-17 [II SERIES]							
	ROCKWELL [H140E] ROCKWELL [H140E]			XAA32217/Y32217 JM714249/10			
120-13/14 [II SERIES]							
	IVECO 5850 IVECO 5850 IVECO 4528/2	32312 30311		32217			
120-17 ANW							
		30216 30215		30221 30218			
120 E15/E15 H/E18/E18 H							
	IVECO 5842/5851 IVECO 5842/5851 ROCKWELL [H125-P130] ROCKWELL [H125-P130]	JXC25389CC/DA JXC25389CC/DA		XAA32217/Y32217 JM714249/10			
120 E21 H							
				XAA32217/Y32217 JM714249/10			
130-13 A/AH, 130-16 A/AH							
	IVECO [VA43] IVECO [VA43] IVECO 4540 IVECO 4540	32211 32208		30216 32215			

APPLICATION LISTINGS - TRUCK



									
IVECO									
130 E28 TECTOR									
			JXC25389CC/9DA JXC25389CC/9DA		XAA32217/Y32217 JM714249/10				
130-M7 FAL CKD									
	IVECO 5918 [AVA36] IVECO 5918 [AVA36] IVECO 7899 [HA72] IVECO 7899 [HA72]		47487/47420 32017X		47487/47420 32017X				
A135-14 [5000]/CKD									
	IVECO 5844M IVECO 5844M ROCKWELL [H140E] ROCKWELL [H140E]		33212 33211		XAA32217/Y32217 JM714249/10			12/85 - 12/85 - 12/85 - 12/85 -	
A135-17 [5000]/[4400] CKD									
	IVECO 5844M IVECO 5844M ROCKWELL [H140E] ROCKWELL [H140E]		33212 33211		XAA32217/Y32217 JM714249/10			12/85 - 12/85 - 12/85 - 12/85 -	
135-14 H/HCKD, 135-14 [H]									
	IVECO 5844M IVECO 5844M ROCKWELL [H140E] ROCKWELL [H140E]		33212 33211		XAA32217/Y32217 JM714249/10			12/85 - 12/85 - 12/85 - 12/85 -	
135-14 [H] / CKD									
	IVECO 5844M IVECO 5844M ROCKWELL [H140E] ROCKWELL [H140E]		33212 33211		XAA32217/Y32217 JM714249/10			12/85 - 12/85 - 12/85 - 12/85 -	
135-17 [H], 135-17 H/HCKD									
	IVECO 5844M IVECO 5844M ROCKWELL [H140E] ROCKWELL [H140E]		33212 33211		XAA32217/Y32217 JM714249/10			12/85 - 12/85 - 12/85 - 12/85 -	
135-17 [HO CKD] / 135-17 T									
	IVECO 5844M IVECO 5844M ROCKWELL [H140E] ROCKWELL [H140E]		33212 33211		XAA32217/Y32217 JM714249/10			12/85 - 12/85 - 12/85 - 12/85 -	
135-17 [I SERIES]/[II SERIES]									
	IVECO 5844M IVECO 5844M ROCKWELL [H140E] ROCKWELL [H140E]		33212 33211		XAA32217/Y32217 JM714249/10				



APPLICATION LISTINGS - TRUCK

A



IVECO							
A135-17 [II SERIES]							
	IVECO 5844M IVECO 5844M ROCKWELL [H140E] ROCKWELL [H140E]	33212 33211		XAA32217/Y32217 JM714249/10			
140-14 [II SERIES] / 140-20 [II SERIES]							
	IVECO 5850 IVECO 5850 IVECO 4542 IVECO 4542	32312 30311		32219 32217			
145-17 [II SERIES]							
	IVECO 5844M IVECO 5844M ROCKWELL [S180E] ROCKWELL [S180E]	33212 33211		XAA32219/Y32219 XAA32217/Y32217			
150-14 [II SERIES] / 150-16 A [II SERIES]							
	IVECO 5850 IVECO 5850 IVECO 4542 IVECO 4542	32312 30311		32219 32217			
150-17 [I SERIES][II SERIES]							
	IVECO 5850 IVECO 5850 IVECO 4542 IVECO 4542	32312 30311		32219 32217			
150 E18 TECTOR							
				XAA32219/Y32219 XAA32217/Y32217			
159-17/20 [I SERIES], 159-17B/16A [II SERIES]							
	IVECO 5860 IVECO 5860 IVECO 4542 IVECO 4542	6386/6320 32310		32219 32217			
160-23 AH							
	IVECO 5875 IVECO 5875 IVECO 4590 IVECO 4590	JH415647/10 32311		32024X 30221			
160-23 AHW/ANW [4X4]							
	IVECO 5965/5975 IVECO 5965/5975 IVECO 4590 IVECO 4590	32021X 33019		32024X 30221			





APPLICATION LISTINGS - TRUCK





IVECO											
160-26											
	IVECO 5865 IVECO 5865 IVECO 4560 IVECO 4560	6386/6320 32310		32221 6581X/6535							
160-30 AHW											
	IVECO 5965/5975 IVECO 5965/5975 IVECO 4590 IVECO 4590	32021X 33019		32024X 30221							
165-24 [II SERIES]											
	IVECO 5860 IVECO 5860 IVECO 4542 IVECO 4542	6386/6320 32310		32219 32217							
170/190-20/26/35											
	IVECO 5865 IVECO 5865 IVECO 4590 IVECO 4590	6386/6320 32310		32024X 30221							
170-23/25/34 AH/AHW											
		JH415647/10 32311 32021X 33019		32024X 30221		RWD RWD FWD FWD					
175-17/24/24T, 175-24 NETT./URB											
	IVECO 5860 IVECO 5860 IVECO 5865 IVECO 5865 ROCKWELL [R130-S180] ROCKWELL [R130-S180] ROCKWELL [S160E] ROCKWELL [S160E]	6386/6320 32310 6386/6320 32310		XAA32219/Y32219 XAA32217/Y32217 XAA32219/Y32219 XAA32217/Y32217							
175-24 CKD, A 175-24											
	IVECO 5860 IVECO 5860 IVECO 5865 IVECO 5865 ROCKWELL [R130-S180] ROCKWELL [R130-S180] ROCKWELL [S160E] ROCKWELL [S160E]	6386/6320 32310 6386/6320 32310		XAA32219/Y32219 XAA32217/Y32217 XAA32219/Y32219 XAA32217/Y32217							



















APPLICATION LISTINGS - TRUCK



     	
IVECO	
190-25 AN/ANT/ANCKD	
IVECO 5875 IVECO 5875 IVECO 4590 IVECO 4590	JH415647/10 32311 32024X 30221
190-25 AN [TAM]/AHT/[256M19]	
IVECO 5875 IVECO 5875 IVECO 4590 IVECO 4590	JH415647/10 32311 32024X 30221
190-25 ANW [4X4]	
IVECO 5975/5965 IVECO 5975/5965 IVECO 4590 IVECO 4590	32021X 33019 32024X 30221
190-26 H/HT/HCKD	
IVECO 5875 IVECO 5875 IVECO 4590 IVECO 4590	JH415647/10 32311 32024X 30221
190-26 N [CB5] NT [CB5] / 190-26 N CKD	
IVECO 5875 IVECO 5875 IVECO 4590 IVECO 4590	JH415647/10 32311 32024X 30221
190-26 HW [4X4]	
IVECO 5975/5965 IVECO 5975/5965 IVECO 4590 IVECO 4590	32021X 33019 32024X 30221
190-29 290 M19	
IVECO 5875 IVECO 5875 IVECO 4590 IVECO 4590	JH415647/10 32311 32024X 30221
190-30	
IVECO 5875 IVECO 5875 ROCKWELL U SERIES ROCKWELL U SERIES	JH415647/10 32311 32221 XAA32217/Y32217
190-30 G.V.-06/88, 190-30 TRU-01/85	
IVECO 5875 IVECO 5875 ROCKWELL [U180E] ROCKWELL [U180E]	JH415647/10 32311 32221 XAA32217/Y32217



APPLICATION LISTINGS - TRUCK















					
IVECO					
190-30 H CKD					
	IVECO 5830 IVECO 5830 IVECO 4519 IVECO 4519	30309 30307	33113 33113		
190-30 HW					
	IVECO 5965/5975 IVECO 5965/5975 IVECO 4590 IVECO 4590	33019 32021X	32024X 30221		
190-30 PT. RANGE/PT GR. VOL./PT T. RANGE					
	IVECO 5875 IVECO 5875 ROCKWELL [U180E] ROCKWELL [U180E]	JH415647/10 32311	32221 XAA32217/Y32217		
190-30 T EKO [T-UN]/T T. RANGE/PT GR. VOL.T					
	IVECO 5875 IVECO 5875 ROCKWELL [U180E] ROCKWELL [U180E]	JH415647/10 32311	32221 XAA32217/Y32217		
190-30 N/NT					
	IVECO 5875 IVECO 5875 IVECO 4590 IVECO 4590	JH415647/10 32311	32024X 30221		
190-32 320 M19					
	IVECO 5875 IVECO 5875 IVECO 4590 IVECO 4590	JH415647/10 32311	32024X 30221		
190-32 P/PT GR. VOL.					
	IVECO 5875 IVECO 5875 ROCKWELL [U180E] ROCKWELL [U180E]	JH415647/10 32311	32221 XAA32217/Y32217		
190-35					
	IVECO 5865 IVECO 5865 IVECO 4560 IVECO 4560	6386/6320 32310	32221 6581X/6535		
190-36 360 M19					
	IVECO 5875 IVECO 5875 IVECO 4590 IVECO 4590	JH415647/10 32311	32024X 30221		



APPLICATION LISTINGS - TRUCK















A



 		 			
IVECO					
190-36 PT. RANGE/PT T.RANGE/T. RANGE					
	IVECO 5875 IVECO 5875 ROCKWELL [U180E] ROCKWELL [U180E]	JH415647/10 32311	32221 XAA32217/Y32217		
190-36 PT/P/T/TT TURBOSTAR					
	IVECO 5875 IVECO 5875 ROCKWELL [U180E] ROCKWELL [U180E]	JH415647/10 32311	32221 XAA32217/Y32217		
190-38 /[T-UN]/T [T-UN]/T.R.U.					
	IVECO 5875 IVECO 5875 ROCKWELL [U180E] ROCKWELL [U180E]	JH415647/10 32311	32221 XAA32217/Y32217		
190-42/PH/T					
	IVECO 5875 IVECO 5875 ROCKWELL [U180E] ROCKWELL [U180E]	JH415647/10 32311	32221 XAA32217/Y32217		
220-30 PT [6X2] T-UN/T.R.U. [- 01/85]					
	IVECO 5875 IVECO 5875 ROCKWELL [U180E] ROCKWELL [U180E]	JH415647/10 32311	32221 XAA32217/Y32217		
220-32 AHT					
	IVECO 5875 IVECO 5875 IVECO 4590 IVECO 4590	JH415647/10 32311	32024X 30221		
230-35 WM [6X6]					
	IVECO 5965/5975 IVECO 5965/5975 IVECO 4590 IVECO 4590	32021X 33019	32024X 30221		
220-36 [- 04/87], 220-36 P/PT [6X2] T RANGE					
	IVECO 5875 IVECO 5875 ROCKWELL [U180E] ROCKWELL [U180E]	JH415647/10 32311	32221 XAA32217/Y32217		
220-36 360 M22, 220-38					
	IVECO 5875 IVECO 5875 IVECO 4590 IVECO 4590	JH415647/10 32311	32024X 30221		

APPLICATION LISTINGS - TRUCK



					
IVECO					
220-38 T.R.U. [- 01/85]					
	IVECO 5875 IVECO 5875 ROCKWELL [U180E] ROCKWELL [U180E]	JH415647/10 32311	32221 XAA32217/Y32217		
240-26/T.R.U. [- 06/88]					
	IVECO 5875 IVECO 5875 ROCKWELL [U180E] ROCKWELL [U180E]	JH415647/10 32311	32221 XAA32217/Y32217		
240-30 [- 01/85] / T.R.U. [- 01/85], 240-30 P [6X2] T-UN					
	IVECO 5875 IVECO 5875 ROCKWELL [U180E] ROCKWELL [U180E]	JH415647/10 32311	32221 XAA32217/Y32217		
240-30					
	IVECO 5875 IVECO 5875 IVECO 4590 IVECO 4590	JH415647/10 32311	32024X 30221		
240-36 [- 04/87] / T.S [- 06/88] / P [6X2] T RANGE					
	IVECO 5875 IVECO 5875 ROCKWELL [U180E] ROCKWELL [U180E]	JH415647/10 32311	32221 XAA32217/Y32217		
240-38					
	IVECO 5875 IVECO 5875 IVECO 4590 IVECO 4590	JH415647/10 32311	32024X 30221		
260-25 AH [6X4]/[6X6], 260-32 AH [ARMY], 260-35 HM [6X4] [6X6]					
	IVECO 5875 IVECO 5875 IVECO 5965/5975 IVECO 5965/5975 IVECO 4590 IVECO 4590	JH415647/10 32311 32021X 33019	32024X 30221		
260-32 AH [ARMY] / 260-35 HM [6X4] [6X6]					
	IVECO 5875 IVECO 5875 IVECO 5965/5975 IVECO 5965/5975 IVECO 4590 IVECO 4590	JH415647/10 32311 32021X 33019	32024X 30221		



APPLICATION LISTINGS - TRUCK

A















IVECO							
260-25 AHW [6X6] / 260-26 NW [6X6]							
	IVECO 5875	JH415647/10					
	IVECO 5875	32311					
	IVECO 5965/5975	32021X					
	IVECO 5965/5975	33019					
	IVECO 4590		32024X				
	IVECO 4590		30221				
260-35 HWM [6X6] / 260-35 WM [6X6]							
	IVECO 5875	JH415647/10					
	IVECO 5875	32311					
	IVECO 5965/5975	32021X					
	IVECO 5965/5975	33019					
	IVECO 4590		32024X				
	IVECO 4590		30221				
300-30 AH [8X4]							
	IVECO 5875	JH415647/10					
	IVECO 5875	32311					
	IVECO 4590		32024X				
	IVECO 4590		30221				
320 D 26 AK CKD							
	IVECO 5830	30309					
	IVECO 5830	30307					
	IVECO 4519		33113				
	IVECO 4519		33113				
320-45 HWMT [6X6]							
	IVECO 5965/5975	32021X					
	IVECO 5965/5975	33019					
	IVECO 4590		32024X				
	IVECO 4590		30221				
330-25 AN [TAM], 330-26 H/HT [6X4]							
	IVECO 5875	JH415647/10					
	IVECO 5875	32311					
	IVECO 5965/5975	32021X					
	IVECO 5965/5975	33019					
	IVECO 4590		32024X				
	IVECO 4590		30221				
330-30 H/HT/HCKD/HTCKD [6X4], 330-30 N							
	IVECO 5875	JH415647/10					
	IVECO 5875	32311					
	IVECO 5965/5975	32021X					
	IVECO 5965/5975	33019					
	IVECO 4590		32024X				
	IVECO 4590		30221				
330-35 H/HCKD/HT [6X4]							
	IVECO 5875	JH415647/10					
	IVECO 5875	32311					
	IVECO 5965/5975	32021X					
	IVECO 5965/5975	33019					





APPLICATION LISTINGS - TRUCK



		 		
IVECO				
330-35 H/HCKD/HT [6X4] ...				
	IVECO 4590 IVECO 4590		32024X 30221	
330-26 HW/HTW [6X6], 330-30 HW/NW/ANW [6X6]				
	IVECO 5875 IVECO 5875 IVECO 5965/5975 IVECO 5965/5975 IVECO 4590 IVECO 4590	JH415647/10 32311 32021X 33019	32024X 30221	
330-32 ANW [6X6], 330-35 HW/CKD [6X6]				
	IVECO 5875 IVECO 5875 IVECO 5965/5975 IVECO 5965/5975 IVECO 4590 IVECO 4590	JH415647/10 32311 32021X 33019	32024X 30221	
619 T 1P / N 1P CKD				
	IVECO 5875 IVECO 5875 IVECO 4560 IVECO 4560	JH415647/10 32311	32221 6581X/6535	
EUROCARGO 60 E10/E12/E14				
	IVECO 5827 IVECO 5827 IVECO 4517 IVECO 4517	JXC25370CA/DA JXC25370CA/DA	XC2379CD/DA XC2379CD/DA	
EUROCARGO 65 E10/E12/E12 H/E14				
	IVECO 5827 IVECO 5827 IVECO 5830 IVECO 5830 IVECO 4517 IVECO 4517 IVECO 4519 IVECO 4519	JXC25370CA/DA JXC25370CA/DA 30309 30307	XC2379CD/DA XC2379CD/DA 33113 33113	
EUROCARGO 75 E13 TECTOR				
	IVECO 5827 IVECO 5827 IVECO 5833 IVECO 5833 IVECO 4517 IVECO 4517 IVECO 4521 IVECO 4521	JXC25370CA/DA JXC25370CA/DA JXC18439CA/DA JXC25370CA/DA	XC2379CD/DA XC2379CD/DA JXC25716C/D JXC25716C/D	





APPLICATION LISTINGS - TRUCK















A



IVECO							
EUROCARGO 75 E15 TECTOR							
	IVECO 5827	JXC25370CA/DA					
	IVECO 5827	JXC25370CA/DA					
	IVECO 5833	JXC15349CA/DA					
	IVECO 5833	JXC25370CA/DA					
	IVECO 4515			XC2379CD/DA			
	IVECO 4515			XC2379CD/DA			
	IVECO 4521			JXC25716C/D			
	IVECO 4521			JXC25716C/D			
EUROCARGO 75 E17 TECTOR							
	IVECO 5827	JXC25370CA/DA					
	IVECO 5827	JXC25370CA/DA					
	IVECO 5833	JXC17349CA/DA					
	IVECO 5833	JXC25370CA/DA					
	IVECO 4515			XC2379CD/DA			
	IVECO 4515			XC2379CD/DA			
	IVECO 4521			JXC25716C/D			
	IVECO 4521			JXC25716C/D			
EUROCARGO 75 E18 TECTOR							
	IVECO 5827	JXC25370CA/DA					
	IVECO 5827	JXC25370CA/DA					
	IVECO 5833	JXC18439CA/DA					
	IVECO 5833	JXC25370CA/DA					
	IVECO 4517			XC2379CD/DA			
	IVECO 4517			XC2379CD/DA			
	IVECO 4521			JXC25716C/D			
	IVECO 4521			JXC25716C/D			
EUROCARGO 75 E12/E14/E15							
	IVECO 5827	JXC25370CA/DA					
	IVECO 5827	JXC25370CA/DA					
	IVECO 5833	JXC18439CA/DA					
	IVECO 5833	JXC25370CA/DA					
	IVECO 4517			XC2379CD/DA			
	IVECO 4517			XC2379CD/DA			
	IVECO 4521			JXC25716C/D			
	IVECO 4521			JXC25716C/D			
EUROCARGO 80 E15/E18/E21							
	IVECO 5833	JXC18439CA/DA					
	IVECO 5833	JXC25370CA/DA					
	IVECO 4521			JXC25716C/D			
	IVECO 4521			JXC25716C/D			
EUROCARGO 85 E15/E18/E18 H							
		JXC18439CA/DA					
		JXC25370CA/DA					
				JXC25716C/D			
				JXC25716C/D			



APPLICATION LISTINGS - TRUCK

				 			
IVECO							
EUROCARGO 95 E15/E21 [4X4]							
		33019 32018X		33118 30215			
EUROCARGO 95 E18							
		JXC18439CA/DA JXC25370CA/DA		JXC25716C/D JXC25716C/D			
EUROCARGO 100 E21							
	IVECO 5833 IVECO 5833 IVECO 4517 IVECO 4517 IVECO 4521 IVECO 4521 ROCKWELL [F120-F125] ROCKWELL [F120-F125]	JXC18439CA/DA JXC25370CA/DA		XC2379CD/DA XC2379CD/DA JXC25716C/D JXC25716C/D 567/563 3984/3920			04/91-04/92 04/91-04/92
EUROCARGO 100 E17/E18/E21 TECTOR							
	IVECO 5833 IVECO 5833 IVECO 4521 IVECO 4521	JXC18439CA/DA JXC25370CA/DA		JXC25716C/D JXC25716C/D			
EUROCARGO 120 E23							
	IVECO 5842/5851 IVECO 5842/5851 ROCKWELL [H125-P130] ROCKWELL [H125-P130]	JXC25389CC/DA JXC25389CC/DA		XAA32217/Y32217 JM714249/10			
EUROCARGO 120 E18/E22/E25/E28 [4X2]							
	MERITOR MS08 MERITOR MS10-144			NP793154-90UA3 NP793154-90UA3			
EUROCARGO 130 E15/E18/E23							
	IVECO 5842/5851 IVECO 5842/5851 ROCKWELL [H125-P130] ROCKWELL [H125-P130]	JXC25389CC/DA JXC25389CC/DA		XAA32217/Y32217 JM714249/10			
EUROCARGO 130 E18/E25 [4X2]							
	MERITOR MS08 MERITOR MS10-144			NP793154-90UA3 NP793154-90UA3			
EUROCARGO 130 E24							
		JXC25389CC/9DA JXC25389CC/9DA		XAA32217/Y32217 JM714249/10			

A





APPLICATION LISTINGS - TRUCK



















IVECO							
EUROCARGO 135 E18/E23 [4X4]							
		32021X 33019		30221 30218			
EUROCARGO 140 E18/E22/E25/E28 [4X2]							
	MERITOR MS08 MERITOR MS10-144		NP793154-90UA3 NP793154-90UA3				
EUROCARGO 150 E15/E18/E23/E27							
	IVECO 5842/5851 IVECO 5842/5851 ROCKWELL [R130-S180] ROCKWELL [R130-S180]	JXC25389CC/DA JXC25389CC/DA		XAA32219/Y32219 XAA32217/Y32217			
EUROCARGO 150 E15 H/E18 H/E21 H/E23 H							
		JXC25381CH/DC JXC25723CH/DD		30221 30218			
EUROCARGO 150 E22/E25/E28/E30 [4X2]							
	MERITOR MS08 MERITOR MS10-144		NP793154-90UA3 NP793154-90UA3				
EUROCARGO 160 E22/E25 [4X2]							
	MERITOR MS10-164		NP240581-90UA1				
EUROCARGO 160 E28/E30 [4X2]							
	MERITOR MS13-165		NP318274-90UA7				
EUROCARGO 170 E15/E18/E23/E27							
		JXC25381CH/DC JXC25723CH/DD		XAA32219/Y32219 XAA32217/Y32217			
EUROCARGO 180 E21							
	IVECO 5833 IVECO 5833 IVECO 4521 IVECO 4521	JXC18439CA/DA JXC25370CA/DA		JXC25716C/D JXC25716C/D			
EUROCARGO 260 E23							
	IVECO 5842/5851 IVECO 5842/5851 ROCKWELL [H125-P130] ROCKWELL [H125-P130]	JXC25389CC/DA JXC25389CC/DA		XAA32217/Y32217 JM714249/10			
EUROCARGO 280 E23							
	IVECO 5842/5851 IVECO 5842/5851 ROCKWELL [R130-S180] ROCKWELL [R130-S180]	JXC25389CC/DA JXC25389CC/DA		XAA32219/Y32219 XAA32217/Y32217			





APPLICATION LISTINGS - TRUCK



					
IVECO					
EUROCARGO 320 E27					
	IVECO 5842/5851 IVECO 5842/5851 IVECO 5842/5851 IVECO 5842/5851	JXC25389CC/DA JXC25389CC/DA		XAA32219/Y32219 XAA32217/Y32217	
EUROFIRE 95 E18 W					
		33019-90KA1 32018X		30215	
EUROFIRE 135 E22 W					
		33019-90KA1 32021X		30221	
EUROFIRE 135 E24					
		33019-90KA1 32021X		30221	
EUROFIRE 140 E24 TECTOR					
		33019-90KA1 32018X		30221	
EUROFIRE 140 E28					
		33019-90KA1 32021X		30221	
EUROTECH 180 E24/E30					
		JXC25381CH/DC JXC25723CH/DD		XAA32219/Y32219 XAA32217/Y32217	
EUROTECH 180 E27/E34 MT					
		JXC25381CH/DC JXC25723CH/DD		XAA32219/Y32219 XAA32217/Y32217	
EUROTECH 180 E34 MP					
		JXC25381CH/DC JXC25723CH/DD		XAA32219/Y32219 XAA32217/Y32217	
EUROTECH 180 E38/E42					
		JXC25381CH/DC JXC25723CH/DD		XAA32219/Y32219 XAA32217/Y32217	 Ch.173789- Ch.173789-





















APPLICATION LISTINGS - TRUCK

A



IVECO					
EUROTECH 190 E24					
		JXC25381CH/DC JXC25723CH/DD	32221 XAA32217/Y32217 32221 XAA32217/Y32217		- 1824487 - 1824487 1824488 - 1824488 -
EUROTECH 190 E24 CURSOR					
	MERITOR [MS17/U177E]	JXC25381CH/DC JXC25723CH/DD	NP318274-90UA7		
EUROTECH 190 E27/E30					
		JXC25381CH/DC JXC25723CH/DD	32221 XAA32217/Y32217 32221 XAA32217/Y32217		- 1824487 - 1824487 1824488 - 1824488 -
EUROTECH 190 E30 MP					
		JXC25381CH/DC JXC25723CH/DD	32220 32219		
EUROTECH 190 E31 CURSOR					
	MERITOR [MS17/U177E]	JXC25381CH/DC JXC25723CH/DD	NP318274-90UA7		
EUROTECH 190 E34					
		JXC25381CH/DC JXC25723CH/DD	32221 XAA32217/Y32217 32221 XAA32217/Y32217		- 1824487 - 1824487 1824488 - 1824488 -
EUROTECH 190 E35 CURSOR					
	MERITOR [MS17/U177E]	JXC25381CH/DC JXC25723CH/DD	NP318274-90UA7 32024X 30221		Exc. Ratio 3.79/1 Ratio 3.79/1 Ratio 3.79/1
EUROTECH 190 E38					
		JXC25381CH/DC JXC25723CH/DD			
EUROTECH 190 E39/E43 CURSOR					
	MERITOR [MS17/U177E]	JXC25381CH/DC JXC25723CH/DD	NP318274-90UA7		

APPLICATION LISTINGS - TRUCK

					
IVECO					
EUROTECH 190 E42					
		JXC25381CH/DC JXC25723CH/DD	32221 XAA32217/Y32217 32221 XAA32217/Y32217		 - 1824487  - 1824487  1824488 -  1824488 -
EUROTECH 240 E30					
	TRAILING AXLE TRAILING AXLE	JXC25381CH/DC JXC25723CH/DD	32220 32219 JXC25381CH/DC JXC25723CH/DD		
EUROTECH 240 E 34					
	TRAILING AXLE TRAILING AXLE	JXC25381CH/DC JXC25723CH/DD	XAA32219/Y32219 XAA32217/Y32217 JXC25381CH/DC JXC25723CH/DD		
EUROTECH 260 E24/E31/E35 CURSOR					
	MERITOR [MS17/U177E] TRAILING AXLE TRAILING AXLE TRAILING AXLE TRAILING AXLE	JXC25381CH/DC JXC25723CH/DD	NP318274-90UA7 JXC25381CH/DC JXC25723CH/DD XAA32219/Y32219 XAA32217/Y32217		
EUROTECH 260 E38/E42					
		JXC25381CH/DC JXC25723CH/DD	XAA32219/Y32219 XAA32217/Y32217		
EUROTECH 260 E39/E43 CURSOR					
	MERITOR [MS17/U177E] TRAILING AXLE TRAILING AXLE	JXC25381CH/DC JXC25723CH/DD	NP318274-90UA7 JXC25381CH/DC JXC25723CH/DD		
EUROTECH 325 E27					
		JXC25381CH/DC JXC25723CH/DD	XAA32219/Y32219 XAA32217/Y32217		
EUROTECH 350/480 HP [1998]					
	MERITOR MS13-175		NP318274-90UA7		





APPLICATION LISTINGS - TRUCK

A















IVECO					
EUROTECH 400 E30/E34 MP/E34 MT					
		JXC25381CH/DC JXC25723CH/DD	XAA32219/Y32219 XAA32217/Y32217		
EUROTECH 400 E38					
		JXC25381CH/DC JXC25723CH/DD	XAA32219/Y32219 XAA32217/Y32217		Ch.173789- Ch.173789-
EUROTECH 400 E42					
		JXC25381CH/DC JXC25723CH/DD	XAA32219/Y32219 XAA32217/Y32217		
EUROTECH 440 E31/E35 CURSOR					
	MERITOR MS17 [U177E]	JXC25381CH/DC JXC25723CH/DD	NP318274-90UA7		
EUROTECH 440 E34 MP					
		JXC25381CH/DC JXC25723CH/DD	32221 XAA32217/Y32217 32221 XAA32217/Y32217		
EUROTECH 440 E38 MP					
	TRAILING AXLE TRAILING AXLE	JXC25381CH/DC JXC25723CH/DD	XAA32219/Y32219 XAA32217/Y32217 32220 32219 32221 XAA32217/Y32217 32221 XAA32217/Y32217 JXC25381CH/DC JXC25723CH/DD		-Ch.173788 -Ch.173789, - 1824487 -Ch.173789, - 1824487 -Ch.173789, 1824488 - -Ch.173789, 1824488 -
EUROTECH 440 E39/E43 CURSOR					
	MERITOR [MS17/U177E]	JXC25381CH/DC JXC25723CH/DD	NP318274-90UA7		
EUROTECH 440 E42 [4X2]					
		JXC25381CH/DC JXC25723CH/DD	32221 XAA32217/Y32217		- 1824487 - 1824487





APPLICATION LISTINGS - TRUCK



		 		
IVECO				
EUROTECH 440 E42 [4X2] ...				
			32221 XAA32217/Y32217	 1824488 -  1824488 -
EUROTECH 440 E42 [6X2]				
	TRAILING AXLE TRAILING AXLE	JXC25381CH/DC JXC25723CH/DD	XAA32219/Y32219 XAA32217/Y32217 32221 XAA32217/Y32217 32221 XAA32217/Y32217 JXC25381CH/DC JXC25723CH/DD	-Ch.173788 -Ch.173788 -Ch.173789,  - 1824487 -Ch.173789,  - 1824487 -Ch.173789,  - 1824488 - -Ch.173789,  - 1824488 -
EUROTECH 440 E42 [6X4]				
		JXC25381CH/DC JXC25723CH/DD	XAA32219/Y32219 XAA32217/Y32217	
EUROTRAKKER 180 E25 [4X4]				
		32021X 33019	32024X 30221	
EUROTRAKKER 190 E30/190 E31 [4X2]				
		JXC25381CH/DC JXC25723CH/DD	32024X 30221	
EUROTRAKKER 190 E31 [4X4]				
		32021X 33019	32024X 30221	
EUROTRAKKER 190 E34				
		JXC25381CH/DC JXC25723CH/DD	32024X 30221	
EUROTRAKKER 190 E35/E38/E44 CURSOR				
		JXC25381CH/DC JXC25723CH/DD	32024X 30221	



APPLICATION LISTINGS - TRUCK

A















IVECO							
EUROTRAKKER 190 E37							
		JXC25381CH/DC JXC25723CH/DD		32024X 30221			
EUROTRAKKER 260 E30/E34 [6X4]							
		JXC25381CH/DC JXC25723CH/DD		32024X 30221 32024X 30221		Ratio 4.23/1 Ratio 4.23/1 Exc. Ratio 4.23/1 Exc. Ratio 4.23/1	
EUROTRAKKER 260 E31/E35 CURSOR							
		JXC25381CH/DC JXC25723CH/DD		32024X 30221			
EUROTRAKKER 260 E38/E44/E48 CURSOR							
	FORWARD REAR FORWARD REAR REAR REAR	JXC25381CH/DC JXC25723CH/DD		32024X 30221 32024X 30221			
EUROTRAKKER 260 E37 [6X4]							
	FORWARD REAR FORWARD REAR REAR REAR REAR REAR REAR REAR REAR REAR	JXC25381CH/DC JXC25723CH/DD		32024X 30221 32024X 30221 32024X 30221		Ratio 4.23/1 Ratio 4.23/1 Exc. Ratio 4.23/1 Exc. Ratio 4.23/1	
EUROTRAKKER 260 E42/E47 [6X4]							
	FORWARD REAR FORWARD REAR REAR REAR REAR REAR	JXC25381CH/DC JXC25723CH/DD		32024X 30221 32024X 30221			
EUROTRAKKER 260 E42 [6X6]							
	FORWARD REAR FORWARD REAR REAR REAR REAR REAR	32021X 33019		32024X 30221 32024X 30221			



APPLICATION LISTINGS - TRUCK



						 					
IVECO											
EUROTRAKKER 330 E34/E37 [6X4]											
	IVECO 5875 IVECO 5875 IVECO 5965/5975 IVECO 5965/5975 IVECO 4590 IVECO 4590	JXC25381CH/DC JXC25723CH/DD JH415647/10 32311 32021X 33019		32024X 30221 32024X 30221							
EUROTRAKKER 340 E34/E37/E42 [8X4]											
	FORWARD FRONT FORWARD FRONT REAR FRONT REAR FRONT FORWARD REAR FORWARD REAR REAR REAR REAR REAR	JXC25381CH/DC JXC25723CH/DD JXC25381CH/DC JXC25723CH/DD		32024X 30221 32024X 30221							
EUROTRAKKER 340 E35/E38/E44 CURSOR											
	FORWARD REAR FORWARD REAR REAR REAR	JXC25381CH/DC JXC25723CH/DD		32024X 30221 32024X 30221							
EUROTRAKKER 340 E42 [6X6]											
	FORWARD REAR FORWARD REAR REAR REAR REAR REAR	32021X 33019		32024X 30221 32024X 30221							
EUROTRAKKER 380 E31/E37/E42/E47 [6X4]											
	FORWARD REAR FORWARD REAR REAR REAR REAR REAR	JXC25381CH/DC JXC25723CH/DD		32024X 30221 32024X 30221							
EUROTRAKKER 380 E31/E37/E42 [6X6]											
	FORWARD REAR FORWARD REAR REAR REAR REAR REAR	32021X 33019		32024X 30221 32024X 30221							



















APPLICATION LISTINGS - TRUCK

A















											
IVECO											
EUROTRAKKER 380 E34/E42 [6X4]											
				JXC25381CH/DC JXC25723CH/DD			32024X 30221				
EUROTRAKKER 380 E35/E38/E44/E48 CURSOR											
				JXC25381CH/DC JXC25723CH/DD			32024X 30221 32024X 30221				
		FORWARD REAR FORWARD REAR REAR REAR									
EUROTRAKKER 400 E31/E34/E37/E42 [4X2]											
				JXC25381CH/DC JXC25723CH/DD			32024X 30221				
EUROTRAKKER 400 E31/E37 [4X4]											
				32021X 33019			32024X 30221				
EUROTRAKKER 400 E35/E38/E44 CURSOR											
				JXC25381CH/DC JXC25723CH/DD			32024X 30221				
EUROTRAKKER 410 E35 [6X4] CURSOR											
				JXC25381CH/DC JXC25723CH/DD			32024X 30221 32024X 30221				
		FORWARD REAR FORWARD REAR REAR REAR									
EUROTRAKKER 410 E37/E42 [8X4]											
				JXC25381CH/DC JXC25723CH/DD JXC25381CH/DC JXC25723CH/DD			32024X 30221 32024X 30221				
		FORWARD FRONT FORWARD FRONT REAR FRONT REAR FRONT FORWARD REAR FORWARD REAR REAR REAR REAR REAR									
EUROTRAKKER 410 E38/E44/E48 CURSOR											
				JXC25381CH/DC JXC25723CH/DD			32024X 30221				
		FORWARD REAR FORWARD REAR									





APPLICATION LISTINGS - TRUCK



							
IVECO							
EUROTRAKKER 410 E38/E44/E48 CURSOR ...							
	REAR REAR			32024X 30221			
EUROTRAKKER 410 E42 [6X6]							
		32021X 33019		32024X 30221 32024X 30221			
	FORWARD REAR FORWARD REAR REAR REAR REAR REAR						
EUROTRAKKER 440 E34/E42 [6X4]							
		JXC25381CH/DC JXC25723CH/DD		32024X 30221 32024X 30221			
	FORWARD REAR FORWARD REAR REAR REAR REAR REAR						
EUROTRAKKER 440 E37 HT							
		JXC25381CH/DC JXC25723CH/DD		32024X 30221 32024X 30221 32024X 30221			Exc. Ratio 3.79/1 Exc. Ratio 3.79/1 Ratio 3.79/1 Ratio 3.79/1
	FORWARD REAR FORWARD REAR REAR REAR REAR REAR REAR REAR REAR REAR						
EUROTRAKKER 440 E38/E44 CURSOR							
		JXC25381CH/DC JXC25723CH/DD		32024X 30221 32024X 30221			
	FORWARD REAR FORWARD REAR REAR REAR REAR REAR						
EUROTRAKKER 720 E31/E37/E42/E47 [6X4]							
		JXC25381CH/DC JXC25723CH/DD		32024X 30221 32024X 30221			
	FORWARD REAR FORWARD REAR REAR REAR REAR REAR						
EUROTRAKKER 720 E31/E37/E42 [6X6]							
		32021X 33019		32024X 30221 32024X 30221			
	FORWARD REAR FORWARD REAR REAR REAR REAR REAR						



APPLICATION LISTINGS - TRUCK

A



IVECO					
EUROTRAKKER 720 E44/E48 CURSOR					
	FORWARD REAR FORWARD REAR REAR REAR REAR REAR	JXC25381CH/DC JXC25723CH/DD	32024X 30221 32024X 30221		
EUROSTAR 180 E38/E42					
		JXC25381CH/DC JXC25723CH/DD	XAA32219/Y32219 XAA32217/Y32217		
EUROSTAR 190 E38					
		JXC25381CH/DC JXC25723CH/DD	32220 32219 32221 XAA32217/Y32217 32221 XAA32217/Y32217		-Ch.173788 -Ch.173788 -Ch.173789, - 1824487 -Ch.173789, - 1824487 -Ch.173789, 1824488 - -Ch.173789, 1824488 -
EUROSTAR 190 E42					
		JXC25381CH/DC JXC25723CH/DD	32221 XAA32217/Y32217 32221 XAA32217/Y32217		-Ch.173789, - 1824487 -Ch.173789, - 1824487 -Ch.173789, 1824488 - -Ch.173789, 1824488 -
EUROSTAR 190 E39/E43 CURSOR					
	MERITOR [MS17/U177E]	JXC25381CH/DC JXC25723CH/DD	NP318274-90UA7		
EUROSTAR 190 E47/E52					
		JXC25381CH/DC JXC25723CH/DD	32221 XAA32217/Y32217 32221 XAA32217/Y32217		-Ch.173789, - 1824487 -Ch.173789, - 1824487 -Ch.173789, 1824488 - -Ch.173789, 1824488 -
EUROSTAR 240 E38					
	TRAILING AXLE TRAILING AXLE	JXC25381CH/DC JXC25723CH/DD	32220 32219 XAA32219/Y32219 XAA32217/Y32217 JXC25381CH/DC JXC25723CH/DD		-Ch.173788 -Ch.173788 Ch.173789- Ch.173789-



APPLICATION LISTINGS - TRUCK



IVECO					
EUROSTAR 240 E42/E47/E52					
	TRAILING AXLE TRAILING AXLE TRAILING AXLE TRAILING AXLE	JXC25381CH/DC JXC25723CH/DD	XAA32219/Y32219 XAA32217/Y32217 32221 XAA32217/Y32217 32221 XAA32217/Y32217 JXC25381CH/DC JXC25723CH/DD XAA32219/Y32219 XAA32217/Y32217		ID = 95mm ID = 95mm ID = 105mm, - 1824487 ID = 105mm, - 1824487 ID = 105mm, - 1824488 - ID = 105mm, - 1824488 - OE 7177196 OE 7177196 OE 7177168 OE 7177168
EUROSTAR 260 E39/E43 CURSOR					
	MERITOR [MS17/U177E] TRAILING AXLE TRAILING AXLE	JXC25381CH/DC JXC25723CH/DD	NP318274-90UA7 JXC25381CH/DC JXC25723CH/DD		
EUROSTAR 260 E42/E47/E52					
		JXC25381CH/DC JXC25723CH/DD	XAA32219/Y32219 XAA32217/Y32217		
EUROSTAR 350/480 HP [1998]					
	MERITOR MS13-175		NP318274-90UA7		
EUROSTAR 400 E38					
		JXC25381CH/DC JXC25723CH/DD	XAA32219/Y32219 XAA32217/Y32217 32220 32219		ID = 95mm ID = 95mm
EUROSTAR 400 E42/E47/E52					
		JXC25381CH/DC JXC25723CH/DD	XAA32219/Y32219 XAA32217/Y32217		
EUROSTAR 440 E38					
		JXC25381CH/DC JXC25723CH/DD	32220 32219 32221 XAA32217/Y32217 32221 XAA32217/Y32217		-Ch.173788 -Ch.173789, 1824488 - -Ch.173789, 1824488 -





APPLICATION LISTINGS - TRUCK

A

















IVECO					
EUROSTAR 440 E42/E47/E52 [4X2]					
		JXC25381CH/DC JXC25723CH/DD	32221 XAA32217/Y32217 32221 XAA32217/Y32217		- 1824487 - 1824487 1824488 - 1824488 -
EUROSTAR 440 E42/E52 [6X4]					
		JXC25381CH/DC JXC25723CH/DD	XAA32219/Y32219 XAA32217/Y32217		
EUROSTAR 440 E43/E46/E48 CURSOR					
	MERITOR [MS17/U177E]	JXC25381CH/DC JXC25723CH/DD	NP318274-90UA7		
STRALIS 190 S31/S33/S36/S42 [4X2] CURSOR					
	MERITOR MS13-175		NP318274-90UA7		
STRALIS 190 S45/S50 [4X2] CURSOR					
	MERITOR MS13-175		NP318274-90UA7		
STRALIS 260 S31/S33/S36/S42/S45 [4X2] CURSOR					
	MERITOR MS13-175		NP318274-90UA7		
STRALIS 260 S40/S43/S44/S48/S54					
	MERITOR [MS17/U177E] TRAILING AXLE TRAILING AXLE	JXC25381CH/DC JXC25723CH/DD	NP318274-90UA7 JXC25381CH/DC JXC25723CH/DD		
STRALIS 260 S50/S56 [4X2] CURSOR					
	MERITOR MS13-175		NP318274-90UA7		
STRALIS 440 S36/S42/S45/S50/S56 CURSOR [4X2]					
	MERITOR MS13-175		NP318274-90UA7		
STRALIS 440 S40/S43/S44/S48/S54					
	FORWARD FRONT FORWARD FRONT REAR FRONT REAR FRONT MERITOR [MS17/U177E]	JXC25381CH/DC JXC25723CH/DD JXC25381CH/DC JXC25723CH/DD	NP318274-90UA7		
TRAKKER [6X4]					
	MERITOR MS15		NP318274-90UA7		
TURBOSTAR 190-36					
	IVECO 5875 IVECO 5875	JH415647/10 32311			

















APPLICATION LISTINGS - TRUCK







									
IVECO									
TURBOSTAR 190-36 ...									
	ROCKWELL U SERIES ROCKWELL U SERIES			32221 XAA32217/Y32217					
TURBOSTAR 190-38 HP									
	IVECO 5875 IVECO 5875 ROCKWELL U SERIES ROCKWELL U SERIES	JH415647/10 32311		32221 XAA32217/Y32217					
TURBOSTAR 190-42/190-48									
	IVECO 5875 IVECO 5875 ROCKWELL U SERIES ROCKWELL U SERIES	JH415647/10 32311		32221 XAA32217/Y32217					
TURBOSTAR 240-36									
	IVECO 5875 IVECO 5875 ROCKWELL [U180E] ROCKWELL [U180E]	JH415647/10 32311		32221 XAA32217/Y32217					
TURBOSTAR 240-36 GV									
	IVECO 5875 IVECO 5875 ROCKWELL U SERIES ROCKWELL U SERIES TRAILING AXLE TRAILING AXLE	JH415647/10 32311		32221 XAA32217/Y32217 JH415647/10 32311					
TURBOSTAR 240-38 GV									
	IVECO 5875 IVECO 5875 ROCKWELL U SERIES ROCKWELL U SERIES TRAILING AXLE TRAILING AXLE	JH415647/10 32311		32221 XAA32217/Y32217 JH415647/10 32311					
TURBOSTAR 240-42									
	IVECO 5875 IVECO 5875 ROCKWELL [U180E] ROCKWELL [U180E]	JH415647/10 32311		32221 XAA32217/Y32217					
TURBOSTAR 240-48									
	IVECO 5875 IVECO 5875 ROCKWELL U SERIES ROCKWELL U SERIES TRAILING AXLE TRAILING AXLE	JH415647/10 32311		32221 XAA32217/Y32217 JH415647/10 32311					
TURBOSTAR 260-36/260-38/260-48									
	IVECO 5875 IVECO 5875	JH415647/10 32311							

APPLICATION LISTINGS - TRUCK



				 			
IVECO							
TURBOSTAR 260-36/260-38/260-48 ...							
	ROCKWELL U SERIES ROCKWELL U SERIES ROCKWELL [R130-S180] ROCKWELL [R130-S180] CALABRESE CALABRESE			32221 XAA32217/Y32217 XAA32219/Y32219 XAA32217/Y32217 33118 33213			
TURBOSTAR 260-36/260-42							
	IVECO 5875 IVECO 5875 ROCKWELL [U180E] ROCKWELL [U180E]	JH415647/10 32311		32221 XAA32217/Y32217			
TURBOTECH 190-24 T.R.U.							
	IVECO 5875 IVECO 5875 ROCKWELL U180E ROCKWELL U180E	JH415647/10 32311		32221 XAA32217/Y32217			-06/88 -06/88
TURBOTECH 190-26							
	IVECO 5875 IVECO 5875 IVECO 4590 IVECO 4590 ROCKWELL U SERIES ROCKWELL U SERIES	JH415647/10 32311		32024X 30221 32221 XAA32217/Y32217			
TURBOTECH 190-30							
	IVECO 5875 IVECO 5875 IVECO 4590 IVECO 4590	JH415647/10 32311		32024X 30221			
TURBOTECH 190-32 GV							
	IVECO 5875 IVECO 5875 ROCKWELL U SERIES ROCKWELL U SERIES	JH415647/10 32311		32221 XAA32217/Y32217			
TURBOTECH 190-36 GV							
	IVECO 5875 IVECO 5875 ROCKWELL U SERIES ROCKWELL U SERIES	JH415647/10 32311		32221 XAA32217/Y32217			
TURBOTECH 190-38							
	IVECO 5875 IVECO 5875 ROCKWELL U SERIES ROCKWELL U SERIES	JH415647/10 32311		32221 XAA32217/Y32217			
TURBOTECH 220-32 T.R.U.							
	IVECO 5875 IVECO 5875	JH415647/10 32311					

APPLICATION LISTINGS - TRUCK

						 					
IVECO											
TURBOTECH 220-32 T.R.U. ...											
	ROCKWELL U SERIES ROCKWELL U SERIES TRAILING AXLE TRAILING AXLE				32221 XAA32217/Y32217 JH415647/10 32311						
TURBOTECH 220-36 GV											
	IVECO 5875 IVECO 5875 ROCKWELL U SERIES ROCKWELL U SERIES TRAILING AXLE TRAILING AXLE	JH415647/10 32311			32221 XAA32217/Y32217 JH415647/10 32311						
TURBOTECH 220-38 GV											
	IVECO 5875 IVECO 5875 ROCKWELL U SERIES ROCKWELL U SERIES TRAILING AXLE TRAILING AXLE	JH415647/10 32311			32221 XAA32217/Y32217 JH415647/10 32311						
TURBOTECH 240-26											
	IVECO 5875 IVECO 5875 ROCKWELL U SERIES ROCKWELL U SERIES TRAILING AXLE TRAILING AXLE	JH415647/10 32311			32221 XAA32217/Y32217 JH415647/10 32311						
TURBOTECH 240-32 GV											
	IVECO 5875 IVECO 5875 ROCKWELL U SERIES ROCKWELL U SERIES TRAILING AXLE TRAILING AXLE	JH415647/10 32311			32221 XAA32217/Y32217 JH415647/10 32311						
TURBOTECH 240-36 GV											
	IVECO 5875 IVECO 5875 ROCKWELL U SERIES ROCKWELL U SERIES TRAILING AXLE TRAILING AXLE	JH415647/10 32311			32221 XAA32217/Y32217 JH415647/10 32311						
TURBOTECH 240-38 GV											
	IVECO 5875 IVECO 5875 ROCKWELL U SERIES ROCKWELL U SERIES TRAILING AXLE TRAILING AXLE	JH415647/10 32311			32221 XAA32217/Y32217 JH415647/10 32311						





APPLICATION LISTINGS - TRUCK

















IVECO					
TURBOTECH 260-32/260-36/260-38					
	IVECO 5875 IVECO 5875 ROCKWELL U SERIES ROCKWELL U SERIES ROCKWELL [R130-S180] ROCKWELL [R130-S180] CALABRESE CALABRESE	JH415647/10 32311	32221 XAA32217/Y32217 XAA32219/Y32219 XAA32217/Y32217 33118 33213		
TURBOTECH 260-36/260-42					
	IVECO 5875 IVECO 5875 ROCKWELL [U180E] ROCKWELL [U180E]	JH415647/10 32311	32221 XAA32217/Y32217		
TURBOZETA 60-11					
		30309 30307	32014X 32014X		
TURBOZETA 79-12					
		30309 30307	33113 33113		
ZETA 50-9/10					
		30309 30307	32014X 32014X		
ZETA 70-14					
		30309 30307	33113 33113		
ZETA 95-14					
	ROCKWELL [125E] ROCKWELL [125E]	30309 30307	567/563 3984/3920		
ZETA 109-14					
	ROCKWELL [H140E] ROCKWELL [H140E]	30309 30307	XAA32217/Y32217 JM714249/10		



APPLICATION LISTINGS - TRUCK









				 			
IVECO							
Z RANGE 50-8							
		30309 30307		32014X 32014X			
Z RANGE 60-10/65-10/75-10/79-10/79-14							
		30309 30307		33113 33113			
Z 220 STRIPPED CHASS./Z 220 T H							
		30309 30307		33113 33113			
LEYLAND							
BISON							
	6.5T, ALFORD & ALDER 6.5T, ALFORD & ALDER ALBION RA 1069/70 ALBION RA 1069/70 ALBION RA 1000 ALBION RA 1000	H414242/10 527/522		HM218248/10 HM215249/10 580/572 748S/742			1978- 1978- -1978 -1978
BOXER SERIES-BX 18 TF / BX 19 TA / BX 20 TF							
	3.5T 3.5T BMC 1&2 SPEED, EATON CENTRE BMC 1&2 SPEED, EATON CENTRE	39581/39520 3490/3420		594/592A 580/572X			
BOXER SERIES 1000							
	3.5T 3.5T BMC 1&2 SPEED, EATON CENTRE BMC 1&2 SPEED, EATON CENTRE BMC 1&2 SPEED BMC 1&2 SPEED	39581/39520 3490/3420		594/592A 580/572X 567X/563 3982/3920			
BOXER SERIES 1200/1300							
	3.5T 3.5T BMC 1&2 SPEED, EATON CENTRE BMC 1&2 SPEED, EATON CENTRE	39581/39520 3490/3420		594/592A 580/572X			
BOXER SERIES 1425							
	6.5T, ALFORD & ALDER 6.5T, ALFORD & ALDER MAUDSLAY, 10T, 1&2 SPEED MAUDSLAY, 10T, 1&2 SPEED	H414242/10 527/522		594/592A 580/572X			



APPLICATION LISTINGS - TRUCK

















     	
LEYLAND	
BUFFALO SERIES	
6.5T, ALFORD & ALDER 6.5T, ALFORD & ALDER ALBION, RA 1000 ALBION, RA 1000 GUY GUY	H414242/10 527/522 580/572X 748S/742 52400/52618 594A/592A
CLYDESDALE 2 CD RIGID	
6.5T, ALFORD & ALDER 6.5T, ALFORD & ALDER ALBION RA 1000 ALBION RA 1000 ALBION RA 1065 ALBION RA 1065-	H414242/10 527/522 759/752 748S/742 HM218248/10 HM215249/10
CLYDESDALE 2 CD TRACTOR	
5.35T, ALFORD & ALDER 5.35T, ALFORD & ALDER ALBION RA 1000 ALBION RA 1000 ALBION RA 1065 ALBION RA 1065	HM212044/11 3585/3525 759/752 748S/742 HM218248/10 HM215249/10
CONSTRUCTOR SERIES 6	
2415, 2417, 2420, 2421 2415, 2417, 2420, 2421 2421 2421 2415, 2417, 2420 2415, 2417, 2420 2415, 2417, 2420, 2421 2415, 2417, 2420, 2421 2415, 2417, 2420, 2421, ALBION AXLE 2415, 2417, 2420, 2421, ALBION AXLE	H414242/10 527/522 HM212044/11 33209 HM212749/10 33209 598X/592A 748S/742 580/572 748S/742
CONSTRUCTOR SERIES 8	
3021, 3023, 3025, 3026 3021, 3023, 3025, 3026 3021, 3023, 3025, 3026 3021, 3023, 3025, 3026	HM212749/10 33209 HM218248/10 HM215249/10
CRUISER 1615 +	
6.5T, ALFORD & ALDER 6.5T, ALFORD & ALDER 6.5T, ALFORD & ALDER 6.5T, ALFORD & ALDER	H414242/10 527/522 HM212749/10 33209
CRUISER 1621	
6.5T, ALFORD & ALDER 6.5T, ALFORD & ALDER CAM BRAKES CAM BRAKES GUY GUY	H414242/10 527/522 598X/592A 748S/742 52400/52618 594A/592A



APPLICATION LISTINGS - TRUCK









					
LEYLAND					
CRUISER 1623					
	6.5T, ALFORD & ALDER 6.5T, ALFORD & ALDER 6.5T, ALFORD & ALDER 6.5T, ALFORD & ALDER	H414242/10 527/522	HM220149/10 HM220149/10		
CRUSADER SERIES [SCAMMELL]					
	6.5T, ALFORD & ALDER 6.5T, ALFORD & ALDER 4X2, LEYLAND 4X2, LEYLAND 6X4 MAUDSLAY, 10T 6X4 MAUDSLAY, 10T	H414242/10 527/522	683/672 683/672 594/592A 594/592A		
FREIGHTER SERIES 1111/1114					
		39581/39520 3490/3420	JM714249/10 JM511946/10		
FREIGHTER SERIES 1311/1314/1411/1414					
		39581/39520 3490/3420	594/592A 580/572X		
FREIGHTER SERIES 1511					
		HM212044/11 3585/3525 HM212044/11 32209	594/592A 580/572X HM218248/10 HM215249/10		Roller Cam Brakes Roller Cam Brakes Roller Cam Brakes Roller Cam Brakes
FREIGHTER SERIES 1514					
		HM212044/11 33209	594/592A 580/572X HM218248/10 HM215249/10		Roller Cam Brakes Roller Cam Brakes Roller Cam Brakes Roller Cam Brakes
FREIGHTER SERIES 1613/1614/1615					
		H414242/10 527/522 HM212044/11 33209	HM218248/10 HM215249/10		Roller Cam Brakes Roller Cam Brakes Roller Cam Brakes Roller Cam Brakes



APPLICATION LISTINGS - TRUCK









     	
LEYLAND	
HANDYMAN SERIES [SCAMMELL]	
6.5T, ALFORD & ALDER 6.5T, ALFORD & ALDER ALBION RA 1065 ALBION RA 1065	H414242/10 527/522 HM218248/10 HM215249/10
LYNX SERIES 2LX/3LX/4LX TRACTOR	
5.35T, ALFORD & ALDER 5.35T, ALFORD & ALDER GUY GUY	HM212044/11 3585/3525 52400/52618 594A/592A
LYNX SERIES 2LX/3LX/4LX RIGID	
6.5T, ALFORD & ALDER 6.5T, ALFORD & ALDER ALBION RA 1065 ALBION RA 1065	H414242/10 527/522 HM218248/10 HM215249/10
MARATHON SERIES TRACTOR [34T/38T]	
6.5T, ALFORD & ALDER 6.5T, ALFORD & ALDER GUY GUY 4X2 LEYLAND 4X2 LEYLAND	H414242/10 527/522 52400/52618 594A/592A 683/672 683/672
REIVER SERIES 2RE	
6.5T, ALFORD & ALDER 6.5T, ALFORD & ALDER ALBION RA 1000 ALBION RA 1000	H414242/10 527/522 580/572X 748S/742
REIVER SERIES RE 29/RE 31	
	558/552A 527/522 580/572X 748S/742
RELIANCE SERIES	
LEYLAND LEYLAND 6.5T, ALFORD & ALDER 6.5T, ALFORD & ALDER LEYLAND	6379/6320 615/612 H414242/10 527/522 594/592A
ROADTRAIN	
6.5T, ALFORD & ALDER 6.5T, ALFORD & ALDER LEYLAND, 13T LEYLAND, 13T LEYLAND RATIONALISED, 17T LEYLAND RATIONALISED, 17T LEYLAND, 10T LEYLAND, 10T	H414242/10 527/522 683/672 683/672 HM220149/10 HM220149/10 HM212749/10 33209



APPLICATION LISTINGS - TRUCK













					
LEYLAND					
ROUTEMAN SERIES [SCAMMELL]					
	6.5T, ALFORD & ALDER 6.5T, ALFORD & ALDER 5T, ALFORD & ALDER 5T, ALFORD & ALDER ALBION RA 1069/70 ALBION RA 1069/70	H414242/10 527/522 HM212044/11 3585/3525		HM218248/10 HM215249/10	
TRUNKER SERIES [SCAMMELL]					
	LEYLAND LEYLAND 6.5T, ALFORD & ALDER 6.5T, ALFORD & ALDER	558/552A 527/522 H414242/10 527/522		683/672 683/672	3 3
MAN					
6/8T [4X2]-F SERIES L01					
	V7-36 L V7-36 L W 6.1T W 6.8T	EK50024 32207		39590/39520 39590/39520	
8/9T [4X2]-FOC SERIES L05					
	V7-36 L V7-36 L W 6.1T W 6.8T	EK50024 32207		39590/39520 39590/39520	
10T [4X2]-F SERIES L04					
	V7-36 L V7-36 L W 6.8T	EK50024 32207		39590/39520	
12T [4X4]-FA SERIES M07					
	VA7-0540 VA7-0540 HY-0955 HY-0955 H7-0870 H7-0870	32017X 32015X		30218 33115 32018X 32215	
12/13T [4X2]-F SERIES M01					
	V7-42 L V7-52 L HY-0955 HY-0955 HY-1175 HY-1175	32208 33209		30218 33115 30218 33115	



APPLICATION LISTINGS - TRUCK















 		 			
MAN					
12/13T [4X2]-FL SERIES M02					
	V7-42 L V7-52 L HY-0955 HY-0955 HY-1175 HY-1175	32208 33209		30218 33115 30218 33115	
14/15 T [4X2]-F SERIES M03					
	V7-52 L HY-0955 HY-0955 HY-1175 HY-1175	33209		30218 33115 30218 33115	
14/15T [4X2]-FL SERIES M04					
	V7-52 L HY-0955 HY-0955 HY-1175 HY-1175	33209		30218 33115 30218 33115	
16/19T [4X2]-F SERIES F01					
	V9-75 L V9-75 L HY-13110 HY-13110 H9-16120 H9-13120 H9-13120 H9-13120 H9-10120 H9-10120	EK50001 32310		EK50021 33019 33022 33022 33022 30220 33021 32019X	07/90 - 06/86-07/90 06/86-07/90
16/19T [4X2]-FL SERIES F02					
	V9-75 L V9-75 L H9-10120 H9-10120 HY-13110 HY-13110 H9-13120 H9-13120	EK50001 32310		33021 32019X EK50021 33019 33022 30220	
16/19T [4X2]-FLL SERIES F03					
	V9-65 L V9-65 L V9-75 L V9-75 L HY-13110 HY-13110 H9-13120 H9-13120	EK50001 32310 EK50001 32310		EK50021 33019 33022 30220	











APPLICATION LISTINGS - TRUCK















									
MAN									
16/19T [4X2]-U SERIES U01									
	V9-75 L V9-75 L H9-10120 H9-10120 H9-13120 H9-13120 HY-13110 HY-13110	EK50001 32310		33021 32019X 33022 30220 EK50021 33019					
17/18T [4X2]-FL SERIES M06									
	VF-65 L VF-80 L VF-80 L HY-0955 HY-0955 HY-1175 HY-1175 H7-1080 H7-1080 H7-1080 H7-1080 H7-1180 H7-1180 H7-1180 H7-1180	32309 EK50001 32310		30218 33115 EK50021 33019 EK50021 32019X EK50021 32019X EK50021 32019X EK50021 32019X			01/90 - 01/90 -		
19T [4X2]-F SERIES F21									
	V9-75 L V9-75 L HY-13110 HY-13110 H9-13120 H9-13120	EK50001 32310		EK50021 33019 33022 30220					
19T [4X2]-FL SERIES F22									
	V9-75 L V9-75 L HY-13110 HY-13110 H9-13120 H9-13120	EK50001 32310		EK50021 33019 33022 30220					
19T [4X4]-FA SERIES F04									
	VA9-0950 VA9-0950 H9-13120 H9-13120 H9-13120 H9-13120 H9-16120	XGA32021X/Y32021X 32019X		33022 30220 33022 30220 33022					

APPLICATION LISTINGS - TRUCK



							
MAN							
22/24/25/26T [6X2]-FNL SERIES F25							
	V9-75 L V9-75 L HN9-75 HN9-75 H9-13120 H9-13120 H9-13120 H9-13120 HY-13110 HY-13110	EK50001 32310		EK50001 32310 33022 30220 33022 30220 EK50021 33019			
22/24/25/26T [6X2]-FNLL SERIES F06							
	V9-75 L V9-75 L HN9-75 HN9-75 HY-13110 HY-13110 H9-13120 H9-13120 H9-13120 H9-13120	EK50001 32310		EK50001 32310 EK50021 33019 33022 30220 33022 30220			
22/24/25/26T [6X2]-FVL SERIES F07							
	V9-75 L V9-75 L HY-13110 HY-13110 H9-13120 H9-13120	EK50001 32310		EK50021 33019 33022 30220			
22/24/25/26T [6X2]- UNL SERIES U15							
	V9-75 L V9-75 L HY-13110 HY-13110 H9-13120 H9-13120 HN9-75 HN9-75	EK50001 32310		EK50021 33019 33022 30220 EK50001 32310			
24T [6X2]-FNL SERIES M09							
	VF-65 L VF-80 L VF-80 L HY-1175 HY-1175 H7-1080 H7-1080 H7-1080 H7-1080 HN7-67 H9-1180 H9-1180	32309 EK50001 32310		EK50021 33019 EK50021 32019X EK50021 32019X 32309 EK50021 32019X			

APPLICATION LISTINGS - TRUCK

					
MAN					
24T [6X2/4]-FVL SERIES M10					
	V7-80 L V7-80 L H7-1080/ H7-1180 H7-1080/ H7-1180 HY-1175 HY-1175 H7-1080/ H7-1180 H7-1080/ H7-1180 H9-1180 H9-1180	EK50001 32310	EK50021 32019X EK50021 33019 EK50021 32019X EK50021 32019X		
26T [4X2]-FNLL SERIES F19					
	V9-75 L V9-75 L HY-13110 HY-13110 H9-13120 H9-13120 HN9-75 HN9-75	EK50001 32310	EK50021 33019 33022 30220 EK50001 32310		
26/27/28/30/32/33T [6X6]-DFA SERIES F10					
	VA9-0950 VA9-0950 H9-1080/1180 H9-1080/1180 H9-1080/1180 H9-1080/1180 HD9-16120 HD9-1380 HD9-1080/1180 HD9-1080/1180 HD9-1380 HD9-1380 HD9-13120 HD9-13120 HD9-13120	XGA32021X/Y32021X 32019X	EK50021 32019X EK50021 32019X 33022 33022 EK50021 32019X 33022 30220 33022 30220 33022	 81.35701.0081 81.35701.0141 81.35701.0141 81.35701.0127 81.35701.0127 81.35701.0081	
26/27/28/30/32/33T [6X4]-DF SERIES F 09					
	V9-75 L V9-75 L V9-90 L V9-90 L HD7-1380 HD7-1380 HD9-1080/1180 HD9-1080/1180 HD9-16120 HD9-1380 HD9-1380 HD9-1380 HD9-1380 HD9-1380 HD9-13120	EK50001 32310 XGA32021X/Y32021X 32019X	33022 30220 EK50021 32019X 33022 33022 30220 33022 30220 33022 33022	 81.35701.0127 81.35701.0127 20"  20"  81.35701.0081 81.35701.0127	













APPLICATION LISTINGS - TRUCK



MAN							
26/27/28/30/32/33T [6X4]-DF SERIES F 09 ...							
	HD9-13120		30220				
	HD9-13120		33022				
32/35/41T-VFA SERIES E15 [8X8/4] [8X6/4] [8X4/4]							
	VA9-0950	XGA32021X/Y32021X					
	VA9-0950	32019X					
	VA9-90 L	XGA32021X/Y32021X					
	VA9-90 L	32019X					
	HD9-1080/1180		EK50021				
	HD9-1080/1180		32019X				
	HD9-1380		33022				
	HD9-1380		30220				
	HD9-1080/1180		EK50021				
	HD9-1080/1180		32019X				
	HD9-13120		33022				
	HD9-13120		30220				
	HD9-13120		33022				
	HD9-13120		30220				
	HD9-1380		33022				
38/40T [6X6]-DFA SERIES F12							
	VA9-0950	XGA32021X/Y32021X					
	VA9-0950	32019X					
	HD9-16120		33022				
40T [6X4]-DF SERIES F11							
	V9-90 L	XGA32021X/Y32021X					
	V9-90 L	32019X					
	HD9-16120		33022				
41T-VFA SERIES E15							
	V9-90 L	XGA32021X/Y32021X					
	V9-90 L	32019X					
	HD9-1380/H9-1380		33022				
	HD9-1380/H9-1380		30220				
	HD9-1080/H9-1080		EK50021				
	HD9-1080/H9-1080		32019X				
	HD9-13120/H9-13120		33022				
	HD9-13120/H9-13120		30220				
ECONIC 2628							
	VL 4/52 DC-7.5	EK50031					



APPLICATION LISTINGS - TRUCK







				 			
MAN							
F/L/M 2000 SERIES							
	V9-32 L	33206					-04/94
	V9-32 L	33206					05/94 -
	V9-34 L	EK50024					-04/94
	V9-34 L	32207					-04/94
	V9-34 L	EK50024					05/94 -
	V9-34 L	32207					05/94 -
	V9-40 L	EK50024					-04/94
	V9-40 L	32207					-04/94
	V9-40 L	EK50024					05/94 -
	V9-40 L	32207					05/94 -
	V9-42 L	EK50024					05/94 -
	V9-42 L	32207					05/94 -
	V9-50 L/V9-60 L	33209					-07/96
	V9-50 L/V9-60 L	33209					08/96 - ,  19.5 "
	V9-50 L/V9-60 L	33209					08/96 - ,  20/22.5 "
	V9-67 L	33209					
	V9-75 L/V9-80 L	EK50001					
	V9-75 L/V9-80 L	32310					
	VA9-0540	32017X					
	VA9-0540	32015X					
	VA9-0950	XGA32021X/Y32021X					
	VA9-0950	32019X					
	HY-0645/HY-0745		39590/39520				
	HY-0855		33015				
	HY-0955/HY-1175		30218				
	HY-0955/HY-1175		33115				
	HY-13110		EK50021				
	HY-13110		33019				
	HN9-75		EK50001				
	HN9-75		32310				
	H9-0670		32017X				
	H9-0670		32015X				
	H9-1180		EK50021				
	H9-1180		32019X				
	H9-1380/13120		33022				
	H9-1380/13120		30220				
	HD9-1180		EK50021				
	HD9-1180		32019X				
	HD9-1380/13120		33022				
	HD9-1380/13120		30220				
	HD9-16120		33022				
TGA 18T [4X4] BB D28							
	H9-13120		33022				
	H9-13120		30220M				
	HP-1652		33022				
TGA 26T [6X4] BB D28							
	H9-13120		33022				
	H9-13120		30220M				
	H9-16120		33022				
	HP-1652		33022				





APPLICATION LISTINGS - TRUCK



     	
MAN	
TGA 26T [6X6] BB D20	
HD9-13120 HD9-13120	33022 30220M
TGA 32T [8X4] BB D28	
H9-13120 H9-13120	33022 30220M
TGA 33T [6X2-2] BL D28	
H9-13120 H9-13120	33022-9X026 30220M
TGA 33T [6X4] BB D28	
H9-13120 H9-13120 H9-16120 HP-1652	33022 30220M 33022 33022
TGA 33T [6X6] BB D20	
HD9-13120 HD9-13120	33022 30220M
TGA 35T [8X4] BB D28	
H9-13120 H9-13120	33022 30220M
TGA 41T [8X6] BB D28	
H9-13120 H9-13120	33022 30220M
TGA 41T [8X4] BB-WW D28	
H9-13120 H9-13120 H9-16120	33022 30220M 33022
TGA 41T [8X4/4] BB/BL D28	
H9-13120 H9-13120	33022 30220M
TGA 50T [8X4] BB-WW D28	
H9-13120 H9-13120 H9-16120	33022 30220M 33022
MERCEDES-BENZ	
ACTROS 1800 SERIES	
VL 4/27 D-7.5 VL 4/27 D-7.5 VL 4/27 D-7.5 VL 4/27 D-7.5 VL 4/50 DC-7.5 VL 4/50 DC-7.5	EK50031 32310 EK50031 32310 32314 32310



APPLICATION LISTINGS - TRUCK

A













































MERCEDES-BENZ					
ACTROS 1800 SERIES ...					
	VL 4/50 DC-7.5	32312			9423340801
	VL 4/50 DC-7.5	EK50031			9423340701
	VL 4/50 DC-7.5	32312			9423340701
	VL 4/51 DC-7.5	32314			
	VL 4/51 DC-7.5	32310			
	VL 4/51 DC-7.5	32312			9423340801
	VL 4/51 DC-7.5	EK50031			9423340701
	VL 4/51 DC-7.5	32312			9423340701
	VL 4/52 DC-7.5	32314			
	VL 4/52 DC-7.5	32310			
	VL 4/52 DC-7.5	32312			9423340801
	VL 4/52 DC-7.5	EK50031			9423340701
	VL 4/52 DC-7.5	32312			9423340701
	VL 4/53 DC-7.5	32314			
	VL 4/53 DC-7.5	32310			
	VL 4/53 DC-7.5	32312			9423340801
	VL 4/53 DC-7.5	EK50031			9423340701
	VL 4/53 DC-7.5	32312			9423340701
	VL 4/54 DC-8	32314			
	VL 4/54 DC-8	32310			
	VL 4/54 DC-8	32312			9423340801
	VL 4/54 DC-8	EK50031			9423340701
	VL 4/54 DC-8	32312			9423340701
	VL 4/55 D-7.5	32314			
	VL 4/55 D-7.5	32310			
	VL 4/55 D-7.5	32312			9423340801
	VL 4/55 D-7.5	EK50031			9423340701
	VL 4/55 D-7.5	32312			9423340701
	VL 4/55 D-7.5	32310			
	VL 4/56 D-7.5	32314			
	VL 4/56 D-7.5	32310			
	VL 4/56 D-7.5	32312			9423340801
	VL 4/56 D-7.5	EK50031			9423340701
	VL 4/56 D-7.5	32312			9423340701
	VL 4/57 D-7.1	EK50011			446052
	VL 4/57 D-7.1	EK50031			446053-
	VL 4/57 D-7.1	32310			
	VL 5/1 D-9	JH415647/10			
	VL 5/1 D-9	32311			
	VL 5/1 D-9	32311			
	VL 5/1 D-9	32311			
	VL 5/20 DC-9	32311			
	VL 5/20 DC-9	32311			
	VL 5/21 DC-9	32311			
	VL 5/21 DC-9	32311			
	HL 7/052 DS-11.5		33022		3463563001
	HL 7/052 DS-13		33021		3553564401
	HL 7/052 DS-13		32020X		3553564401
	HL 7/052 DS-13		33022		3553563001
	HL 7/50 DC-11.5		33021		3553564401
	HL 7/50 DC-11.5		32020X		3553564401
	HL 7/50 DC-11.5		33022		3553563001
	HL 7/50 DCGS-11.5		33021		3553564401
	HL 7/50 DCGS-11.5		32020X		3553564401









APPLICATION LISTINGS - TRUCK



									
MERCEDES-BENZ									
ACTROS 1800 SERIES ...									
	HL 7/50 DCGS-11.5				33022				 3553563001
	HL 7/50 DCS-11.5				33021				 3553564401
	HL 7/50 DCS-11.5				32020X				 3553564401
	HL 7/50 DCS-11.5				33022				 3553563001
	HL 7/50 DCS-13				33021				 3553564401
	HL 7/50 DCS-13				32020X				 3553564401
	HL 7/50 DCS-13				33022				 3553563001
	HL 7/52 DS-11.5				33021				 3553564401
	HL 7/52 DS-11.5				32020X				 3553564401
	HL 7/52 DS-11.5				33022				 3553563001
	HL 7/53 DS-16				33021				 3553564401
	HL 7/53 DS-16				32020X				 3553564401
	HL 7/53 DS-16				33022				 3553563001
	NS 4.50 DC-10				33020				
	NS 4.50 DC-10				33116				
	NS 4/50 DCL-7.5				EK50031				
	NS 4/50 DCL-7.5				32312				
ACTROS 1900 SERIES									
	VL 4/50 DC-7.5		EK50031						 942334001, 9493340501
	VL 4/50 DC-7.5		32310						 942334001, 9493340501
	VL 4/51 DC-7.5		EK50031						 942334001, 9493340501
	VL 4/51 DC-7.5		32310						 942334001, 9493340501
	VL 4/52 DC-7.5		EK50031						 942334001, 9493340501
	VL 4/52 DC-7.5		32310						 942334001, 9493340501
	VL 4/53 DC-7.5		EK50031						 942334001, 9493340501
	VL 4/53 DC-7.5		32310						 942334001, 9493340501
	VL 4/54 DC-8		EK50031						 942334001, 9493340501
	VL 4/54 DC-8		32310						 942334001, 9493340501
	VL 4/55 D-7.5		EK50031						 942334001, 9493340501
	VL 4/55 D-7.5		32310						 942334001, 9493340501
	VL 4/56 D-7.5		EK50031						 942334001, 9493340501
	VL 4/56 D-7.5		32310						 942334001, 9493340501
	VL 5/1 D -9		32311						 942334001, 9493340501
	VL 5/1 D -9		32311						 942334001, 9493340501
	VL 5/1 D -9		32311						 942334001, 9493340501
	VL 5/1 D -9		JH415647/10						 942334001, 9493340501
	VL 5/20 DC-9		32311						
	VL 5/20 DC-9		32311						
	VL 5/21 DC-9		32311						
	VL 5/21 DC-9		32311						
	HL 7/052 DS-13				33022				 3463563001
	HL 7/50 DC-11.5				33022				 3463563001
	HL 7/50 DCGS-11.5				33022				 3463563001
	HL 7/50 DCS-11.5				33022				 3463563001
	HL 7/50 DCS-13				33022				 3463563001
	HL 7/52 DS-11.5				33022				 3463563001
	HL 7/53 DS-16				33022				 3463563001
	NS 4/50 DCL-7.5				EK50031				
ACTROS 2000 SERIES									
	AL 7/52 D-7.5		33019-90KA1						
	AL 7/52 D-7.5		XGA32021X-90KA1						
	AL 7/52 D-9		33019-90KA1						



APPLICATION LISTINGS - TRUCK

					
MERCEDES-BENZ					
ACTROS 2000 SERIES ...					
	AL 7/52 D-9	XGA32021X-90KA1			
	AL 7/52 DS-7.5	33019-90KA1			
	AL 7/52 DS-7.5	XGA32021X-90KA1			
	VL 4/50 DC-7.5	32314			
	VL 4/50 DC-7.5	32310			
	VL 4/50 DC-7.5	32312			
	VL 4/50 DC-7.5	EK50031			
	VL 4/50 DC-7.5	32312			
	VL 4/51 DC-7.5	32314			
	VL 4/51 DC-7.5	32310			
	VL 4/51 DC-7.5	32312			
	VL 4/51 DC-7.5	EK50031			
	VL 4/51 DC-7.5	32312			
	VL 4/51 DC-7.5	32314			
	VL 4/52 DC-7.5	32310			
	VL 4/52 DC-7.5	32312			
	VL 4/52 DC-7.5	EK50031			
	VL 4/52 DC-7.5	32312			
	VL 4/53 DC-7.5	32314			
	VL 4/53 DC-7.5	32310			
	VL 4/53 DC-7.5	32312			
	VL 4/53 DC-7.5	EK50031			
	VL 4/53 DC-7.5	32312			
	VL 4/54 DC-8	32314			
	VL 4/54 DC-8	32310			
	VL 4/54 DC-8	32312			
	VL 4/54 DC-8	EK50031			
	VL 4/54 DC-8	32312			
	VL 4/55 D-7.5	32314			
	VL 4/55 D-7.5	32310			
	VL 4/55 D-7.5	32312			
	VL 4/55 D-7.5	EK50031			
	VL 4/55 D-7.5	32312			
	VL 4/56 D-7.5	32314			
	VL 4/56 D-7.5	32310			
	VL 4/56 D-7.5	32312			
	VL 4/56 D-7.5	EK50031			
	VL 4/56 D-7.5	32312			
	VL 4/57 D-7.1	EK50011			
	VL 4/57 D-7.1	EK50031			
	VL 4/57 D-7.1	32310			
	VL 5/1 D-9	JH415647/10			
	VL 5/1 D-9	32311			
	VL 5/1 D-9	32311			
	VL 5/1 D-9	32311			
	VL 5/20 DC-9	32311			
	VL 5/20 DC-9	32311			
	VL 5/21 DC-9	32311			
	VL 5/21 DC-9	32311			
	HL 7/052 DS-13		33021		
	HL 7/052 DS-13		32020X		
	HL 7/052 DS-13		33022		
	HL 7/052 DS-13		33022		
	HL 7/50 DC-11.5		33021		



APPLICATION LISTINGS - TRUCK











































A



MERCEDES-BENZ					
ACTROS 2000 SERIES ...					
	HL 7/50 DC-11.5		32020X		3553564401
	HL 7/50 DC-11.5		33022		3553563001
	HL 7/50 DCGS-11.5		33021		3553564401
	HL 7/50 DCGS-11.5		32020X		3553564401
	HL 7/50 DCGS-11.5		33022		3553563001
	HL 7/50 DCS-11.5		33021		3553564401
	HL 7/50 DCS-11.5		32020X		3553564401
	HL 7/50 DCS-11.5		33022		3553563001
	HL 7/50 DCS-13		33021		3553564401
	HL 7/50 DCS-13		32020X		3553564401
	HL 7/50 DCS-13		33022		3553563001
	HL 7/52 DS-11.5		33021		3553564401
	HL 7/52 DS-11.5		32020X		3553564401
	HL 7/52 DS-11.5		33022		3553563001
	HL 7/53 DS-16		33021		3553564401
	HL 7/53 DS-16		32020X		3553564401
	HL 7/53 DS-16		33022		3463563001
	NS 4.50 DC-10		33020		
	NS 4.50 DC-10		33116		
	NS 4/50 DCL-7.5		EK50031		
	NS 4/50 DCL-7.5		32312		
ACTROS 2500 SERIES					
	VL 4/50 DC-7.5	32314			
	VL 4/50 DC-7.5	32310			
	VL 4/50 DC-7.5	32312			942 334 0801
	VL 4/50 DC-7.5	EK50031			942 334 0701
	VL 4/50 DC-7.5	32312			942 334 0701
	VL 4/51 DC-7.5	32314			
	VL 4/51 DC-7.5	32310			
	VL 4/51 DC-7.5	32312			942 334 0801
	VL 4/51 DC-7.5	EK50031			942 334 0701
	VL 4/51 DC-7.5	32312			942 334 0701
	VL 4/52 DC-7.5	32314			
	VL 4/52 DC-7.5	32310			
	VL 4/52 DC-7.5	32312			942 334 0801
	VL 4/52 DC-7.5	EK50031			942 334 0701
	VL 4/52 DC-7.5	32312			942 334 0701
	VL 4/53 DC-7.5	32314			
	VL 4/53 DC-7.5	32310			
	VL 4/53 DC-7.5	32312			942 334 0801
	VL 4/53 DC-7.5	EK50031			942 334 0701
	VL 4/53 DC-7.5	32312			942 334 0701
	VL 4/54 DC-8	32314			
	VL 4/54 DC-8	32310			
	VL 4/54 DC-8	32312			942 334 0801
	VL 4/54 DC-8	EK50031			942 334 0701
	VL 4/54 DC-8	32312			942 334 0701
	VL 4/55 D-7.5	32314			
	VL 4/55 D-7.5	32310			
	VL 4/55 D-7.5	32312			942 334 0801
	VL 4/55 D-7.5	EK50031			942 334 0701
	VL 4/55 D-7.5	32312			942 334 0701
	VL 4/56 D-7.5	32314			













































APPLICATION LISTINGS - TRUCK



		 		
MERCEDES-BENZ				
ACTROS 2500 SERIES ...				
	VL 4/56 D-7.5	32310		
	VL 4/56 D-7.5	32312		 942 334 0801
	VL 4/56 D-7.5	EK50031		 942 334 0701
	VL 4/56 D-7.5	32312		 942 334 0701
	VL 4/57 D-7.1	EK50011		 - 446052
	VL 4/57 D-7.1	EK50031		 446053-
	VL 4/57 D-7.1	32310		
	VL 5/1 D-9	JH415647/10		
	VL 5/1 D-9	32311		
	VL 5/1 D-9	32311		
	VL 5/1 D-9	32311		
	VL 5/20 DC-9	32311		
	VL 5/20 DC-9	32311		
	VL 5/21 DC-9	32311		
	VL 5/21 DC-9	32311		
	HL 7/052 DS-13		33021	 3553564401
	HL 7/052 DS-13		32020X	 3553564401
	HL 7/052 DS-13		33022	 3553563001
	HL 7/052 DS-13	EK50338		 3553563001
	HL 7/50 DC-11.5		33021	 3553564401
	HL 7/50 DC-11.5		32020X	 3553564401
	HL 7/50 DC-11.5		33022	 3553563001
	HL 7/50 DC-11.5	EK50338		 3553563001
	HL 7/50 DCGS-11.5		33021	 3553564401
	HL 7/50 DCGS-11.5		32020X	 3553564401
	HL 7/50 DCGS-11.5		33022	 3553563001
	HL 7/50 DCGS-11.5	EK50338		 3553563001
	HL 7/50 DCS-11.5		33021	 3553564401
	HL 7/50 DCS-11.5		32020X	 3553564401
	HL 7/50 DCS-11.5		33022	 3553563001
	HL 7/50 DCS-11.5	EK50338		 3553563001
	HL 7/50 DCS-13		33021	 3553564401
	HL 7/50 DCS-13		32020X	 3553564401
	HL 7/50 DCS-13		33022	 3553563001
	HL 7/50 DCS-13	EK50338		 3553563001
	HL 7/52 DS-11.5		33021	 3553564401
	HL 7/52 DS-11.5		32020X	 3553564401
	HL 7/52 DS-11.5		33022	 3553563001
	HL 7/52 DS-11.5	EK50338		 3553563001
	NS 4.50 DC-10		33020	
	NS 4.50 DC-10		33116	
	NS 4/50 DCL-7.5		EK50031	
	NS 4/50 DCL-7.5		32312	
ACTROS 2600 SERIES				
	VL 4/50 DC-7.5	32314		
	VL 4/50 DC-7.5	32310		 942 334 0801
	VL 4/50 DC-7.5	32312		 942 334 0701
	VL 4/50 DC-7.5	EK50031		 942 334 0701
	VL 4/50 DC-7.5	32312		
	VL 4/51 DC-7.5	32314		
	VL 4/51 DC-7.5	32310		 942 334 0801
	VL 4/51 DC-7.5	32312		 942 334 0701
	VL 4/51 DC-7.5	EK50031		















































APPLICATION LISTINGS - TRUCK



 		 		
MERCEDES-BENZ				
ACTROS 2600 SERIES ...				
	VL 4/51 DC-7.5	32312		 942 334 0701
	VL 4/52 DC-7.5	32314		
	VL 4/52 DC-7.5	32310		
	VL 4/52 DC-7.5	32312		 942 334 0801
	VL 4/52 DC-7.5	EK50031		 942 334 0701
	VL 4/52 DC-7.5	32312		 942 334 0701
	VL 4/53 DC-7.5	32314		
	VL 4/53 DC-7.5	32310		
	VL 4/53 DC-7.5	32312		 942 334 0801
	VL 4/53 DC-7.5	EK50031		 942 334 0701
	VL 4/53 DC-7.5	32312		 942 334 0701
	VL 4/54 DC-8	32314		
	VL 4/54 DC-8	32310		
	VL 4/54 DC-8	32312		 942 334 0801
	VL 4/54 DC-8	EK50031		 942 334 0701
	VL 4/54 DC-8	32312		 942 334 0701
	VL 4/55 D-7.5	32314		
	VL 4/55 D-7.5	32310		
	VL 4/55 D-7.5	32312		 942 334 0801
	VL 4/55 D-7.5	EK50031		 942 334 0701
	VL 4/55 D-7.5	32312		 942 334 0701
	VL 4/56 D-7.5	32314		
	VL 4/56 D-7.5	32310		
	VL 4/56 D-7.5	32312		 942 334 0801
	VL 4/56 D-7.5	EK50031		 942 334 0701
	VL 4/56 D-7.5	32312		 942 334 0701
	VL 4/57 D-7.1	EK50011		 446052
	VL 4/57 D-7.1	EK50031		 446053-
	VL 4/57 D-7.1	32310		
	VL 5/1 D-9	JH415647/10		
	VL 5/1 D-9	32311		
	VL 5/1 D-9	32311		
	VL 5/1 D-9	32311		
	VL 5/20 DC-9	32311		
	VL 5/20 DC-9	32311		
	VL 5/21 DC-9	32311		
	VL 5/21 DC-9	32311		
	HL 7/052 DS-13		33021	 3553564401
	HL 7/052 DS-13		32020X	 3553564401
	HL 7/052 DS-13		33022	 3553563001
	HL 7/052 DS-13		EK50338	3553563001
	HL 7/50 DC-11.5		33021	3553564401
	HL 7/50 DC-11.5		32020X	3553564401
	HL 7/50 DC-11.5		33022	3553563001
	HL 7/50 DC-11.5		EK50338	3553563001
	HL 7/50 DCGS-11.5		33021	3553564401
	HL 7/50 DCGS-11.5		32020X	3553564401
	HL 7/50 DCGS-11.5		33022	3553563001
	HL 7/50 DCGS-11.5		EK50338	3553563001
	HL 7/50 DCS-11.5		33021	3553564401
	HL 7/50 DCS-11.5		32020X	3553564401
	HL 7/50 DCS-11.5		33022	3553563001
	HL 7/50 DCS-11.5		EK50338	3553563001
	HL 7/50 DCS-13		33021	3553564401

APPLICATION LISTINGS - TRUCK



								
MERCEDES-BENZ								
ACTROS 2600 SERIES ...								
	HL 7/50 DCS-13		32020X		 3553564401			
	HL 7/50 DCS-13		33022		 3553563001			
	HL 7/50 DCS-13		EK50338		 3553563001			
	HL 7/52 DS-11.5		33021		 3553564401			
	HL 7/52 DS-11.5		32020X		 3553564401			
	HL 7/52 DS-11.5		33022		 3553563001			
	HL 7/52 DS-11.5		EK50338		 3553563001			
	NS 4.50 DC-10		33020					
	NS 4.50 DC-10		33116					
	NS 4/50 DCL-7.5		EK50031					
	NS 4/50 DCL-7.5		32312					
ACTROS 3200 SERIES								
	VL 4/53 DC-7.5	32314				 9423340801		
	VL 4/53 DC-7.5	32310				 942 334 0701		
	VL 4/53 DC-7.5	32312		 942 334 0701				
	VL 4/53 DC-7.5	EK50031						
	VL 4/53 DC-7.5	32312						
	VL 4/55 D-7.5	32314		 9423340801				
	VL 4/55 D-7.5	32310		 942 334 0701				
	VL 4/55 D-7.5	32312		 942 334 0701				
	VL 4/55 D-7.5	EK50031		 942 334 0701				
	VL 4/55 D-7.5	32312		 446052				
	VL 4/57 D-7.1	EK50011		 446053-				
	VL 4/57 D-7.1	EK50031						
	VL 4/57 D-7.1	32310						
	HL 7/052 DS-13		33021	 3553564401				
	HL 7/052 DS-13		32020X	 3553564401				
	HL 7/052 DS-13		33022	 3553563001				
	HL 7/50 DC-11.5		33021	 3553564401				
	HL 7/50 DC-11.5		32020X	 3553564401				
	HL 7/50 DC-11.5		33022	 3553563001				
	HL 7/50 DCGS-11.5		33021	 3553564401				
	HL 7/50 DCGS-11.5		32020X	 3553564401				
	HL 7/50 DCGS-11.5		33022	 3553563001				
	HL 7/50 DCS-11.5		33021	 3553564401				
	HL 7/50 DCS-11.5		32020X	 3553564401				
	HL 7/50 DCS-11.5		33022	 3553563001				
	HL 7/52 DS-11.5		33021	 3553564401				
	HL 7/52 DS-11.5		32020X	 3553564401				
	HL 7/52 DS-11.5		33022	 3553563001				
	NS 4.50 DC-10		33020					
	NS 4.50 DC-10		33116					
	NS 4/50 DCL-7.5		EK50031					
	NS 4/50 DCL-7.5		32312					
ACTROS 3300 SERIES								
	VL 4/50 DC-7.5	32314						
	VL 4/50 DC-7.5	32310						
	VL 4/50 DC-7.5	32312			 942 334 0801			
	VL 4/50 DC-7.5	EK50031			 942 334 0701			
	VL 4/50 DC-7.5	32312			 942 334 0701			
	VL 4/54 DC-8	32314						
	VL 4/54 DC-8	32310						

APPLICATION LISTINGS - TRUCK













A



MERCEDES-BENZ					
ACTROS 3300 SERIES ...					
	VL 4/54 DC-8	32312			942 334 0801
	VL 4/54 DC-8	EK50031			942 334 0701
	VL 4/54 DC-8	32312			942 334 0701
	VL 4/55 D-7.5	32314			
	VL 4/55 D-7.5	32310			
	VL 4/55 D-7.5	32312			942 334 0801
	VL 4/55 D-7.5	EK50031			942 334 0701
	VL 4/55 D-7.5	32312			942 334 0701
	VL 4/56 D-7.5	32314			
	VL 4/56 D-7.5	32310			
	VL 4/56 D-7.5	32312			942 334 0801
	VL 4/56 D-7.5	EK50031			942 334 0701
	VL 4/56 D-7.5	32312			942 334 0701
	VL 5/1 D-9	JH415647/10			
	VL 5/1 D-9	32311			
	VL 5/1 D-9	32311			
	VL 5/1 D-9	32311			
	VL 5/20 DC-9	32311			
	VL 5/20 DC-9	32311			
	VL 5/21 DC-9	32311			
	VL 5/21 DC-9	32311			
	HL 7/050 DCS-13		33021		3553564401
	HL 7/050 DCS-13		32020X		3553564401
	HL 7/050 DCS-13		33022		3553563001
	HL 7/052 DS-13		33021		3553564401
	HL 7/052 DS-13		32020X		3553564401
	HL 7/052 DS-13		33022		3553563001
	HL 7/50 DCS-16		33021		3553564401
	HL 7/50 DCS-16		32020X		3553564401
	HL 7/50 DCS-16		33022		3553563001
	HL 7/52 DS-11.5		33021		3553564401
	HL 7/52 DS-11.5		32020X		3553564401
	HL 7/52 DS-11.5		33022		3553563001
	HL 7/53 DS-16		33021		3553564401
	HL 7/53 DS-16		32020X		3553564401
	HL 7/53 DS-16		33022		3553563001
	NS 4.50 DC-10		33020		
	NS 4.50 DC-10		33116		
	NS 4/50 DCL-7.5		EK50031		
	NS 4/50 DCL-7.5		32312		
ACTROS 4100 SERIES					
	VL 4/27 D-7.5	32314			
	VL 4/27 D-7.5	32310			
	VL 4/27 D-7.5	32312			942 334 0801
	VL 4/27 D-7.5	EK50031			942 334 0701
	VL 4/27 D-7.5	32312			942 334 0701
	VL 4/53 DC-7.5	32314			
	VL 4/53 DC-7.5	32310			
	VL 4/53 DC-7.5	32312			942 334 0801
	VL 4/53 DC-7.5	EK50031			942 334 0701
	VL 4/53 DC-7.5	32312			942 334 0701
	VL 4/55 D-7.5	32314			
	VL 4/55 D-7.5	32310			





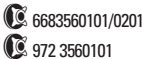





















































APPLICATION LISTINGS - TRUCK



					
MERCEDES-BENZ					
ACTROS 4100 SERIES ...					
	VL 4/55 D-7.5 VL 4/55 D-7.5 VL 4/55 D-7.5 VL 4/57 D-7.1 VL 4/57 D-7.1 VL 4/57 D-7.1 VL 4/57 D-7.1 VL 5/1 D-9 VL 5/1 D-9 VL 5/1 D-9 VL 5/1 D-9 HL 7/050 DCS-13 HL 7/050 DCS-13 HL 7/050 DCS-13 HL 7/052 DS-13 HL 7/052 DS-13 HL 7/052 DS-13 HL 7/53 DS-16 HL 7/53 DS-16 HL 7/53 DS-16 NS 4.50 DC-10 NS 4.50 DC-10 NS 4/50 DCL-7.5 NS 4/50 DCL-7.5	32312 EK50031 32312 EK50011 EK50031 32310 JH415647/10 32311 32311 32311	33021 32020X 33022 33021 32020X 33022 33021 32020X 33022 33020 33116 EK50031 32312		 942 334 0801 942 334 0701 942 334 0701 - 446052 -446053- 3553564401 3553564401 3553563001 3553564401 3553564401 3553563001 3553564401 3553564401 3553563001
ATEGO 700 SERIES					
	VL 2/21 DC-3.5 VL 2/21 DC-3.5 VL 2/21 DC-3.5 VL 2/21 DC-3.5 HL 2/43 DC-6.2	33111-90KA1 32306-9X025 33111-90KA1 32306-9X025	33011		 6683560101/0201
ATEGO 800 SERIES					
	VL 2/21 DC-3.5 VL 2/21 DC-3.5 VL 2/22 DC-4.1 VL 2/22 DC-4.1 HL 2/43 DC-6.2 HL 4/40 DC-7 HL 4/40 DC-7 HL 4/40 DC-7 HL 4/40 DC-7 HL 4/40 DC-7 HL 4/40 DC-7 HL 4/40 DC-7 HL 4/40 DC-7	33111-90KA1 32306-9X025 33111-90KA1 32306-9X025	33011 33017 33014 33020 33116 33019 32018X 580/572 39586/39528		 668 356 0101/0201 9723560101 9723560101 9763561101 6783560401 6783560401 6753560101 6753560101
ATEGO 900 SERIES					
	AL 3/40 D-4.7 VL 2/22 DC-4.1 VL 2/22 DC-4.1 VL 3/21 DC-5.3 VL 3/21 DC-5.3 HL 2/43 DC-6.2 HL 4/40 D-7	33017 33111-90KA1 32306-9X025 33213 33208-9TKA1	33011 33017		 6683560101/0201 972 3560101









APPLICATION LISTINGS - TRUCK



 		 			
MERCEDES-BENZ					
ATEGO 900 SERIES ...					
	HL 4/40 D-7		33014		 972 3560101
	HL 4/40 D-7		33020		 9763561101
	HL 4/40 D-7		33116		 9763561101
	HL 4/40 D-7		33019		 6783560401
	HL 4/40 D-7		32018X		 6783560401
	HL 4/40 D-7		580/572		 6753560101
	HL 4/40 D-7		39586/39528		 6753560101
	HL 4/40 DC-7		33017		 9723560101
	HL 4/40 DC-7		33014		 9723560101
	HL 4/40 DC-7		33020		 9763561101
	HL 4/40 DC-7		33116		 9763561101
	HL 4/40 DC-7		33019		 6783560401
	HL 4/40 DC-7		32018X		 6783560401
	HL 4/40 DC-7		580/572		 6753560101
	HL 4/40 DC-7		39586/39528		 6753560101
	HL 4/40 DS-7.7		33017		 972 3560101
	HL 4/40 DS-7.7		33014		 972 3560101
	HL 4/40 DS-7.7		33020		 9763561101
	HL 4/40 DS-7.7		33116		 9763561101
	HL 4/40 DS-7.7		33019		 6783560401
	HL 4/40 DS-7.7		32018X	 6783560401	
	HL 4/40 DS-7.7		580/572	 6753560101	
	HL 4/40 DS-7.7		39586/39528	 6753560101	
ATEGO 1000 SERIES					
	AL 3/40 D-4.7	33017			
	VL 2/22 DC-4.1	33111-90KA1			 668 356 0101/0201
	VL 2/22 DC-4.1	32306-9X025			 9723560101
	VL 3/21 DC-5.3	33213			 9723560101
	VL 3/21 DC-5.3	33208-9TKA1			 9763561101
	HL 2/43 DC-6.2		33011		 9763561101
	HL 4/40 D-7		33017		 6783560401
	HL 4/40 D-7		33014		 6783560401
	HL 4/40 D-7		33020		 6753560101
	HL 4/40 D-7		33116		 6753560101
	HL 4/40 D-7		33019		 9723560101
	HL 4/40 D-7		32018X		 9723560101
	HL 4/40 D-7		580/572		 9763561101
	HL 4/40 D-7		39586/39528		 9763561101
	HL 4/40 DC-7		33017		 9723560101
	HL 4/40 DC-7		33014		 9723560101
	HL 4/40 DC-7		33020		 9763561101
	HL 4/40 DC-7		33116		 9763561101
	HL 4/40 DC-7		33019		 6783560401
	HL 4/40 DC-7		32018X		 6783560401
	HL 4/40 DC-7		580/572		 6753560101
	HL 4/40 DC-7		39586/39528		 6753560101
	HL 4/40 DS-7.7		33017		 9723560101
	HL 4/40 DS-7.7		33014		 9723560101
	HL 4/40 DS-7.7		33020		 9763561101
	HL 4/40 DS-7.7		33116		 9763561101
	HL 4/40 DS-7.7		33019		 6783560401
	HL 4/40 DS-7.7		32018X		 6783560401
	HL 4/40 DS-7.7		580/572	6753560101	
	HL 4/40 DS-7.7		39586/39528	6753560101	

APPLICATION LISTINGS - TRUCK



















































							
MERCEDES-BENZ							
ATEGO 1200/1300/1500 SERIES							
	AL 3/40 D-6 AL 3/40 D-6 VL 3/21 DC-5.3 VL 3/21 DC-5.3 HL 4/40 DC-10.8 HL 4/40 DC-10.8 HL 4/40 DC-10.8 HL 4/40 DC-10.8 HL 4/40 DC-10.8 HL 4/40 DC-10.8 HL 4/40 DC-10.8 HL 4/40 DC-10.8 HL 4/40 DC-10.8	33020 32017X 33213 33208-9TKA1		33017 33014 33020 33116 33019 32018X 580/572 39586/39528		 9723560101 9723560101 9763561101 9763561101 6783560401 6783560401 6753560101 6753560101	
ATEGO 1800 SERIES							
	AL 7/52 D-9 AL 7/52 D-9 AL 7/52 D-7.5 AL 7/52 D-7.5 AL 7/52 DS-7.5 AL 7/52 DS-7.5 VL 4/50 DC-7.5 VL 4/50 DC-7.5 VL 4/50 DC-7.5 VL 4/50 DC-7.5 VL 4/51 DC-7.5 VL 4/51 DC-7.5 VL 4/51 DC-7.5 VL 4/51 DC-7.5 VL 4/51 DC-7.5 VL 4/51 DC-7.5 VL 4/51 DC-7.5 VL 4/54 DC-8 VL 4/54 DC-8 VL 4/54 DC-8 VL 4/55 D-7.5 VL 4/55 D-7.5 VL 4/55 D-7.5 VL 4/55 D-7.5 VL 4/55 D-7.5 VL 4/55 D-7.5 VL 4/56 D-7.5 VL 4/56 D-7.5 VL 4/56 D-7.5 VL 4/56 D-7.5 VL 4/56 D-7.5 VL 4/56 D-7.5 VL 4/56 D-7.5 VL 4/56 D-7.5 VL 4/57 D-7.1 VL 4/57 D-7.1 VL 4/57 D-7.1 VL 5/1 D-9 VL 5/1 D-9 VL 5/1 D-9 VL 5/1 D-9 VL 5/21 DC-9	XGA32021X/Y32021X 33019 33019-90KA1 XGA32021X-90KA1 XGA32021X/Y32021X 33019 32314 32310 32312 EK50031 32312 32314 32310 32312 EK50031 32312 32314 32310 32312 32314 32310 32312 32314 32310 32312 32314 32310 32312 EK50031 32312 32310 32314 32310 32312 EK50031 32312 EK50031 32312 EK50031 32312 EK50011 EK50031 32310 JH415647/10 32311 32311 32311 32311			 9423340801 9423340701 9423340701 9423340801 9423340701 9423340701 9423340801 9423340701 9423340701 9423340801 9423340701 9423340701 9423340801 9423340701 9423340701 9423340701 9423340701 9423340701 446052 446053-		



APPLICATION LISTINGS - TRUCK











				  						
MERCEDES-BENZ										
ATEGO 1800 SERIES ...										
	VL 5/21 DC-9	32311	33021				 3553564401			
	HL 7/50 DCS-11.5		32020X				 3553564401			
	HL 7/50 DCS-11.5		33022				 3553563001			
	HL 7/50 DCS-13		33021				 3553564401			
	HL 7/50 DCS-13		32020X				 3553564401			
	HL 7/50 DCS-13		33022				 3553563001			
	HL 7/52 DS-13		33021				 3553564401			
	HL 7/52 DS-13		32020X				 3553564401			
	HL 7/52 DS-13		33022				 3553563001			
	HL 8/1 DCS-13		33022							
	HL 8/1 DCS-13		HM220149/10							
	NS 4.50 DC-10		33020							
	NS 4.50 DC-10		33116							
	NS 4/50 DCL-7.5		EK50031							
	NS 4/50 DCL-7.5		32312							
ATEGO 2500 SERIES										
	VL 4/51 DC-7.5	32314								 9423340801
	VL 4/51 DC-7.5	32310								 9423340701
	VL 4/51 DC-7.5	32312		 9423340701						
	VL 4/51 DC-7.5	EK50031								
	VL 4/51 DC-7.5	32312		 9423340801						
	VL 4/52 DC-7.5	32314		 9423340801						
	VL 4/52 DC-7.5	32310		 9423340701						
	VL 4/52 DC-7.5	32312		 9423340701						
	VL 4/52 DC-7.5	EK50031								
	VL 4/52 DC-7.5	32312		 9423340801						
	VL 4/52 DC-7.5	32314		 9423340701						
	VL 4/53 DC-7.5	32310		 9423340801						
	VL 4/53 DC-7.5	32312		 9423340701						
	VL 4/53 DC-7.5	EK50031		 9423340701						
	VL 4/53 DC-7.5	32312		 9423340801						
	VL 4/53 DC-7.5	32314		 9423340701						
	VL 4/54 DC-8	32310		 9423340801						
	VL 4/54 DC-8	32312		 9423340701						
	VL 4/54 DC-8	EK50031		 9423340701						
	VL 4/54 DC-8	32312		 9423340801						
	VL 4/57 D-7.1	EK50011		 446052						
	VL 4/57 D-7.1	EK50031		 446053-						
	VL 4/57 D-7.1	32310								
	VL 5/21 DC-9	32311								
	VL 5/21 DC-9	32311								
	HL 7/052 DS-13		33021	 3553564401						
	HL 7/052 DS-13		32020X	 3553564401						
	HL 7/052 DS-13		33022	 3553563001						
	HL 7/50 DCS-11.5		33021	 3553564401						
	HL 7/50 DCS-11.5		32020X	 3553564401						
	HL 7/50 DCS-11.5		33022	 3553563001						
	HL 8/1 DCS-13		33022							
	HL 8/1 DCS-13		HM220149/10							
	NS 4.50 DC-10		33020							
	NS 4.50 DC-10		33116							
	NS 4/50 DCL-7.5		EK50031							
	NS 4/50 DCL-7.5		32312							







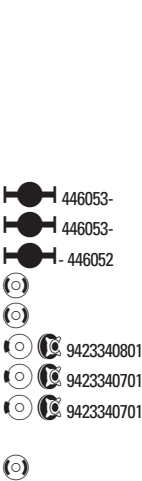





































APPLICATION LISTINGS - TRUCK



					
MERCEDES-BENZ					
ATEGO 2600 SERIES					
	VL 4/50 DC-7.5 VL 4/50 DC-7.5 VL 4/50 DC-7.5 VL 4/50 DC-7.5 VL 4/50 DC-7.5 VL 4/51 DC-7.5 VL 4/51 DC-7.5 VL 4/51 DC-7.5 VL 4/51 DC-7.5 VL 4/51 DC-7.5 VL 4/51 DC-7.5 VL 4/51 DC-7.5 VL 4/54 DC-8 VL 4/54 DC-8 VL 4/54 DC-8 VL 4/54 DC-8 VL 4/54 DC-8 VL 4/55 D-7.5 VL 4/55 D-7.5 VL 4/55 D-7.5 VL 4/56 D-7.5 VL 4/56 D-7.5 VL 4/56 D-7.5 VL 4/56 D-7.5 VL 4/56 D-7.5 HL 7/50 DC-11.5 HL 7/50 DC-11.5 HL 7/50 DC-11.5 HL 7/50 DCGS-11.5 HL 7/50 DCGS-11.5 HL 7/50 DCGS-11.5 HL 7/52 DS-11.5 HL 7/52 DS-11.5 HL 7/52 DS-11.5 NS 4.50 DC-10 NS 4.50 DC-10 NS 4/50 DCL-7.5 NS 4/50 DCL-7.5	32314 32310 32312 EK50031 32312 32314 32310 32312 EK50031 32312 32314 32310 32312 EK50031 32312 32314 32310 32312 EK50031 32312 33021 32020X 33022 33021 32020X 33022 33022 33021 32020X 33020 33116 EK50031 32312			
AXOR 1800 SERIES					
	AL 7/52 D-7.5 AL 7/52 D-7.5 AL 7/52 D-9 AL 7/52 D-9 AL 7/52 DS-7.5 AL 7/52 DS-7.5 VL 4/27 D-7.5 VL 4/27 D-7.5 VL 4/27 D-7.5 VL 4/50 DC-7.5 VL 4/50 DC-7.5 VL 4/50 DC-7.5 VL 4/50 DC-7.5 VL 4/50 DC-7.5 VL 4/51 DC-7.5	33019-90KA1 XGA32021X-90KA1 33019-90KA1 XGA32021X-90KA1 33019-90KA1 XGA32021X-90KA1 EK50031 32310 32310 32314 32310 32312 EK50031 32312 EK50031 32314			

APPLICATION LISTINGS - TRUCK

























					
MERCEDES-BENZ					
AXOR 1800 SERIES ...					
	HL 7/052 DS-13 HL 7/052 DS-13 HL 7/052 DS-13 HL 7/056 DS-13 HL 7/056 DS-13 HL 7/50 DC-11.5 HL 7/50 DC-11.5 HL 7/50 DC-11.5 HL 7/50 DCGS-11.5 HL 7/50 DCGS-11.5 HL 7/50 DCGS-11.5 HL 7/50 DCS-11.5 HL 7/50 DCS-11.5 HL 7/50 DCS-11.5 HL 7/50 DCS-13 HL 7/50 DCS-13 HL 7/50 DCS-13 HL 7/52 DS-11.5 HL 7/52 DS-11.5 HL 7/52 DS-11.5 HL 7/52 DS-13 HL 7/52 DS-13 HL 7/53 DS-16 HL 7/53 DS-16 HL 7/53 DS-16 HL 7/56 DS-13 HL 7/56 DS-13 HL 8/1 DCS-13 HL 8/1 DCS-13 NS 4.50 DC-10 NS 4.50 DC-10 NS 4/50 DCL-7.5 NS 4/50 DCL-7.5	33021 32020X 33022 33022 HM220149/10 33021 32020X 33022 33021 32020X 33022 33021 32020X 33022 33021 32020X 33022 33021 32020X 33022 33021 32020X 33022 33021 32020X 33022 33021 32020X 33022 HM220149/10 33021 32020X 33022 33022 HM220149/10 33022 HM220149/10 33020 33116 EK50031 32312		 3553564401  3553564401  3553563001  3553564401  3553564401  3553563001  3553564401  3553564401  3553563001  3553564401  3553564401  3553563001  3553564401  3553563001  3553564401  3553564401  3553563001  3553564401  3553564401  3553563001  3553564401  3553564401  3553563001	
AXOR 2500 SERIES					
	AL 7/52 D-7.5 AL 7/52 D-7.5 AL 7/52 D-9 AL 7/52 D-9 AL 7/52 DS-7.5 AL 7/52 DS-7.5 VL 4/27 D-7.5 VL 4/27 D-7.5 VL 4/27 D-7.5 VL 4/50 DC-7.5 VL 4/51 DC-7.5 VL 4/54 DC-8 VL 4/55 D-7.5 VL 4/56 D-7.5 VL 4/56 D-7.5 VL 4/56 D-7.5 VL 4/57 D-7.1 VL 4/57 D-7.1 VL 4/57 D-7.1	33019-90KA1 XGA32021X-90KA1 33019-90KA1 XGA32021X-90KA1 33019-90KA1 XGA32021X-90KA1 EK50031 32310 32310 EK50031 EK50031 EK50031 32310 32310 EK50031 32310 32310 EK50011 32310 32310 EK50031		 446053-  446053-  - 446052  9423340701, 9493340501  9423340701, 9493340501  446053-  - 446052  446053-  446053-  - 446052  - 446052  446053-	

APPLICATION LISTINGS - TRUCK









A



 		 			
MERCEDES-BENZ					
AXOR 2500 SERIES ...					
VL 4/57 D-7.1 VL 5/1 D-9 VL 5/1 D-9 VL 5/21 DC-9 VL 5/21 DC-9 HL 6/1 DC-13 HL 6/1 DC-13 HL 6/3 DC-13 HL 6/3 DC-13 HL 7/056 DS-13 HL 7/056 DS-13 HL 7/52 DS-13 HL 7/52 DS-13 HL 7/56 DS-13 HL 7/56 DS-13 HL 8/1 DCS-13 HL 8/1 DCS-13 NS 4/50 DCL-7.5	32310 33217-90KA1 32311 33217-90KA1 32311	33022 HM220149/10 33022 HM220149/10 33022 HM220149/10 33022 HM220149/10 33022 HM220149/10 33022 HM220149/10 EK50031		 446053-	
AXOR 2600 SERIES					
AL 7/52 D-7.5 AL 7/52 D-7.5 AL 7/52 D-9 AL 7/52 D-9 AL 7/52 DS-7.5 AL 7/52 DS-7.5 VL 4/27 D-7.5 VL 4/27 D-7.5 VL 4/27 D-7.5 VL 4/50 DC-7.5 VL 4/51 DC-7.5 VL 4/54 DC-8 VL 4/55 D-7.5 VL 4/56 D-7.5 VL 4/56 D-7.5 VL 4/56 D-7.5 VL 4/57 D-7.1 VL 4/57 D-7.1 VL 4/57 D-7.1 VL 4/57 D-7.1 VL 5/1 D-9 VL 5/1 D-9 VL 5/21 DC-9 VL 5/21 DC-9 HL 6/1 DC-13 HL 6/1 DC-13 HL 6/3 DC-13 HL 6/3 DC-13 HL 7/056 DS-13 HL 7/056 DS-13 HL 7/52 DS-13 HL 7/52 DS-13 HL 7/56 DS-13 HL 7/56 DS-13	33019-90KA1 XGA32021X-90KA1 33019-90KA1 XGA32021X-90KA1 33019-90KA1 XGA32021X-90KA1 EK50031 32310 32310 EK50031 EK50031 EK50031 32310 32310 EK50031 32310 EK50011 32310 EK50031 32310 33217-90KA1 32311 33217-90KA1 32311	33022 HM220149/10 33022 HM220149/10 33022 HM220149/10 33022 HM220149/10 33022 HM220149/10		 446053-  446053-  - 446052  9423340701, 9493340501  9423340701, 9493340501  446053-  - 446052  446053-  446053-  - 446052  - 446052  446053-  446053-	

APPLICATION LISTINGS - TRUCK



					
MERCEDES-BENZ					
AXOR 2600 SERIES ...					
	HL 8/1 DCS-13 HL 8/1 DCS-13 NS 4/50 DCL-7.5		33022 HM220149/10 EK50031		
AXOR 3200 SERIES					
	AL 7/52 D-7.5 AL 7/52 D-7.5 AL 7/52 D-9 AL 7/52 D-9 AL 7/52 DS-7.5 AL 7/52 DS-7.5 VL 4/27 D-7.5 VL 4/27 D-7.5 VL 4/27 D-7.5 VL 4/50 DC-7.5 VL 4/51 DC-7.5 VL 4/54 DC-8 VL 4/55 D-7.5 VL 4/56 D-7.5 VL 4/56 D-7.5 VL 4/56 D-7.5 VL 4/57 D-7.1 VL 4/57 D-7.1 VL 4/57 D-7.1 VL 4/57 D-7.1 VL 5/1 D-9 VL 5/1 D-9 VL 5/21 DC-9 VL 5/21 DC-9 HL 6/1 DC-13 HL 6/1 DC-13 HL 6/3 DC-13 HL 6/3 DC-13 HL 7/056 DS-13 HL 7/056 DS-13 HL 7/52 DS-13 HL 7/52 DS-13 HL 7/56 DS-13 HL 7/56 DS-13 HL 8/1 DCS-13 HL 8/1 DCS-13 NS 4/50 DCL-7.5	33019-90KA1 XGA32021X-90KA1 33019-90KA1 XGA32021X-90KA1 33019-90KA1 XGA32021X-90KA1 EK50031 32310 32310 EK50031 EK50031 EK50031 32310 EK50031 32310 32310 EK50011 32310 EK50031 32310 33217-90KA1 32311 33217-90KA1 32311	33022 HM220149/10 33022 HM220149/10 33022 HM220149/10 33022 HM220149/10 33022 HM220149/10 33022 HM220149/10 33022 HM220149/10 EK50031		446053- 446053- 446052 9423340701, 9493340501 9423340701, 9493340501 446053- 446053- 446053- 446052 446052 446052 446053- 446053-
LK 700 SERIES					
	VL 1/10 C-2.5 VL 1/10 C-2.5 VL 1/8 D-2.5 VL 1/8 D-2.5 VL 1/9 C-2.3 VL 1/9 C-2.3 VL 2/5-2.2 VL 2/5-2.2 HL 1/8-4.7 HL 1/8-4.7	33109 33205 33109 33205 33109 33205 32011X 32206	32014X 32011X		

APPLICATION LISTINGS - TRUCK









A



MERCEDES-BENZ					
LK 700 SERIES ...					
	HL 1/9-5.6 HL 2/12 D-4.5 HL 2/12 D-4.5 HL 2/13 D-6.4 HL 2/15-5.8 HL 2/2 L-4.8 HL 2/2 L-4.8 HL 2/2-4.8 HL 2/2-4.8		33011 32014X 32011X JM714249/10 33011 3984/3920 33895/33822 3984/3920 33895/33822		
LK 800 SERIES					
	VL 1/10 C-2.5 VL 1/10 C-2.5 VL 2/10 D-3.5 VL 2/10 D-3.5 VL 2/12 D-3.8 VL 2/12 D-3.8 VL 2/4-3.4 VL 2/4-3.4 VL 2/6-3.1 VL 2/6-3.1 VL 2/8-3.2 VL 2/8-3.2 VL 2/9 D-3.1 VL 2/9 D-3.1 VL 3/11 D-4.4 VL 3/11 D-4.4 HL 1/9-5.6 HL 2/11 D-5.8 HL 2/12 D-4.5 HL 2/12 D-4.5 HL 2/13 D-6.4 HL 2/15 S-5.8 HL 2/15-5.8 HL 2/3-5.7 HL 2/3-5.7 HL 2/4 L-6.4 HL 2/4-6.4 HL 4/1-7.6 HL 4/1-7.6 HL 4/23-7.7 HL 4/23-7.7 HL 4/28 D-7.8 HL 4/28 D-7.8 HL 4/29 D-9.2 HL 4/30 D-6.4 HL 4/30 DS-6.4 HL 4/35 D-6.4 HL 4/4-8.8	33109 33205 33211 32306 33211 EK50029 33111 32306 33111 32306 33211 32306 33111 32306 33213 33208	33011 33011 32014X 32011X JM714249/10 33011 33011 47490/47420 33111 JM714249/10 JM714249/10 32216 39586/39528 580/572 39586/39528 580/572 39586/39528 33117 32016X 32016X 32016X 32217		
LK 900 SERIES					
	VL 2/10 D-3.5 VL 2/10 D-3.5 VL 2/10 D-3.5	33211 32306 33211			

















APPLICATION LISTINGS - TRUCK



					
MERCEDES-BENZ					
LK 900 SERIES ...					
	VL 2/10 D-3.5 VL 2/11 D-3.8 VL 2/11 D-3.8 VL 2/12 D-3.8 VL 2/12 D-3.8 VL 2/4-3.4 VL 2/4-3.4 VL 2/6-3.1 VL 2/6-3.1 VL 3/11 D-4.4 VL 3/11 D-4.4 VL 3/1-8.8 VL 3/1-8.8 HL 2/13 D-6.4 HL 2/4 L-6.4 HL 2/4-6.4 HL 4/1-7.6 HL 4/1-7.6 HL 4/23 L-7.7 HL 4/23 L-7.7 HL 4/28 D-7.8 HL 4/28 D-7.8 HL 4/29 D-9.2 HL 4/30 D-6.4 HL 4/30 DS-6.4 HL 4/31 DS-7.0 HL 4/35 D-6.4 HL 4/4-8.8	32306 33211 EK50029 33211 EK50029 33111 32306 33111 32306 33213 33208 EK50036 EK50029	JM714249/10 JM714249/10 JM714249/10 32216 39586/39528 580/572 39586/39528 580/572 39586/39528 33117 32016X 32016X 33117 32016X 32217		
LK 1000 SERIES					
	VL 2/6-3.1 VL 2/6-3.1 VL 2/7-3.6 VL 2/7-3.6 VL 3/1-3.8 VL 3/1-3.8 VL 3/4 -5 VL 3/4 -5 VL 3/6-4.1 VL 3/6-4.1 VL 3/7 -5 VL 3/7 -5 HL 2/4 L-6.4 HL 2/7-7.7 HL 2/7-7.7 HL 4/01 L-10 HL 4/01 L-10 HL 4/01-10 HL 4/01-10 HL 4/16 L-7.7 HL 4/16 L-7.7 HL 4/16-7.7 HL 4/16-7.7 HL 4/17 L-9.2	33111 32306 33211 32306 EK50036 EK50029 EK50036 EK50029 33213 33208 33213 33208	JM714249/10 580/572 39586/39528 33020 33117 33020 33117 580/572 39586/39528 580/572 39586/39528 32217		







APPLICATION LISTINGS - TRUCK

















 		 				
MERCEDES-BENZ						
LK 1000 SERIES ...						
	HL 4/17 S-9.2		32217			
	HL 4/1-7.6		32216			
	HL 4/1-7.6		39586/39528			
	HL 4/17-9.2		32217			
	HL 4/23 L-7.7		580/572			
	HL 4/23 L-7.7		39586/39528			
	HL 4/23-7.7		580/572			
	HL 4/23-7.7		39586/39528			
	HL 4/4-8.8		32217			
	HL 4/8 L-10		33019			
	HL 4/8 L-10		33215			
	HL 4/8-6.3		33019			
	HL 4/8-6.3		33215			
	HL 7/1 S -10		33021		 - 021298	
	HL 7/1 S -10		32019X		 - 021298	
	HL 7/1 S-10		EK50021		 021299-	
	HL 7/1 S-10		32019X		 021299-	
	HL 7/1-10		33021		 - 021298	
	HL 7/1-10		32019X	 - 021298		
	HL 7/1-10		EK50021	 021299-		
	HL 7/1-10		32019X	 021299-		
LK 1100 SERIES						
	VL 2/11 D-3.8	33211				
	VL 2/11 D-3.8	EK50029				
	VL 2/8-3.2	33211				
	VL 2/8-3.2	32306				
	VL 3/11 D-4.4	33213				
	VL 3/11 D-4.4	33208				
	VL 3/13 D-5.3	33214				
	VL 3/13 D-5.3	33209				
	HL 4/05 D-9.2		33019			
	HL 4/05 D-9.2		33215			
	HL 4/09 D-9.2		33019			
	HL 4/09 D-9.2		33215			
	HL 4/1-7.6		32216			
	HL 4/1-7.6		39586/39528			
	HL 4/23 L-7.7		580/572			
	HL 4/23 L-7.7		39586/39528			
	HL 4/23-7.7		580/572			
	HL 4/23-7.7		39586/39528			
	HL 4/28 D-7.8		580/572			
	HL 4/28 D-7.8		39586/39528			
	HL 4/29 D-9.2		33117			
	HL 4/31 DS-7.0		33117			
	HL 4/4-8.8		32217			
	HL 5/2 S-6.5		33019			
	HL 5/2 S-6.5		33215			
LK 1200 SERIES						
	VL 3/6 D-4.1	33213				
	VL 3/6 D-4.1	33208				
	VL 3/6-4.1	33213				
	VL 3/6-4.1	33208				

APPLICATION LISTINGS - TRUCK



		 		
MERCEDES-BENZ				
LK 1200 SERIES ...				
VL 3/7 D-5	33213			
VL 3/7 D-5	33208			
VL 3/7-5	33213			
VL 3/7-5	33208			
VL 3/8-6	33214			
VL 3/8-6	33209			
VL 3/8-6	33214			
VL 3/8-6	33210			
VL 4/3-6	33214			
VL 4/3-6	33209			
HL 4/01 L-10		33020		
HL 4/01 L-10		33117		
HL 4/01-10		33020		
HL 4/01-10		33117		
HL 4/038 D-10		33020		
HL 4/038 D-10		33117		
HL 4/038 D-9.4		33020		
HL 4/038 D-9.4		33117		
HL 4/039 D-10		33020		
HL 4/039 D-10		33117		
HL 4/07 D-9.4		33020		
HL 4/07 D-9.4		33117		
HL 4/16 L-7.7		580/572		
HL 4/16 L-7.7		39586/39528		
HL 4/16-7.7		580/572		
HL 4/16-7.7		39586/39528		
HL 4/17 D-9.2		32217		
HL 4/17 L-9.2		32217		
HL 4/17-9.2		32217		
HL 4/29 D-9.2		33117		
HL 4/4-8.8		32217		
HL 4/8 L-10		33019		
HL 4/8 L-10		33215		
HL 4/8-10		33019		
HL 4/8-10		33215		
HL 5/1 Z-10		598/592A		
HL 5/1 Z-10		32215		
HL 7/024 D-12.3		33021		
HL 7/024 D-12.3		33019		
HL 7/1 D-10		33021		
HL 7/1 D-10		32019X		
HL 7/1 D-10		EK50021		
HL 7/1 D-10		32019X		
HL 7/1 L-10		33021		
HL 7/1 L-10		32019X		
HL 7/1 L-10		EK50021		
HL 7/1 L-10		32019X		
HL 7/1 S-10		33021		
HL 7/1 S-10		32019X		
HL 7/1 S-10		EK50021		
HL 7/1 S-10		32019X		
HL 7/1-10		33021		
HL 7/1-10		32019X		
HL 7/1-10		EK50021		







-  - 1358880
-  - 1358880
-  - 1358881 -
-  - 1358881 -

-  - 021298
-  - 021298
-  - 021299-
-  - 021299-
-  - 021298
-  - 021298
-  - 021299-
-  - 021299-
-  - 021298
-  - 021298
-  - 021299-
-  - 021299-
-  - 021298
-  - 021298

APPLICATION LISTINGS - TRUCK







A



     	
MERCEDES-BENZ	
LK 1200 SERIES ...	
HL 7/1-10 HL 7/18 D-13 HL 7/18 D-13 HL 7/18 D-13 HL 7/18 D-13 HL 7/18 D-13 HL 7/26 DL-12.3 HL 7/26 DL-12.3	32019X 33022 30220 33022 30220 33021 33019
LK 1300 SERIES	
AL 7/1 D-7 AL 7/1 D-7 VL 2/10 D-3.5 VL 2/10 D-3.5 VL 2/12 D-3.8 VL 2/12 D-3.8 VL 3/11 D-4.4 VL 3/11 D-4.4 VL 3/12 D-5.3 VL 3/12 D-5.3 VL 3/12 D-5.3 VL 3/13 D-5.3 VL 3/13 D-5.3 VL 4/23 D-6.7 VL 4/23 D-6.7 VL 4/3-6 VL 4/3-6 HL 1/8-4.7 HL 1/8-4.7 HL 4/05 D-9.2 HL 4/05 D-9.2 HL 4/29 D-9.2 HL 4/32 D-10.6 HL 4/32 D-10.6 HL 4/4-8.8 HL 4/8-10 HL 4/8-10 HL 5/1 Z-10 HL 5/1 Z-10	XGA32021X/Y32021X 32019X 33211 32306 33211 EK50029 33213 33208 33213 33208 33214 33209 EK50011 32310 33214 33209 32014X 32011X 33019 33215 33117 33019 33215 32217 33019 33215 598/592A 32215
LK 1400 SERIES	
VL 3/15 D-6.5 VL 3/15 D-6.5 VL 3/7 D-5 VL 3/7 D-5 VL 3/7-5 VL 3/7-5 VL 3/8 D-6.5 VL 3/8 D-6.5 VL 3/8-6 VL 3/8-6 VL 3/8-6 VL 3/8-6 VL 4/10 D-7 VL 4/10 D-7 VL 4/10 DL-7	33214 33210 33213 33208 33213 33208 33214 33210 33214 33209 33214 33210 EK50011 33210 EK50011

APPLICATION LISTINGS - TRUCK



     		
MERCEDES-BENZ LK 1400 SERIES ...		
VL 4/10 DL-7	33210	
VL 4/24 D-6.7	EK50011	
VL 4/24 D-6.7	33210	
VL 4/25 DL-6.7	EK50011	
VL 4/25 DL-6.7	33210	
VL 4/25 DL-7.1	EK50011	
VL 4/25 DL-7.1	33210	
VL 4/29 D-7.5	32314	
VL 4/29 D-7.5	32310	
VL 4/30 DL-7.5	32314	
VL 4/30 DL-7.5	32310	
VL 4/3-6	33214	
VL 4/3-6	33209	
VL 4/36 D-6.7	EK50011	
VL 4/36 D-6.7	32310	
VL 4/36 D-7.1	EK50011	
VL 4/36 D-7.1	32310	
HH 4/19 D-10		33019
HH 4/19 D-10		33215
HL 4/01 D-10		33020
HL 4/01 D-10		33117
HL 4/01 DL-10		33020
HL 4/01 DL-10		33117
HL 4/01 L-10		33020
HL 4/01 L-10		33117
HL 4/01-10		33020
HL 4/01-10		33117
HL 4/038 D-10		33020
HL 4/038 D-10		33117
HL 4/039 D-10		33020
HL 4/039 D-10		33117
HL 4/17 D-9.2		32217
HL 4/17-9.2		32217
HL 4/8 D-10		33019
HL 4/8 D-10		33215
HL 4/8-10		33019
HL 4/8-10		33215
HL 5/2 Z-10		33019
HL 5/2 Z-10		33215
HL 5/2-10		33019
HL 5/2-10		33215
HL 7/021 D-10		33021
HL 7/021 D-10		32019X
HL 7/021 D-10		EK50021
HL 7/021 D-10		32019X
HL 7/021 DL-10		33021
HL 7/021 DL-10		32019X
HL 7/021 DL-10		EK50021
HL 7/021 DL-10		32019X
HL 7/024 D-12.3		33021
HL 7/024 D-12.3		32019X
HL 7/024 DL-12.3		33021
HL 7/024 DL-12.3		32019X
HL 7/1 L-10		33021

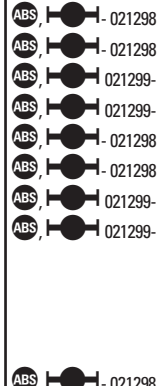

APPLICATION LISTINGS - TRUCK







A

















MERCEDES-BENZ					
LK 1400 SERIES ...					
	HL 7/1 L-10 HL 7/1 D-10 HL 7/1 D-10 HL 7/1 D-10 HL 7/1 D-10 HL 7/1 DL-10 HL 7/1 DL-10 HL 7/1 DL-10 HL 7/1 DL-10 HL 7/1 DL-10 HL 7/1-10 HL 7/1-10 NS 4/10 D-6.7 NS 4/10 D-6.7		32019X 33021 32019X EK50021 32019X 33021 32019X EK50021 32019X 33021 32019X EK50011 33210		ABS - 021298 ABS - 021298 ABS - 021298 ABS - 021299- ABS - 021299- ABS - 021298 ABS - 021298 ABS - 021299- ABS - 021299- ABS - 021298 ABS - 021298 ABS - 021299- ABS - 021298
LK 1500 SERIES					
	VL 3/13 D-5.3 VL 3/13 D-5.3 VL 4/3-6 VL 4/3-6 VL 3/15 D-6.5 VL 3/15 D-6.5 HL 4/035 D-10.6 HL 4/035 D-10.6 HL 4/06 D-12 HL 4/06 D-12 HL 4/32 D-10.6 HL 4/32 D-10.6 HL 4/8-10 HL 4/8-10 HL 5/2 S-10 HL 5/2 S-10 HL 5/2 ZS-10 HL 5/2 ZS-10 HL 5/2-10 HL 5/2-10	33214 33209 33214 33209 33214 33210	33020 33117 33020 33117 33019 33215 33019 33215 33019 33215 33019 33215 33019 33215		
SK 1600 SERIES					
	AL 7/1 D-7 AL 7/1 D-7 VD 4/14 DL-7 VD 4/14 DL-7 VD 4/20 DL-7.5 VD 4/20 DL-7.5 VD 4/20 DL-7.5 VD 4/20 DL-7.5 VL 3/8 D-6.5 VL 3/8 D-6.5 VL 3/8-6 VL 3/8-6 VL 3/8-6 VL 3/8-6 VL 4/10 D-7 VL 4/10 D-7 VL 4/10 D-7	XGA32021X/Y32021X 32019X EK50011 32310 EK50011 33210 32314 32310 33214 33210 33214 33209 33214 33210 EK50011 33210 EK50011			- 1358880 - 1358880 1358881 - 1358881 -

APPLICATION LISTINGS - TRUCK



		 		
MERCEDES-BENZ				
SK 1600 SERIES ...				
VL 4/10 D-7		32310		
VL 4/10 DL-7		EK50011		
VL 4/10 DL-7		33210		
VL 4/15 D-7.5		32314		
VL 4/15 D-7.5		32310		
VL 4/16 D-7.5		32314		
VL 4/16 D-7.5		32310		
VL 4/18 D L-7		EK50011		
VL 4/18 D L-7		32310		
VL 4/19 D-7.5		32314		
VL 4/19 D-7.5		32310		
VL 4/2 D-7		30314		
VL 4/2 D-7		32310		
VL 4/30 DL-7.5		32314		
VL 4/30 DL-7.5		32310		
VL 4/7 D-7		EK50011		
VL 4/7 D-7		33210		
VL 4/7 D-7		EK50011		
VL 4/7 D-7		32310		
VL 4/7 D-7		EK50011		
VL 4/7 D-7		32310		
VL 4/7 D-7		EK50011		
VL 4/7 D-7		33210		
VL 4/8 D-7		EK50011		
VL 4/8 D-7		33210		
VL 4/9 D-7		EK50011		
VL 4/9 D-7		33210		
VL 4/9 D-7		EK50011		
VL 4/9 D-7		32310		
HD 7/2 DLG-10			EK50021	
HH 4/04 D-12			33020	
HH 4/04 D-12			33117	
HL 4/01 D L-10			33020	
HL 4/01 D L-10			33117	
HL 4/01 D-10			33020	
HL 4/01 D-10			33117	
HL 4/01 L-10			33020	
HL 4/01 L-10			33117	
HL 4/01-10			33020	
HL 4/01-10			33117	
HL 4/06 D L-12			33020	
HL 4/06 D L-12			33117	
HL 4/06 D-12			33020	
HL 4/06 D-12			33117	
HL 4/8 D-10			33019	
HL 4/8 D-10			33215	
HL 4/8 L-10			33019	
HL 4/8 L-10			33215	
HL 4/8-10			33019	
HL 4/8-10			33215	
HL 5/2 Z-10			33019	
HL 5/2 Z-10			33215	
HL 5/2 ZL-10			33019	
HL 5/2 ZL-10			33215	





























































-  - 1278813
-  - 1278813
-  1278814 -
-  1278814 -
-  - 724723
-  - 724723
-  724724 -
-  724724 -

-  - 1278813
-  - 1278813
-  1278814 -
-  1278814 -
-  ABS,  021299-





APPLICATION LISTINGS - TRUCK

A



 		 			
MERCEDES-BENZ					
SK 1600 SERIES ...					
	HL 5/2-10		33019		- 021298
	HL 5/2-10		33215		- 021298
	HL 7/013 D-16		33022		- 021299-
	HL 7/015 D-13		33022		- 021299-
	HL 7/015 D-13		30220		- 021298
	HL 7/015 D-13		33022		- 021298
	HL 7/015 D-13		30220		- 021298
	HL 7/015 DL-13		33022		- 021299-
	HL 7/015 DL-13		30220		- 021299-
	HL 7/015 DL-13		33022		- 021298
	HL 7/015 DL-13		30220		- 021298
	HL 7/015 DS-13		33022		- 021299-
	HL 7/015 DS-13		30220		- 021299-
	HL 7/015 DS-13		33022		- 021299-
	HL 7/015 DS-13		30220		- 021298
	HL 7/02 DL-10		33021		- 021298
	HL 7/02 DL-10		32019X		- 021299-
	HL 7/02 DL-10		EK50021		- 021299-
	HL 7/02 DL-10		32019X		- 021298
	HL 7/021 D-10		33021		- 021298
	HL 7/021 D-10		32019X		- 021298
	HL 7/021 D-10		EK50021		- 021299-
	HL 7/021 D-10		32019X		- 021298
	HL 7/021 DL-10		33021		- 021298
	HL 7/021 DL-10		32019X		- 021299-
	HL 7/021 DL-10		EK50021		- 021299-
	HL 7/021 DL-10		32019X		- 021299-
	HL 7/024 DL-12.3		33021		- 021298
	HL 7/024 DL-12.3		32019X		- 021298
	HL 7/024 DL-12.3		EK50021		- 021299-
	HL 7/024 DL-12.3		32019X		- 021299-
	HL 7/07 D-10		33021		- 021298
	HL 7/07 D-10		32019X		- 021298
	HL 7/07 D-10		EK50021		- 021299-
	HL 7/07 D-10		32019X		- 021299-
	HL 7/07 D-11.5		33021		- 021298
	HL 7/07 D-11.5		32019X		- 021298
	HL 7/07 D-11.5		EK50021		- 021299-
	HL 7/07 D-11.5		32019X		- 021299-
	HL 7/07 DL-10		33021		- 021298
	HL 7/07 DL-10		32019X		- 021298
	HL 7/07 DL-10		EK50021		- 021299-
	HL 7/07 DL-10		32019X		- 021299-
	HL 7/07 DL-11.5		33021		- 021298
	HL 7/07 DL-11.5		32019X		- 021298
	HL 7/07 DL-11.5		EK50021		- 021299-
	HL 7/07 DL-11.5		32019X		- 021299-
	HL 7/07 DS-10		33021		- 021298
	HL 7/07 DS-10		32019X		- 021298
	HL 7/07 DS-10		EK50021		- 021299-
	HL 7/07 DS-10		32019X		- 021299-
	HL 7/1 D -10		33021		- 021298
	HL 7/1 D -10		32019X		- 021298
	HL 7/1 D-10		EK50021		- 021299-







APPLICATION LISTINGS - TRUCK

					
MERCEDES-BENZ					
SK 1600 SERIES ...					
	HL 7/1 D-10		32019X		021299-
	HL 7/1 DL-10		33021		021298
	HL 7/1 DL-10		32019X		021298
	HL 7/1 DL-10		EK50021		021299-
	HL 7/1 DL-10		32019X		021299-
	HL 7/1 L-10		33021		021298
	HL 7/1 L-10		32019X		021298
	HL 7/1 L-10		EK50021		021299-
	HL 7/1 L-10		32019X		021299-
	HL 7/1 S-10		33021		021298
	HL 7/1 S-10		32019X		021298
	HL 7/1 S-10		EK50021		021299-
	HL 7/1 S-10		32019X		021299-
	HL 7/1-10		33021		021298
	HL 7/1-10		32019X		021298
	HL 7/1-10		EK50021		021299-
	HL 7/1-10		32019X		021299-
	HL 7/15 D-13		33021		021298
	HL 7/15 D-13		32019X		021298
	HL 7/15 D-13		EK50021		021299-
	HL 7/15 D-13		32019X	021299-	
	HL 7/18 D-13		33021	021298	
	HL 7/18 D-13		32019X	021298	
	HL 7/18 D-13		EK50021	021299-	
	HL 7/18 D-13		32019X	021299-	
	HL 7/2 DLG-10		33020		
	HL 7/2 DLG-10		33117		
	HL 7/21 D-10		33021	021298	
	HL 7/21 D-10		32019X	021298	
	HL 7/21 D-10		EK50021	021299-	
	HL 7/21 D-10		32019X	021299-	
	HL 7/3 D-10		33021	021298	
	HL 7/3 D-10		32019X	021298	
	HL 7/3 D-10		EK50021	021299-	
	HL 7/3 D-10		32019X	021299-	
	HL 7/3 DL-10		33021	021298	
	HL 7/3 DL-10		32019X	021298	
	HL 7/3 DL-10		EK50021	021299-	
	HL 7/3 DL-10		32019X	021299-	
SK 1700 SERIES					
	AL 7/1 D-7	XGA32021X/Y32021X			
	AL 7/1 D-7	32019X			
	VD 4/20 DL-7.5	32314			
	VD 4/20 DL-7.5	32310			
	VD 4/26 DL-7.5	32314			
	VD 4/26 DL-7.5	32310			
	VL 3/15 D-6.5	33214			
	VL 3/15 D-6.5	33210			
	VL 4/10 D-7	EK50011			
	VL 4/10 D-7	33210			
	VL 4/10 D-7	EK50011			
	VL 4/10 D-7	32310			
	VL 4/10 DL-7	EK50011			



APPLICATION LISTINGS - TRUCK





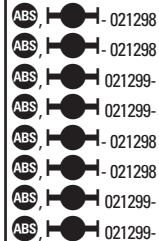
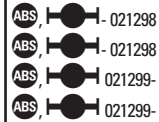





 		 			
MERCEDES-BENZ					
SK 1700 SERIES ...					
VL 4/10 DL-7	33210				
VL 4/16 D-7.5	32314				
VL 4/16 D-7.5	32310				
VL 4/23 D-6.7	EK50011				
VL 4/23 D-6.7	32310				
VL 4/24 D-6.7	EK50011				
VL 4/24 D-6.7	32310				
VL 4/24 D-7.1	EK50011				
VL 4/24 D-7.1	32310				
VL 4/25 DL-6.7	EK50011				
VL 4/25 DL-6.7	32310				
VL 4/27 D-7.5	32314				
VL 4/27 D-7.5	32310				
VL 4/28 D-7.5	32314				
VL 4/28 D-7.5	32310				
VL 4/29 D-7.5	32314				
VL 4/29 D-7.5	32310				
VL 4/30 DL-7.5	32314				
VL 4/30 DL-7.5	32310				
VL 4/31 DL-7.5	EK50011				
VL 4/31 DL-7.5	32310				
VL 4/31 DL-7.5	32314				
VL 4/31 DL-7.5	32310				
VL 4/8 D-7	EK50011				
VL 4/8 D-7	33210				
VL 5/2 D-9	JH415647/10				
VL 5/2 D-9	32311				
HD 7/016 DG-13		33022			
HD 7/016 DG-13		30220			
HD 7/016 DG-13		33022			
HD 7/016 DG-13		30220			
HL 4/038 D-12		33020			
HL 4/038 D-12		33117			
HL 4/039 D-12		33020			
HL 4/039 D-12		33117			
HL 4/06 D-12		33020			
HL 4/06 D-12		33117			
HL 4/06 DL-12		33020			
HL 4/06 DL-12		33117			
HL 7/013 D-16		33022			
HL 7/015 D-13		33022			
HL 7/015 D-13		30220			
HL 7/015 D-13		33022			
HL 7/015 D-13		30220			
HL 7/015 DL-13		33022			
HL 7/015 DL-13		30220			
HL 7/015 DL-13		33022			
HL 7/015 DL-13		30220			
HL 7/024 D-12.3		33021			
HL 7/024 D-12.3		33019			
HL 7/024 DL-12.3		33021			
HL 7/024 DL-12.3		33019			
HL 7/025 D-12.3		33021			
HL 7/025 D-12.3		33019			





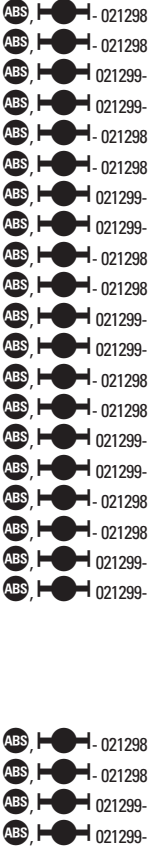



APPLICATION LISTINGS - TRUCK

























































					
MERCEDES-BENZ					
SK 1700 SERIES ...					
	HL 7/07 D-10 HL 7/07 D-10 HL 7/07 D-10 HL 7/07 D-10 HL 7/07 D-11.5 HL 7/07 D-11.5 HL 7/07 D-11.5 HL 7/07 D-11.5 HL 7/07 D-11.5 HL 7/07 DL-10 HL 7/07 DL-10 HL 7/07 DL-10 HL 7/07 DL-10 HL 7/07 DL-11.5 HL 7/07 DL-11.5 HL 7/07 DL-11.5 HL 7/07 DL-11.5 HL 7/18 D-13 HL 7/18 D-13 HL 7/18 D-13 HL 7/18 D-13 HL 7/26 D-12.3 HL 7/26 D-12.3 HL 7/26 DL-12.3 HL 7/26 DL-12.3 HL 7/3 D-10 HL 7/3 D-10 HL 7/3 D-10 HL 7/3 D-10	33021 32019X EK50021 32019X 33021 32019X EK50021 32019X 33021 32019X EK50021 32019X 33021 32019X EK50021 32019X 33022 30220 33022 30220 33021 33019 33021 33019 33021 32019X EK50021 32019X			
SK 1800 SERIES					
	AL 7/1 D-7 AL 7/1 D-7 AL 7/1 D-7.637 AL 7/1 D-7.637 AL 7/1 D-7/5.217 AL 7/1 D-7/5.217 VL 3/15 D-6.5 VL 3/15 D-6.5 VL 4/10 D-7 VL 4/10 D-7 VL 4/16 D-7.5 VL 4/16 D-7.5 VL 4/23 D-6.7 VL 4/23 D-6.7 VL 4/24 D-6.7 VL 4/24 D-6.7 VL 4/24 D-7.1 VL 4/24 D-7.1 VL 4/25 DL-6.7 VL 4/25 DL-6.7 VL 4/25 DL-7.1 VL 4/25 DL-7.1 VL 4/26 DL-7.5 VL 4/26 DL-7.5	XGA32021X/Y32021X 32019X XGA32021X/Y32021X 32019X XGA32021X/Y32021X 32019X 33214 33210 EK50011 32310 32314 32310 EK50011 32310 EK50011 32310 EK50011 32310 EK50011 32310 EK50011 32310 32314 32310			

APPLICATION LISTINGS - TRUCK



 		 			
MERCEDES-BENZ					
SK 1800 SERIES ...					
VL 4/27 D-7.5	32314				
VL 4/27 D-7.5	32310				
VL 4/27 D-7.5	32314				
VL 4/27 D-7.5	32310				
VL 4/28 D-7.5	32314				
VL 4/28 D-7.5	32310				
VL 4/29 D-7.5	32314				
VL 4/29 D-7.5	32310				
VL 4/30 DL-7.5	32314				
VL 4/30 DL-7.5	32310				
VL 4/31 DL-7.5	32314				
VL 4/31 DL-7.5	32310				
VL 4/31 DL-7.5	EK50011				
VL 4/31 DL-7.5	32310				
VL 4/36 D-6.7	EK50011				
VL 4/36 D-6.7	32310				
VL 4/38 D-7.1	EK50011				
VL 4/38 D-7.1	32310				
VL 5/1 D-9	32311				
VL 5/2 D-9	JH415647/10				
VL 5/2 D-9	32311				
VL 5/20 DC-9	32311				
VL 5/20 DC-9	32311				
VL 5/21 DC-9	32311				
VL 5/21 DC-9	32311				
HL 4/038 D-12		33020			
HL 4/038 D-12		33117			
HL 4/039 D-12		33020			
HL 4/039 D-12		33117			
HL 4/06 D-12		33020			
HL 4/06 D-12		33117			
HL 4/06 DL-12		33020			
HL 4/06 DL-12		33117			
HL 7/013 D-16		33022			
HL 7/015 D-13		33022			
HL 7/015 D-13		30220			
HL 7/015 D-13		33022			
HL 7/015 D-13		30220			
HL 7/015 DL-13		33022			
HL 7/015 DL-13		30220			
HL 7/015 DL-13		33022			
HL 7/015 DL-13		30220			
HL 7/024 D-12.3		33021			
HL 7/024 D-12.3		33019			
HL 7/024 DL-12.3		33021			
HL 7/024 DL-12.3		33019			
HL 7/025 D-12.3		33021			
HL 7/025 D-12.3		33019			
HL 7/07 D-10		33021			
HL 7/07 D-10		32019X			
HL 7/07 D-10		EK50021			
HL 7/07 D-10		32019X			
HL 7/07 D-11.5		33021			
HL 7/07 D-11.5		32019X			

APPLICATION LISTINGS - TRUCK







					
MERCEDES-BENZ					
SK 1800 SERIES ...					
	HL 7/07 D-11.5 HL 7/07 D-11.5 HL 7/07 D-11.5/4.572 HL 7/07 D-11.5/4.572 HL 7/07 D-11.5/4.572 HL 7/07 D-11.5/4.572 HL 7/07 DL-10 HL 7/07 DL-10 HL 7/07 DL-10 HL 7/07 DL-10 HL 7/07 DL-11.5 HL 7/07 DL-11.5 HL 7/07 DL-11.5 HL 7/07 DL-11.5 HL 7/26 D-12.3 HL 7/26 D-12.3 HL 7/26 DL-12.3 HL 7/26 DL-12.3 HL 7/50 DCS-11.5 HL 7/50 DCS-11.5 HL 7/50 DCS-11.5 HL 7/56 DS-16 HL 7/56 DS-16 HL 7/56 DS-16 NR 4/11 DL-7.5 NR 4/11 DL-7.5 NR 4/22-8 NR 4/22-8 NS 4/11 D-10 NS 4/11 D-10		EK50021 32019X 33021 32019X EK50021 32019X 33021 32019X EK50021 32019X 33021 33019 33021 33019 33021 32020X 33022 33021 32020X 33022 EK50011 32310 33019 33215 33019 33215		ABS,  021299- ABS,  021299- ABS,  021298 ABS,  021298 ABS,  021299- ABS,  021299- ABS,  021298 ABS,  021298 ABS,  021299- ABS,  021299- ABS,  021298 ABS,  021299- ABS,  021299- ABS,  021299- ABS,  021298 ABS,  021298 ABS,  021299- ABS,  021299- ABS,  021299- ABS,  021299- ABS,  021299- ABS,  021299- ABS,  021299- ABS,  021299- ABS,  021299- ABS,  021299- ABS,  021299- ABS,  021299- ABS,  021299-  3553564401  3553564401  3553563001  3553564401  3553564401  3553564401  3553563001
SK 1900 SERIES					
	AL 7/1 D-7 AL 7/1 D-7 VD 4/14 DL-7 VD 4/14 DL-7 VD 4/20 DL-7.5 VD 4/20 DL-7.5 VD 4/20 DL-7.5 VD 4/20 DL-7.5 VL 3/8 D-6.5 VL 3/8 D-6.5 VL 3/8-6 VL 3/8-6 VL 3/8-6 VL 3/8-6 VL 4/10 D-7 VL 4/10 D-7 VL 4/10 D-7 VL 4/10 D-7 VL 4/15 D-7.5 VL 4/15 D-7.5 VL 4/16 D-7.5 VL 4/16 D-7.5 VL 4/19 D-7.5	XGA32021X/Y32021X 32019X EK50011 32310 32314 32310 EK50011 33214 33210 33214 33209 33214 33210 EK50011 32310 EK50011 33210 32314 32310 32314 32310 32314 32310 32314		 1358881 -  1358881 -  - 1358880  - 1358880  1358881 -  1358881 -  1278814 -  1278814 -  - 1278813  - 1278813	































APPLICATION LISTINGS - TRUCK

A





















 		 			
MERCEDES-BENZ					
SK 1900 SERIES ...					
	VL 4/19 D-7.5	32310			
	VL 4/23 D-6.7	EK50011			
	VL 4/23 D-6.7	32310			
	VL 4/24 D-6.7	EK50011			
	VL 4/24 D-6.7	32310			
	VL 4/25 DL-6.7	EK50011			
	VL 4/25 DL-6.7	32310			
	VL 4/27 D-7.5	32314			
	VL 4/27 D-7.5	32310			
	VL 4/28 D-7.5	32314			
	VL 4/28 D-7.5	32310			
	VL 4/29 D-7.5	32314			
	VL 4/29 D-7.5	32310			
	VL 4/2-D7	30314			
	VL 4/2-D7	32310			
	VL 4/31 D-7.5	32314			
	VL 4/31 D-7.5	32310			
	VL 4/7 D-7	EK50011			
	VL 4/7 D-7	32310			
	VL 4/7 D-7	EK50011			
	VL 4/7 D-7	33210			
	VL 4/9 D-7	EK50011			
	VL 4/9 D-7	32310			
	VL 4/9 D-7	EK50011			
	VL 4/9 D-7	33210			
	VL 5/1 D-9	JH415647/10			
	VL 5/1 D-9	32311			
	VL 5/2 D-9	JH415647/10			
	VL 5/2 D-9	32311			
	HD 7/016 DG-13		33022		
	HD 7/016 DG-13		30220		
	HD 7/016 DG-13		33022		
	HD 7/016 DG-13		30220		
	HL 7/013 D-16		33022		
	HL 7/015 D-13		33022		
	HL 7/015 D-13		30220		
	HL 7/015 D-13		33022		
	HL 7/015 D-13		30220		
	HL 7/015 DL-13		33022		
	HL 7/015 DL-13		30220		
	HL 7/015 DL-13		33022		
	HL 7/015 DL-13		30220		
	HL 7/015 DS-13		33022		
	HL 7/015 DS-13		30220		
	HL 7/015 DS-13		33022		
	HL 7/015 DS-13		30220		
	HL 7/07 D-10		33021		
	HL 7/07 D-10		32019X		
	HL 7/07 D-10		EK50021		
	HL 7/07 D-10		32019X		
	HL 7/07 DL-10		33021		
	HL 7/07 DL-10		32019X		
	HL 7/07 DL-10		EK50021		
	HL 7/07 DL-10		32019X		

-  1278814 -
-  1278814 -
-  - 1278813
-  - 1278813
-  1278814 -
-  1278814 -
-  - 1278813
-  - 1278813

-  - 021298
-  - 021298
-  - 021299-
-  - 021299-
-  - 021298
-  - 021298
-  - 021299-
-  - 021299-
-  - 021298
-  - 021298
-  - 021299-
-  - 021299-
-  - 021298
-  - 021298
-  - 021299-
-  - 021299-
-  - 021298
-  - 021298
-  - 021299-
-  - 021299-























































APPLICATION LISTINGS - TRUCK

								
MERCEDES-BENZ								
SK 1900 SERIES ...								
	HL 7/1-10		33021		 - 021298			
	HL 7/1-10		32019X		 - 021298			
	HL 7/1-10		EK50021		 021299-			
	HL 7/1-10		32019X		 021299-			
	HL 7/15 D-13		33022		 - 021298			
	HL 7/15 D-13		30220		 - 021298			
	HL 7/15 D-13		33022		 021299-			
	HL 7/15 D-13		30220		 021299-			
	HL 7/18 D-13		33022		 - 021298			
	HL 7/18 D-13		30220		 - 021298			
	HL 7/18 D-13		33022		 021299-			
	HL 7/18 D-13		30220		 021299-			
	NS 4/11 D-10		33019					
	NS 4/11 D-10		33215					
SK 2000 SERIES								
	AL 7/1 D-7	XGA32021X/Y32021X						
	AL 7/1 D-7	32019X						
	AL 7/1 D-7.637	XGA32021X/Y32021X						
	AL 7/1 D-7.637	32019X						
	AL 7/1 D-7/5.217	XGA32021X/Y32021X						
	AL 7/1 D-7/5.217	32019X						
	AL 7/10 D-7.769	XGA32021X/Y32021X						
	AL 7/10 D-7.769	32019X						
	VD 4/14 DL-7	EK50011						
	VD 4/14 DL-7	32310						
	VD 4/20 DL-7.5	32314						
	VD 4/20 DL-7.5	32310						
	VL 3/13 D-5.3	33214						
	VL 3/13 D-5.3	33209						
	VL 4/10 D-7	EK50011						
	VL 4/10 D-7	32310						
	VL 4/10 D-7	EK50011						
	VL 4/10 D-7	33210						
	VL 4/14 D-7	EK50011						
	VL 4/14 D-7	32310						
	VL 4/16 D-7.5	32314						
	VL 4/16 D-7.5	32310						
	VL 4/23 D-6.7	EK50011						
	VL 4/23 D-6.7	32310						
	VL 4/24 D-6.7	EK50011						
	VL 4/24 D-6.7	32310						
	VL 4/24 D-7.1	EK50011						
	VL 4/24 D-7.1	32310						
	VL 4/27 D-7.5	32314						
	VL 4/27 D-7.5	32310						
	VL 4/28 D-7.5	32314						
	VL 4/28 D-7.5	32310						
	VL 4/9 D-7	EK50011						
	VL 4/9 D-7	32310						
	VL 5/1 D-9	JH415647/10						
	VL 5/1 D-9	32311						
	VL 5/2 D-9	JH415647/10						
	VL 5/2 D-9	32311						









APPLICATION LISTINGS - TRUCK















































 		 			
MERCEDES-BENZ					
SK 2000 SERIES ...					
	VL 5/20 DC-9	32311			
	VL 5/20 DC-9	32311			
	HD 7/014 DGS-16		33022		 - 021298
	HD 7/19 DG-13		33022		 - 021298
	HD 7/19 DG-13		30220		 - 021299-
	HD 7/19 DG-13		33022		 - 021299-
	HD 7/19 DG-13		30220		 - 021299-
	HD 7/2 DG-10		33021		 - 021298
	HD 7/2 DG-10		32019X		 - 021298
	HD 7/2 DG-10		EK50021		 - 021299-
	HD 7/2 DG-10		32019X		 - 021299-
	HL 4/01 D-10		33020		
	HL 4/01 D-10		33117		
	HL 4/32 D-10.6		33019		
	HL 4/32 D-10.6		33215		
	HL 7/013 D-16		33022		
	HL 7/015 D-13		33022		 - 021298
	HL 7/015 D-13		30220		 - 021298
	HL 7/015 D-13		33022		 - 021299-
	HL 7/015 D-13		30220		 - 021299-
	HL 7/015 DL-13		33022		 - 021298
	HL 7/015 DL-13		30220		 - 021298
	HL 7/015 DL-13		33022		 - 021299-
	HL 7/015 DL-13		30220		 - 021299-
	HL 7/015 DS-13		33022		 - 021298
	HL 7/015 DS-13		30220		 - 021298
	HL 7/015 DS-13		33022		 - 021299-
	HL 7/015 DS-13		30220		 - 021299-
	HL 7/015 DS-13		30220		 - 021299-
	HL 7/02 D-10		33021		 - 021298
	HL 7/02 D-10		32019X		 - 021298
	HL 7/02 D-10		EK50021		 - 021299-
	HL 7/02 D-10		32019X		 - 021299-
	HL 7/021 D-10		EK50021		 - 021299-
	HL 7/021 D-10		32019X		 - 021299-
	HL 7/07 D-10		33021		 - 021298
	HL 7/07 D-10		32019X		 - 021298
	HL 7/07 D-10		EK50021		 - 021299-
	HL 7/07 D-10		32019X		 - 021299-
	HL 7/07 DL-10		33021		 - 021298
	HL 7/07 DL-10		32019X		 - 021298
	HL 7/07 DL-10		EK50021		 - 021299-
	HL 7/07 DL-10		32019X		 - 021299-
	HL 7/07 DS-10		33021		 - 021298
	HL 7/07 DS-10		32019X		 - 021298
	HL 7/07 DS-10		EK50021		 - 021299-
	HL 7/07 DS-10		32019X		 - 021299-
	HL 7/1 D L-10		33021		 - 021298
	HL 7/1 D L-10		32019X		 - 021298
	HL 7/1 D L-10		EK50021		 - 021299-
	HL 7/1 D L-10		32019X		 - 021299-
	HL 7/18 D-13		33022		 - 021298
	HL 7/18 D-13		30220		 - 021298
	HL 7/18 D-13		33022		 - 021299-
	HL 7/18 D-13		30220		 - 021299-

APPLICATION LISTINGS - TRUCK



     					
MERCEDES-BENZ SK 2200 SERIES					
VD 4/14 DL-7	EK50011				
VD 4/14 DL-7	32310				
VD 4/20 DL-7.5	EK50011				● 1278814 -
VD 4/20 DL-7.5	33210				● 1278814 -
VD 4/20 DL-75	32314				
VD 4/20 DL-75	32310				
VD 4/20 DL-75	32310				
VL 3/8 D-6.5	33214				
VL 3/8 D-6.5	33210				
VL 3/8-6	33214				● - 1358880
VL 3/8-6	33209				● - 1358880
VL 3/8-6	33214				● 1358881 -
VL 3/8-6	33210				● 1358881 -
VL 4/10 D-7	EK50011				● 1278814 -
VL 4/10 D-7	32310				● 1278814 -
VL 4/10 D-7	EK50011				
VL 4/10 D-7	33210				
VL 4/10 D-7	EK50011				● - 1278813
VL 4/10 DL-7	EK50011				
VL 4/10 DL-7	33210				
VL 4/15 D-7.5	32314				
VL 4/15 D-7.5	32310				
VL 4/16 D-7.5	32314				
VL 4/16 D-7.5	32310				
VL 4/28 D-7.5	32314				
VL 4/28 D-7.5	32310				
VL 4/30 D-7.5	32314				
VL 4/30 D-7.5	32310				
VL 4/30 DL-7.5	32314				
VL 4/30 DL-7.5	32310				
VL 4/8 D-7	EK50011				● - 1278813
VL 4/8 D-7	33210				● - 1278813
VL 4/9 D-7	EK50011				● 1278814 -
VL 4/9 D-7	32310				● 1278814 -
VL 4/9 D-7	EK50011				● - 1278813
VL 4/9 D-7	33210				● - 1278813
VL 4/9 D-7	EK50011				
VL 4/9 D-7	32310				
HD 4/02 DG-10		33020			
HD 4/02 DG-10		33117			
HD 4/02 GD-10		33020			
HD 4/02 GD-10		33117			
HD 4/03 D-10		33020			
HD 4/03 D-10		33117			
HD 4/2 DG-10		33020			
HD 4/2 DG-10		33117			
HD 4/21 DG-10		33019			
HD 4/21 DG-10		33215			
HD 4/21 G-10		33019			
HD 4/21 G-10		33215			
HD 4/22 D-10		33019			
HD 4/22 D-10		33215			
HD 4/22 DG-10		33019			
HD 4/22 DG-10		33215			
HD 4/22-10		33019			

APPLICATION LISTINGS - TRUCK

A						
MERCEDES-BENZ SK 2200 SERIES ...						
	HD 4/22-10		33215		 - 021298	
	HD 7/09 DG-10		33021		 - 021298	
	HD 7/09 DG-10		32019X		 - 021299-	
	HD 7/09 DG-10		EK50021		 - 021299-	
	HD 7/09 DG-10		32019X		 - 021299-	
	HD 7/11 DG-9		32021X			
	HD 7/11 DG-9		32019X			
	HD 7/19 DG-13		33022		 - 021298	
	HD 7/19 DG-13		30220		 - 021298	
	HD 7/19 DG-13		33022		 - 021299-	
	HD 7/19 DG-13		30220		 - 021299-	
	HD 7/2 DG-10		33021		 - 021298	
	HD 7/2 DG-10		32019X		 - 021298	
	HD 7/2 DG-10		EK50021		 - 021299-	
	HD 7/2 DG-10		32019X		 - 021299-	
	HD 7/2 DLG-10		33021		 - 021298	
	HD 7/2 DLG-10		32019X		 - 021298	
	HD 7/2 DLG-10		EK50021		 - 021299-	
	HD 7/2 DLG-10		32019X		 - 021299-	
	HD 7/5 DG-10		33021		 - 021298	
	HD 7/5 DG-10		32019X		 - 021298	
	HD 7/5 DG-10		EK50021		 - 021299-	
	HD 7/5 DG-10		32019X		 - 021299-	
	HL 4/01 D-10		33020			
	HL 4/01 D-10		33117			
	HL 4/01 DL-10		33020			
	HL 4/01 DL-10		33117			
	HL 4/01-10		33020			
	HL 4/01-10		33117			
	HL 4/06 D-12		33020			
	HL 4/06 D-12		33117			
	HL 4/06 DL-12		33020			
	HL 4/06 DL-12		33117			
	HL 5/2 ZL-10		33019			
	HL 5/2 ZL-10		33215			
	HL 7/015 D-13		33022		 - 021298	
	HL 7/015 D-13		30220		 - 021298	
	HL 7/015 D-13		33022		 - 021299-	
	HL 7/015 D-13		30220		 - 021299-	
	HL 7/015 DS-13		33022		 - 021298	
	HL 7/015 DS-13		30220		 - 021298	
	HL 7/015 DS-13		33022		 - 021299-	
	HL 7/015 DS-13		30220		 - 021299-	
	HL 7/021 D-10		33021		 - 021298	
	HL 7/021 D-10		32019X		 - 021298	
	HL 7/021 D-10		EK50021		 - 021299-	
	HL 7/021 D-10		32019X		 - 021299-	
	HL 7/021 DL-10		33021		 - 021298	
	HL 7/021 DL-10		32019X		 - 021298	
	HL 7/021 DL-10		EK50021		 - 021299-	
	HL 7/021 DL-10		32019X		 - 021299-	
	HL 7/024 DL-12.3		33021			
	HL 7/024 DL-12.3		33019			
	HL 7/07 D-10		33021		 - 021298	

APPLICATION LISTINGS - TRUCK



MERCEDES-BENZ					
SK 2200 SERIES ...					
HL 7/07 D-10			32019X		ABS - 021298
HL 7/07 D-10			EK50021		ABS - 021299-
HL 7/07 D-10			32019X		ABS - 021299-
HL 7/07 DL-10			33021		ABS - 021298
HL 7/07 DL-10			32019X		ABS - 021298
HL 7/07 DL-10			EK50021		ABS - 021299-
HL 7/07 DL-10			32019X		ABS - 021299-
HL 7/07 DS-10			33021		ABS - 021298
HL 7/07 DS-10			32019X		ABS - 021298
HL 7/07 DS-10			EK50021		ABS - 021299-
HL 7/07 DS-10			32019X		ABS - 021299-
HL 7/1 D-10			33021		ABS - 021298
HL 7/1 D-10			32019X		ABS - 021298
HL 7/1 D-10			EK50021		ABS - 021299-
HL 7/1 D-10			32019X		ABS - 021299-
HL 7/1 DL-10			33021		ABS - 021298
HL 7/1 DL-10			32019X		ABS - 021299-
HL 7/1 DL-10			EK50021		ABS - 021299-
HL 7/1 DL-10			32019X		ABS - 021299-
HL 7/1 DL-10			33213		ABS - 021299-
HL 7/1 DL-10			33208		ABS - 021299-
HL 7/1 L-10			33021		ABS - 021298
HL 7/1 L-10			32019X		ABS - 021298
HL 7/1 L-10			EK50021		ABS - 021299-
HL 7/1 L-10			32019X		ABS - 021299-
HL 7/10-D9			33021		ABS - 021298
HL 7/10-D9			32019X		ABS - 021298
HL 7/10-D9			EK50021		ABS - 021299-
HL 7/10-D9			32019X		ABS - 021299-
HL 7/1-10			EK50021		ABS - 021299-
HL 7/18 D-13			33022		ABS - 021298
HL 7/18 D-13			30220		ABS - 021298
HL 7/18 D-13			33022		ABS - 021299-
HL 7/18 D-13			30220		ABS - 021299-
HL 7/2 DG-10			33021		ABS - 021298
HL 7/2 DG-10			32019X		ABS - 021298
HL 7/2 DG-10			EK50021		ABS - 021299-
HL 7/2 DG-10			32019X		ABS - 021299-
HL 7/3 D-10			33021		ABS - 021298
HL 7/3 D-10			32019X		ABS - 021298
HL 7/3 D-10			EK50021		ABS - 021299-
HL 7/3 D-10			32019X		ABS - 021299-
HL 7/3 D-10			33213		ABS - 021299-
HL 7/3 D-10			33208		ABS - 021299-
HL 7/3 DL-10			33021		ABS - 021298
HL 7/3 DL-10			32019X		ABS - 021298
HL 7/3 DL-10			EK50021		ABS - 021299-
HL 7/3 DL-10			32019X		ABS - 021299-
HL 7/3 DS-10			33021		ABS - 021298
HL 7/3 DS-10			32019X		ABS - 021298
HL 7/3 DS-10			EK50021		ABS - 021299-
HL 7/3 DS-10			32019X		ABS - 021299-
HL 7/4 D-10			33021		ABS - 021298
HL 7/4 D-10			32019X		ABS - 021298



APPLICATION LISTINGS - TRUCK









































MERCEDES-BENZ									
SK 2200 SERIES ...									
	HL 7/4 D-10		EK50021			ABS	021299-		
	HL 7/4 D-10		32019X			ABS	021299-		
	NR 4/10 DL-6		30314						
	NR 4/10 DL-6		32310						
	NR 4/10 DL-6		EK50011						
	NR 4/10 DL-6		32310						
	NR 4/11 DL-7.5		EK50011						
	NR 4/11 DL-7.5		32310						
	NS 4/10 D-6		30314						
	NS 4/10 D-6		32310						
	NS 4/10 D-6.7		EK50011						
	NS 4/10 D-6.7		33210						
	NS 4/11 D-10		33019						
	NS 4/11 D-10		33215						
SK 2300 SERIES									
	VD 4/26 DL-7.5	32314							
	VD 4/26 DL-7.5	32310							
	HD 7/5 DG-10	33021							
	HD 7/5 DG-10	32019X							
	HD 7/5 DG-10	EK50021							
	HD 7/5 DG-10	32019X							
SK 2400 SERIES									
	VD 4/20 DL-7.5	32314							
	VD 4/20 DL-7.5	32310							
	VD 4/26DL-7.5	32314							
	VD 4/26DL-7.5	32310							
	VL 4/10 D-7	32310							
	VL 4/10 D-7	EK50011							
	VL 4/10 DL-7	EK50011							
	VL 4/14 DL-7	EK50011							
	VL 4/14 DL-7	32310							
	VL 4/15 D-7.5	32310							
	VL 4/16 D-7.5	32310							
	VL 4/23 D-6.7	EK50011							
	VL 4/23 D-6.7	32310							
	VL 4/24 D-6.7	EK50011							
	VL 4/24 D-6.7	32310							
	VL 4/24 D-7.1	EK50011							
	VL 4/24 D-7.1	32310							
	VL 4/25 DL-6.7	EK50011							
	VL 4/25 DL-6.7	32310							
	VL 4/27 D-7.5	32314							
	VL 4/27 D-7.5	32310							
	VL 4/28 D-7.5	EK50011							
	VL 4/28 D-7.5	32310							
	VL 4/28 D-7.5	32314							
	VL 4/28 D-7.5	32310							
	VL 4/29 D-7.5	32314							
	VL 4/29 D-7.5	32310							
	VL 4/30 D-7.5	32314							
	VL 4/30 D-7.5	32310							
	VL 4/30 DL-7.5	32314							















































APPLICATION LISTINGS - TRUCK



 		 			
MERCEDES-BENZ					
SK 2400 SERIES ...					
VL 4/30 DL-7.5	32310				
VL 4/31 DL-7.5	32314				
VL 4/31 DL-7.5	32310				
VL 4/7 D-7	EK50011				
VL 4/7 D-7	32310				
VL 4/7 D-7	EK50011				
VL 4/7 D-7	32310				
VL 4/7 DL-7	EK50011				
VL 4/7 DL-7	32310				
VL 4/9 D-7	EK50011				
VL 4/9 D-7	32310				
VL 5/2 D-9	JH415647/10				
VL 5/2 D-9	32311				
HD 4/21 DG-10		33019			
HD 4/21 DG-10		33215			
HD 4/22 D-10		33019			
HD 4/22 D-10		33215			
HD 7/016 DG-13		33022			
HD 7/016 DG-13		30220			
HD 7/016 DG-13		33022			
HD 7/016 DG-13		30220			
HD 7/016 DG-13		33022			
HD 7/016 DG-13		33022			
HD 7/016 DG-13		30220M			
HD 7/016 DG-13		30220M			
HD 7/09 DG-10		33021			
HD 7/09 DG-10		32019X			
HD 7/09 DG-10		EK50021			
HD 7/09 DG-10		32019X			
HD 7/19 DG-13		33022			
HD 7/19 DG-13		30220			
HD 7/19 DG-13		33022			
HD 7/2 DG-10		33021			
HD 7/2 DG-10		32019X			
HD 7/2 DG-10		EK50021			
HD 7/2 DG-10		32019X			
HD 7/5 DG-10		33021			
HD 7/5 DG-10		32019X			
HD 7/5 DG-10		EK50021			
HD 7/5 DG-10		32019X			
HL 4/038 D-12		33020			
HL 4/038 D-12		33117			
HL 4/039 D L-12		33020			
HL 4/039 D L-12		33117			
HL 4/039 D-12		33020			
HL 4/039 D-12		33117			
HL 4/06 D-12		33020			
HL 4/06 D-12		33117			
HL 4/06 DL-12		33020			
HL 4/06 DL-12		33117			
HL 7/015 D-13		33022			
HL 7/015 D-13		30220			
HL 7/015 D-13		33022			
HL 7/015 D-13		30220			
				 1278814 -  1278814 -  1278813 -  1278813 -  1278814 -  1278813 -  1278814 -  1278814 - 	
				 021298  021298  021299-  021299-  021298  021299-  021298  021299-  021298  021299-  021298  021299-  021298  021299-  021298  021299-  021298  021299-  021298  021299-  021298 	
				 021298  021298  021299-  021299- 	































































APPLICATION LISTINGS - TRUCK



					
MERCEDES-BENZ SK 2400 SERIES ...					
HL 7/016 DG-13			30220	 - 021299-	
HL 7/021 D-10			33021	 - 021298	
HL 7/021 D-10			32019X	 - 021298	
HL 7/021 D-10			EK50021	 - 021299-	
HL 7/021 D-10			32019X	 - 021299-	
HL 7/024 D-12.3			33021		
HL 7/024 D-12.3			33019		
HL 7/024 DL-12.3			33021		
HL 7/024 DL-12.3			33019		
HL 7/025 D-12.3			33021		
HL 7/025 D-12.3			33019		
HL 7/026 D-12.3			33021		
HL 7/026 D-12.3			33019		
HL 7/026 DL-12.3			33021		
HL 7/026 DL-12.3			33019		
HL 7/07 D-10			33021	 - 021298	
HL 7/07 D-10			32019X	 - 021298	
HL 7/07 D-10			EK50021	 - 021299-	
HL 7/07 D-10			32019X	 - 021299-	
HL 7/07 D-11.5			33021	 - 021298	
HL 7/07 D-11.5			32019X	 - 021298	
HL 7/07 D-11.5			EK50021	 - 021299-	
HL 7/07 D-11.5			32019X	 - 021299-	
HL 7/07 DL -11.5			33021	 - 021298	
HL 7/07 DL -11.5			32019X	 - 021298	
HL 7/07 DL-10			33021	 - 021298	
HL 7/07 DL-10			32019X	 - 021298	
HL 7/07 DL-10			EK50021	 - 021299-	
HL 7/07 DL-10			32019X	 - 021299-	
HL 7/07 DL-11.5			EK50021	 - 021299-	
HL 7/07 DL-11.5			32019X	 - 021299-	
HL 7/126 DL-12.3			EK50021	 - 021299-	
HL 7/126 DL-12.3			32019X	 - 021299-	
HL 7/15DL-13			33022	 - 021298	
HL 7/15DL-13			30220	 - 021298	
HL 7/15DL-13			33022	 - 021299-	
HL 7/15DL-13			30220	 - 021299-	
HL 7/26 D-12.3			33019-90KA1		
HL 7/26 DL-12.3			33021	 - 021298	
HL 7/26 DL-12.3			32019X	 - 021298	
HL 7/26 DL-12.3			EK50021	 - 021299-	
HL 7/26 DL-12.3			33019-90KA1		
HL 7/3 D-10			33021	 - 021298	
HL 7/3 D-10			32019X	 - 021298	
HL 7/3 D-10			EK50021	 - 021299-	
HL 7/3 D-10			32019X	 - 021299-	
HL 7/4 D-10			33021	 - 021298	
HL 7/4 D-10			32019X	 - 021298	
HL 7/4 D-10			EK50021	 - 021299-	
HL 7/4 D-10			32019X	 - 021299-	
NL 4/11 DL-7.5			EK50011		
NL 4/11 DL-7.5			32310		
NS 4/10 D-6.7			EK50011		
NS 4/10 D-6.7			33210		







APPLICATION LISTINGS - TRUCK







































							
MERCEDES-BENZ							
SK 2400 SERIES ...							
	NS 4/11 D-10			33019			
	NS 4/11 D-10			33215			
SK 2500 SERIES							
	VD 4/26DL-7.5	32314					
	VD 4/26DL-7.5	32310					
	VL 4/10 D-7	EK50011					
	VL 4/10 D-7	32310					
	VL 4/16 D-7.5	32314					
	VL 4/16 D-7.5	32310					
	VL 4/23 D-6.7	EK50011					
	VL 4/23 D-6.7	32310					
	VL 4/24 D-6.7	EK50011					
	VL 4/24 D-6.7	32310					
	VL 4/25 DL-6.7	EK50011					
	VL 4/25 DL-6.7	32310					
	VL 4/27 D-7.5	32314					
	VL 4/27 D-7.5	32310					
	VL 4/28 D-7.5	32314					
	VL 4/28 D-7.5	32310					
	VL 4/28 D-7.5	EK50011					
	VL 4/28 D-7.5	32310					
	VL 4/29 D-7.5	32314					
	VL 4/29 D-7.5	32310					
	VL 4/30 D-7.5	32314					
	VL 4/30 D-7.5	32310					
	VL 4/30 DL-7.5	32314					
	VL 4/30 DL-7.5	32310					
	VL 4/31 D L-7	EK50011					
	VL 4/31 D L-7	32310					
	VL 4/31 DL-7.5	32314					
	VL 4/31 DL-7.5	32310					
	VL 4/36 D-6.7	EK50011					
	VL 4/36 D-6.7	32310					
	VL 5/1 D-9	JH415647/10					
	VL 5/1 D-9	32311					
	VL 5/2 D-9	JH415647/10					
	VL 5/2 D-9	32311					
	VL 5/21 DC-9	32311					
	VL 5/21 DC-9	32311					
	HD 4/02 DG-10			33020			
	HD 4/02 DG-10			33117			
	HD 4/03 D-10			33020			
	HD 4/03 D-10			33117			
	HD 4/21 DG-10			33019			
	HD 4/21 DG-10			33215			
	HD 4/22 D-10			33019			
	HD 4/22 D-10			33215			
	HD 7/09 DG-10			33021			 - 021298
	HD 7/09 DG-10			32019X			 - 021298
	HD 7/09 DG-10			EK50021			 021299-
	HD 7/09 DG-10			32019X			 021299-
	HD 7/19 DG-13			33022			 - 021298
	HD 7/19 DG-13			30220			 - 021298

APPLICATION LISTINGS - TRUCK



					
MERCEDES-BENZ SK 2500 SERIES ...					
	HD 7/19 DG-13 HD 7/19 DG-13 HD 7/2 DG-10 HD 7/2 DG-10 HD 7/2 DG-10 HD 7/2 DG-10 HD 7/4 D-10/3.978 HD 7/4 D-10/3.978 HD 7/4 D-10/3.978 HD 7/4 D-10/3.978 HD 7/5 DG-10 HD 7/5 DG-10 HD 7/5 DG-10 HD 7/5 DG-10 HD 7/5 DG-10/3.978 HD 7/5 DG-10/3.978 HD 7/5 DG-10/3.978 HD 7/5 DG-10/3.978 HD 7/5 DG-10/3.978 HL 4/038 D-12 HL 4/038 D-12 HL 4/039 D L-12 HL 4/039 D L-12 HL 4/039 D-12 HL 4/039 D-12 HL 4/06 D-12 HL 4/06 D-12 HL 4/06 DL-12 HL 4/06 DL-12 HL 7/015 D L-13 HL 7/015 D L-13 HL 7/015 D L-13 HL 7/015 D L-13 HL 7/015 D-13 HL 7/015 D-13 HL 7/015 D-13 HL 7/015 D-13 HL 7/016 DG-13 HL 7/016 DG-13 HL 7/016 DG-13 HL 7/016 DG-13 HL 7/024 D-12.3 HL 7/024 D-12.3 HL 7/024 DL-12.3 HL 7/024 DL-12.3 HL 7/025 D-12.3 HL 7/025 D-12.3 HL 7/07 D-10 HL 7/07 D-10 HL 7/07 D-10 HL 7/07 D-10 HL 7/07 D-11.5 HL 7/07 D-11.5 HL 7/07 D-11.5 HL 7/07 D-11.5		33022 30220 33021 32019X EK50021 32019X 33021 32019X EK50021 32019X 33021 32019X EK50021 32019X 33021 32019X EK50021 32019X 33020 33117 33020 33117 33020 33117 33020 33117 33020 33117 33022 30220 33022 30220 33022 30220 33022 30220 33022 30220 33021 33019 33021 33019 33021 33019 33021 32019X EK50021 32019X 33021 32019X EK50021 32019X		ABS, ● - 021299- ABS, ● - 021299- ABS, ● - 021298 ABS, ● - 021298 ABS, ● - 021299- ABS, ● - 021299- ABS, ● - 021298 ABS, ● - 021298 ABS, ● - 021299- ABS, ● - 021299- ABS, ● - 021298 ABS, ● - 021298 ABS, ● - 021299- ABS, ● - 021299- ABS, ● - 021298 ABS, ● - 021298 ABS, ● - 021299- ABS, ● - 021299- ABS, ● - 021298 ABS, ● - 021298 ABS, ● - 021299- ABS, ● - 021299- ABS, ● - 021298 ABS, ● - 021298 ABS, ● - 021299- ABS, ● - 021299- ABS, ● - 021298 ABS, ● - 021298 ABS, ● - 021299- ABS, ● - 021299- ABS, ● - 021298 ABS, ● - 021298 ABS, ● - 021299- ABS, ● - 021299- ABS, ● - 021298 ABS, ● - 021298







APPLICATION LISTINGS - TRUCK

		 		
MERCEDES-BENZ				
SK 2500 SERIES ...				
	HL 7/07 DL-10		33021	 - 021298
	HL 7/07 DL-10		32019X	 - 021298
	HL 7/07 DL-10		EK50021	 - 021299-
	HL 7/07 DL-10		32019X	 - 021299-
	HL 7/07 DL-11.5		33022	 - 021298
	HL 7/07 DL-11.5		30220	 - 021298
	HL 7/07 DL-11.5		33022	 - 021299-
	HL 7/07 DL-11.5		30220	 - 021299-
	HL 7/07 DL-11.5		33021	 - 021298
	HL 7/07 DL-11.5		32019X	 - 021298
	HL 7/07 DL-11.5		EK50021	 - 021299-
	HL 7/07 DL-11.5		32019X	 - 021299-
	HL 7/15D-13		33022	 - 021298
	HL 7/15D-13		30220	 - 021298
	HL 7/15D-13		33022	 - 021299-
	HL 7/15D-13		30220	 - 021299-
	HL 7/18 D-13		33022	 - 021298
	HL 7/18 D-13		30220	 - 021298
	HL 7/18 D-13		33022	 - 021299-
	HL 7/18 D-13		30220	 - 021299-
	HL 7/3 D-10		33021	 - 021298
	HL 7/3 D-10		32019X	 - 021298
	HL 7/3 D-10		EK50021	 - 021299-
	HL 7/3 D-10		32019X	 - 021299-
	HL 7/4 D-10		33021	 - 021298
	HL 7/4 D-10		32019X	 - 021298
	HL 7/4 D-10		EK50021	 - 021299-
	HL 7/4 D-10		32019X	 - 021299-
	NR 4/11 DL-7.5		EK50011	
	NR 4/11 DL-7.5		32310	
	NS 4/10 D-6.7		EK50011	
	NS 4/10 D-6.7		33210	
	NS 4/11 D-10		33019	
	NS 4/11 D-10		33215	
SK 2600 SERIES				
	VD 4/14 DL-7	EK50011		
	VD 4/14 DL-7	32310		
	VD 4/20 DL-7.5	32314		
	VD 4/20 DL-7.5	32310		
	VD 4/26 DL-7.5	32314		
	VD 4/26 DL-7.5	32310		
	VL 4/10 D-7	EK50011		
	VL 4/10 D-7	32310		
	VL 4/10 D-7	EK50011		 - 1278813
	VL 4/10 D-7	EK50011		 - 1278814 -
	VL 4/10 D-7	32310		 - 1278814 -
	VL 4/15 D-7.5	32310		
	VL 4/16 D-7.5	32310		
	VL 4/19 D-7.5	32310		
	VL 4/23 D-6.7	EK50011		
	VL 4/23 D-6.7	32310		
	VL 4/24 D-6.7	EK50011		
	VL 4/24 D-6.7	32310		











APPLICATION LISTINGS - TRUCK



 		 			
MERCEDES-BENZ					
SK 2600 SERIES ...					
VL 4/25 DL-6.7	EK50011				
VL 4/25 DL-6.7	32310				
VL 4/27 D-7.5	32314				
VL 4/27 D-7.5	32310				
VL 4/28 D-7.5	32314				
VL 4/28 D-7.5	32310				
VL 4/29 D-7.5	32314				
VL 4/29 D-7.5	32310				
VL 4/31 DL-7.5	32314				
VL 4/31 DL-7.5	32310				
VL 4/7 D-7	EK50011				
VL 4/7 D-7	32310				
VL 4/7 D-7	EK50011				
VL 4/7 D-7	33210				
VL 4/8 D-7	EK50011				
VL 4/8 D-7	33210				
VL 4/9 D-7	EK50011				
VL 4/9 D-7	33210				
VL 4/9 D-7	EK50011				
VL 4/9 D-7	33210				
VL 4/9-D7	EK50011				
VL 4/9-D7	32310				
VL 5/1 D-9	JH415647/10				
VL 5/1 D-9	32311				
VL 5/2 D-9	JH415647/10				
VL 5/2 D-9	32311				
HD 4/02 DG-10		33020			
HD 4/02 DG-10		33117			
HD 4/03 D-10		33020			
HD 4/03 D-10		33117			
HD 7/014 DGS-16		33022			
HD 7/016 DG-13		33022			
HD 7/016 DG-13		30220			
HD 7/016 DG-13		33022			
HD 7/016 DG-13		30220			
HD 7/19 DG-13		33022			
HD 7/19 DG-13		30220			
HD 7/19 DG-13		33022			
HD 7/19 DG-13		30220			
HD 7/19 DG-13		33022			
HD 7/19 DG-13		30220			
HD 7/2 DG-10		33021			
HD 7/2 DG-10		32019X			
HD 7/2 DG-10		EK50021			
HD 7/2 DG-10		32019X			
HL 4/01 DL-10		33020			
HL 4/01 DL-10		33117			
HL 7/013 D-16		33022			
HL 7/015 D-13		33022			
HL 7/015 D-13		30220			
HL 7/015 D-13		33022			
HL 7/015 D-13		30220			
HL 7/015 DL-13		33022			
HL 7/015 DL-13		30220			
HL 7/015 DL-13		33022			
HL 7/015 DL-13		30220			
HL 7/015 DL-13		33022			
HL 7/015 DL-13		30220			
HL 7/07 D-10		33021			
HL 7/07 D-10		32019X			



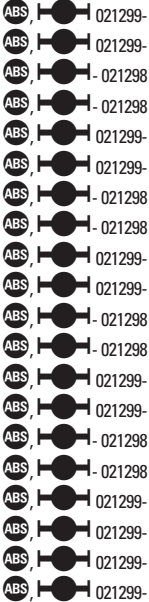

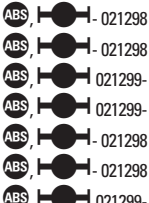

































APPLICATION LISTINGS - TRUCK



					
MERCEDES-BENZ					
SK 2600 SERIES ...					
	HL 7/07 D-10 HL 7/07 D-10 HL 7/1-10 HL 7/1-10 HL 7/1-10 HL 7/1-10 HL 7/18 D-13 HL 7/18 D-13 HL 7/18 D-13 HL 7/18 D-13 HL 7/18 DS-13 HL 7/18 DS-13 HL 7/18 DS-13 HL 7/18 DS-13 HL 7/3 D-10 HL 7/3 D-10 HL 7/3 D-10 HL 7/3 D-10 HL 7/3 D-10 HL 7/3 D-10		EK50021 32019X 33021 32019X EK50021 32019X 33022 30220 33022 30220 33022 30220 33022 30220 33022 30220 33021 32019X EK50021 32019X 33213 33208		
SK 2800 SERIES					
	VD 4/20 DL-7.5 VD 4/20 DL-7.5 VL 4/10 D-7 VL 4/10 D-7 VL 4/16 D-7.5 VL 4/16 D-7.5	EK50011 33210 EK50011 32310 32314 32310			
SK 3000 SERIES					
	VD 4/20 DL-7.5 VD 4/20 DL-7.5 VD 4/20 DL-7.5 VD 4/20 DL-7.5 VL 4/10 D-7 VL 4/10 D-7 VL 4/15 D-7.5 VL 4/15 D-7.5 VL 4/16 D-7.5 VL 4/16 D-7.5 VL 4/27 D-7.5 VL 4/27 D-7.5 VL 4/9 D-7 VL 4/9 D-7 VL 5/2 D-9 VL 5/2 D-9 HD 7/014 DGS-16 HD 7/016 DG-13 HD 7/016 DG-13 HD 7/016 DG-13 HD 7/016 DG-13 HD 7/2 DG-10 HD 7/2 DG-10 HD 7/2 DG-10	EK50011 33210 32314 32310 EK50011 32310 32314 32310 32314 32310 32314 32310 32314 32310 EK50011 32310 JH415647/10 33211 33022 33022 30220 33022 30220 33021 32019X EK50021			

APPLICATION LISTINGS - TRUCK



		 		
MERCEDES-BENZ				
SK 3200 SERIES ...				
	HD 7/19 DG-13		33022	 - 021298
	HD 7/19 DG-13		30220	 - 021298
	HD 7/19 DG-13		33022	 - 021299-
	HD 7/19 DG-13		30220	 - 021299-
	HD 7/2 DG-10		33021	 - 021298
	HD 7/2 DG-10		32019X	 - 021298
	HD 7/2 DG-10		EK50021	 - 021299-
	HD 7/2 DG-10		32019X	 - 021299-
	HD 7/5 DG-10		33021	 - 021298
	HD 7/5 DG-10		32019X	 - 021298
	HD 7/5 DG-10		EK50021	 - 021299-
	HD 7/5 DG-10		32019X	 - 021299-
	HL 4/06 D-12		33020	
	HL 4/06 D-12		33117	
	HL 7/013 D-16		33022	
	HL 7/015 D-13		33022	 - 021298
	HL 7/015 D-13		30220	 - 021298
	HL 7/015 D-13		33022	 - 021299-
	HL 7/015 D-13		30220	 - 021299-
	HL 7/015 DL-13		33022	 - 021298
	HL 7/015 DL-13		30220	 - 021298
	HL 7/015 DL-13		33022	 - 021299-
	HL 7/015 DL-13		30220	 - 021299-
	HL 7/18 D-13		33022	 - 021298
	HL 7/18 D-13		30220	 - 021298
	HL 7/18 D-13		33022	 - 021299-
	HL 7/18 D-13		30220	 - 021299-
	HL 7/3 D-10		33021	 - 021298
	HL 7/3 D-10		32019X	 - 021298
	HL 7/3 D-10		EK50021	 - 021299-
	HL 7/3 D-10		32019X	 - 021299-
	HL 7/4 D-10		33021	 - 021298
	HL 7/4 D-10		32019X	 - 021298
	HL 7/4 D-10		EK50021	 - 021299-
	HL 7/4 D-10		32019X	 - 021299-
	NR 4/11 DL-7.5		EK50011	
	NR 4/11 DL-7.5		32310	
	NS 4/11 D-10		33019	
	NS 4/11 D-10		33215	
SK 3300 SERIES				
	AL 7/1 D-7	XGA32021X/Y32021X		
	AL 7/1 D-7	32019X		
	VD 4/20 DL-7.5	EK50011		
	VD 4/20 DL-7.5	32310		
	VL 4/10 D-7	EK50011		
	VL 4/10 D-7	32310		
	VL 4/15 D-7.5	32314		
	VL 4/15 D-7.5	32310		
	VL 4/16 D-7.5	32314		
	VL 4/16 D-7.5	32310		
	VL 4/16 D-7.5	32314		
	VL 4/20 DL-7.5	32314		
	VL 4/20 DL-7.5	32310		



































APPLICATION LISTINGS - TRUCK



MERCEDES-BENZ											
SK 3300 SERIES ...											
	VL 4/27 D-7.5	32310									
	VL 5/1 D-9	32311									
	VL 5/1 D-9	32311									
	VL 5/2 D-9	JH415647/10									
	VL 5/2 D-9	32311									
	VL 5/20 DC-9	32311									
	VL 5/20 DC-9	32311									
	VL 5/21 DC-9	32311									
	VL 5/21 DC-9	32311									
	HD 7/016 DG-13		33022								021298
	HD 7/016 DG-13		30220								021298
	HD 7/016 DG-13		33022								021299-
	HD 7/016 DG-13		30220								021299-
	HD 7/19 DG-13		33022								021298
	HD 7/19 DG-13		30220								021298
	HD 7/19 DG-13		33022								021299-
	HD 7/19 DG-13		30220								021299-
	HD 7/19 DG-13		33022								021299-
	HD 7/19 DG-13		30220								021299-
	HD 7/2 DG-10		33021								021298
	HD 7/2 DG-10		32019X								021298
	HD 7/2 DG-10		EK50021								021299-
	HD 7/2 DG-10		32019X								021299-
	HL 7/015 D-13		33022								021298
	HL 7/015 D-13		30220								021298
	HL 7/015 D-13		33022								021299-
	HL 7/015 D-13		30220								021299-
	HL 7/016 DG-13		33022								021298
	HL 7/016 DG-13		30220								021298
	HL 7/016 DG-13		33022								021299-
	HL 7/016 DG-13		30220								021299-
	HL 7/18 D-13		33022								021298
	HL 7/18 D-13		30220								021298
	HL 7/18 D-13		33022								021299-
	HL 7/18 D-13		30220								021299-
	HL 7/3 D-10		33021								021298
	HL 7/3 D-10		32019X								021298
	HL 7/3 D-10		EK50021								021299-
	HL 7/3 D-10		32019X								021299-
SK 3500 SERIES											
	AL 7/1 D-7	XGA32021X/Y32021X									
	AL 7/1 D-7	32019X									
	VL 4/10 D-7	EK50011									
	VL 4/10 D-7	32310									
	VL 4/15 D-7.5	32314									
	VL 4/15 D-7.5	32310									
	VL 4/16 D-7.5	32314									
	VL 4/16 D-7.5	32310									
	VL 4/20 DL-7.5	32314									
	VL 4/20 DL-7.5	32310									
	VL 4/23 D-6.7	EK50011									
	VL 4/23 D-6.7	32310									
	VL 4/24 D-6.7	EK50011									
	VL 4/24 D-6.7	32310									
	VL 4/25 DL-6.7	EK50011									

APPLICATION LISTINGS - TRUCK









					
MERCEDES-BENZ					
SK 3500 SERIES ...					
	VL 4/25 DL-6.7	32310			
	VL 4/27 D-7.5	32314			
	VL 4/27 D-7.5	32310			
	VL 4/28 D-7.5	32314			
	VL 4/28 D-7.5	32310			
	VL 4/29 D-7.5	32314			
	VL 4/29 D-7.5	32310			
	VL 4/31 DL-7.5	32314			
	VL 4/31 DL-7.5	32310			
	VL 5/1 D-9	JH415647/10			
	VL 5/1 D-9	33211			
	VL 5/2 D-9	JH415647/10			
	VL 5/2 D-9	33211			
	VO 4/22 DLE-6.6	EK50011			
	VO 4/22 DLE-6.6	32310			
	HD 7/014 DGS-16		33022		
	HD 7/016 DG-13		33022		 - 021298
	HD 7/016 DG-13		30220		 - 021298
	HD 7/016 DG-13		33022		 021299-
	HD 7/016 DG-13		30220		 021299-
	HD 7/19 DG-13		33022		 - 021298
	HD 7/19 DG-13		30220		 - 021298
	HD 7/19 DG-13		33022		 021299-
	HD 7/19 DG-13		30220		 021299-
	HL 7/013 D-16		33022		
	HL 7/015 D-13		33022		 - 021298
	HL 7/015 D-13		30220		 - 021298
	HL 7/015 D-13		33022		 021299-
	HL 7/015 D-13		30220		 021299-
	HL 7/015 DL-13		33022		 - 021298
	HL 7/015 DL-13		30220		 - 021298
	HL 7/015 DL-13		33022		 021299-
	HL 7/015 DL-13		30220		 021299-
	HL 7/016 DG-13		33022		 - 021298
	HL 7/016 DG-13		30220		 - 021298
	HL 7/016 DG-13		33022		 021299-
	HL 7/016 DG-13		30220		 021299-
	HL 7/18 D-13		33022		 - 021298
	HL 7/18 D-13		30220		 - 021298
	HL 7/18 D-13		33022		 021299-
	HL 7/18 D-13		30220		 021299-
	NR 4/11 DL-7.5		EK50011		
	NR 4/11 DL-7.5		32310		
SK 3600 SERIES					
	VD 4/20 DL-7.5	32314			
	VD 4/20 DL-7.5	32310			
	VL 4/10 D-7	EK50011			
	VL 4/10 D-7	32310			
	VL 4/16 D-7.5	32314			
	VL 4/16 D-7.5	32310			
	HD 7/19 DG-13		33022		 - 021298
	HD 7/19 DG-13		30220		 - 021298
	HD 7/19 DG-13		33022		 021299-
	HD 7/19 DG-13		30220		 021299-

APPLICATION LISTINGS - TRUCK











A

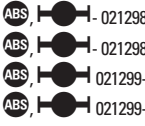

     	
MERCEDES-BENZ	
SK 3800 SERIES	
VD 4/20 DL-7.5 VD 4/20 DL-7.5 VL 4/16 D-7.5 VL 4/16 D-7.5 HD 7/014 DG-16 HD 7/014 DGS-16 HL 7/013 D-16	32314 32310 32314 32310 33022 33022 33022
SK 4000 SERIES	
VL 4/10 D-7 VL 4/10 D-7 VL 4/16 D-7.5 VL 4/16 D-7.5 HD 7/013 D-16 HD 7/014 DGS-16 HD 7/016 DG-13 HD 7/016 DG-13 HD 7/016 DG-13 HD 7/016 DG-13 HL 7/015 D-13 HL 7/015 D-13 HL 7/015 D-13 HL 7/015 D-13	EK50011 32310 32314 32310 33022 33022 33022 30220 33022 30220 33022 30220 33022 30220 33022 30220
SK 4100 SERIES	
VL 4/27 D-7.5 VL 4/27 D-7.5 VL 4/53 DC-7.5 VL 4/53 DC-7.5 VL 4/55 D-7.5 VL 4/55 D-7.5 VL 5/1 D-9 VL 5/1 D-9 HD 4/02 GD-10 HD 4/02 GD-10 HD 4/03 D-10 HD 4/03 D-10 HD 7/016 DG-13 HD 7/016 DG-13 HD 7/016 DG-13 HD 7/016 DG-13 HL 7/015 D L-13 HL 7/015 D L-13 HL 7/015 D L-13 HL 7/015 D L-13	32314 32310 32314 32310 32314 32310 32311 32311 33020 33117 33020 33117 33022 30220 33022 30220 33022 30220 33022 30220
SK 4400 SERIES	
AL 7/1 D-7 AL 7/1 D-7 VL 4/10 D-7 VL 4/10 D-7 VL 4/15 D-7.5 VL 4/15 D-7.5 VL 4/16 D-7.5	XGA32021X/Y32021X 32019X EK50011 32310 32314 32310 32314

APPLICATION LISTINGS - TRUCK

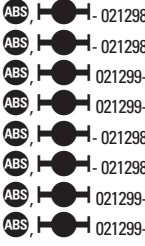























					
MERCEDES-BENZ					
SK 4400 SERIES ...					
	VL 4/16 D-7.5 VL 4/25 DL-6.7 VL 4/25 DL-6.7 VL 4/27 D-7.5 VL 4/27 D-7.5 VL 4/28 D-7.5 VL 4/28 D-7.5 VL 5/1 D-9 VL 5/1 D-9 VL 5/2 D-9 VL 5/2 D-9 HD 7/016 DG-13 HD 7/016 DG-13 HD 7/016 DG-13 HD 7/016 DG-13	32310 EK50011 32310 32314 32310 32314 32310 JH415647/10 33211 JH415647/10 33211	33022 30220 33022 30220		
SK 4800 SERIES					
	VL 4/10 D-7 VL 4/10 D-7 VL 4/15 D-7.5 VL 4/15 D-7.5 VL 4/16 D-7.5 VL 4/16 D-7.5 VL 4/27 D-7.5 VL 4/27 D-7.5 VL 5/1 D-9 VL 5/1 D-9 VL 5/2 D-9 VL 5/2 D-9 HD 7/016 DG-13 HD 7/016 DG-13 HD 7/016 DG-13 HD 7/016 DG-13 HL 7/015 D-13 HL 7/015 D-13 HL 7/015 D-13 HL 7/015 D-13	EK50011 32310 32314 32310 32314 32310 32314 32310 JH415647/10 33211 JH415647/10 33211	33022 30220 33022 30220 33022 30220 33022 30220 33022 30220		
SK 5000 SERIES					
	VL 4/10 D-7 VL 4/10 D-7 VL 4/15 D-7.5 VL 4/15 D-7.5 VL 4/16 D-7.5 VL 4/16 D-7.5 VL 4/23 D-6.7 VL 4/23 D-6.7 VL 4/24 D-6.7 VL 4/24 D-6.7 VL 4/27 D-7.5 VL 4/27 D-7.5 VL 4/28 D-7.5 VL 4/28 D-7.5 VL 5/1 D-9	EK50011 32310 32314 32310 32314 32310 EK50011 32310 EK50011 32310 32314 32310 32314 32310 JH415647/10			



















APPLICATION LISTINGS - TRUCK



				 			
MERCEDES-BENZ							
SK 5000 SERIES ...							
	VL 5/1 D-9	33211					
	VL 5/2 D-9	JH415647/10					
	VL 5/2 D-9	33211					
	HD 7/014 DGS-16		33022				
	HD 7/016 DG-13		33022				- 021298
	HD 7/016 DG-13		30220				- 021298
	HD 7/016 DG-13		33022				021299-
	HD 7/016 DG-13		30220				021299-
	HD 7/19 DG-13		33022				- 021298
	HD 7/19 DG-13		30220				- 021298
	HD 7/19 DG-13		33022				021299-
	HD 7/19 DG-13		30220				021299-
	HL 7/015 DL-13		33022				- 021298
	HL 7/015 DL-13		30220				- 021298
	HL 7/015 DL-13		33022				021299-
	HL 7/015 DL-13		30220				021299-
	HL 7/18 D-13		33022				- 021298
	HL 7/18 D-13		30220				- 021298
	HL 7/18 D-13		33022				021299-
	HL 7/18 D-13		30220				021299-
SK 6000 SERIES							
	VL 4/10 D-7	EK50011					
	VL 4/10 D-7	32310					
	VL 4/15 D-7.5	32314					
	VL 4/15 D-7.5	32310					
	VL 4/16 D-7.5	32314					
	VL 4/16 D-7.5	32310					
T2 600 SERIES							
	VL 1/3-2.1	2789/2720					-Ch.48630
	VL 1/3-2.1	1380/1328					-Ch.48630
	VL 1/3-2.1	33109					Ch.48631-
	VL 1/3-2.1	33205					Ch.48631-
	VL 1/5-2.3	33109					
	VL 1/5-2.3	33205					
	VL 1/6-2.3	33109					
	VL 1/6-2.3	33205					
	VL 1/7-2.6	33109					
	VL 1/7-2.6	33205					
	VL 1/9 C-2.3	33109					
	VL 1/9 C-2.3	33205					
	VL 2/5-2.2	32011X					
	VL 2/5-2.2	32206					
	VL 2/6-3.1	33111					
	VL 2/6-3.1	32306					
	HL 0/6-3.9		32012X				
	HL 0/6-3.9		32210				
	HL 1/3-4.5		33895/33822				
	HL 1/3-4.5		3984/3920				
	HL 1/8-4.7		32014X				
	HL 1/8-4.7		32011X				
	HL 2/15-5/8		33011				
	HL 2/2 L-4.8		3984/3920				



APPLICATION LISTINGS - TRUCK

		 	 	
MERCEDES-BENZ				
T2 600 SERIES ...				
	HL 2/2 L-4.8 HL 2/2-4.8 HL 2/2-4.8 HL 2/5-4.5 HL 2/5-4.5 HL 2/9-4.7 HL 2/9-4.7		33895/33822 3984/3920 33895/33822 3984/3920 33895/33822 3984/3920 33895/33822	
NISSAN				
M 100.1/2				
		32307	33015	
M 110/125/125 T				
		30210 32307	33015	
M 125.1				
		30210 32307	33015	
M 130/130 HD, M 140				
		HM212044/10 3880/3820	33115	
MF 100/108				
		30209 30209	30206 30205	
MF 260/265				
		25590/25520 LM67048/10	27687/27620 395A/394A	
P 137				
		HM212044/10 3880/3820	580/572 560/552A	
P 160/170 T				
		H414245X/10 455/453X	32219 30218	



APPLICATION LISTINGS - TRUCK









A



NISSAN							
P 200/260/270/320							
		6461A/6420 32310		32219 30218			
RENAULT RVI							
75.130/85.150/85.130 [4X4]							
	SINPAR/MD 3000 SINPAR/MD 3000 SINPAR/MD 3000 SINPAR/MD 3000 SINPAR/MD 4000 SINPAR/MD 4000 3 MRDIF 155/156/158/171/214 3 MRDIF 155/156/158/171/214 3 MRDIF 216/219 3 MRDIF 216/219 3 MRDIF 8274 3 MRDIF 8274 3 MRDIS 8500 FW 3 MRDIS 8500 FW P 620 D1 P 620 F P 620 F P 1021 K P 1021 K	33015 32015X 33014 32014X 32018X 32018X 32017X 32015X 32017X 32015X 32017X 32015X 32017X 32017X 32017X 32017X 32017X		33014 33018 33015 594/593X 32217			6 M75, - 05/91 6 M75, - 05/91 6 M70, - 05/91 6 M70, - 05/91 -05/91 -05/91 -05/91 -05/91 -05/91 -05/91 -05/91 -05/91 -05/91 -05/91 -05/91 -05/91 -05/91 -05/91 -05/91 -05/91
85.150 [4X4]							
	E 408-5 E 408-5 P 821/P 1021 P 821/P 1021	33211 33208		594/593X 594/593X			
90 B6/B6A/B6Z/B7							
	669-01 669-01 70 HD 70 HD	33209 32206 33209 33206		33014 33012 33014 33012			-14/06/85 -14/06/85 17/06/85 - 17/06/85 -
90 B 8							
	401 401 SOMA 95 SOMA 95	32210 32207		33015 33013			

APPLICATION LISTINGS - TRUCK















						
RENAULT RVI						
110.130 [6X6]						
	MDRFP 4000 MDRFP 4000 MDRFP 4000 MDRFP 4000	33014 32014X		33014 32014X		
110.150 [4X4]						
	E 408-5 E 408-5 SINPAR MD 3000 SINPAR MD 3000 SINPAR MD 3000 SINPAR MD 3000 SINPAR MD 4000 SINPAR MD 4000 3 MRDIF 155/156/158/171/214 3 MRDIF 155/156/158/171/214 3 MRDIF 216/219 3 MRDIF 216/219 3 MRDIF 8274 3 MRDIF 8274 3 MRDIS 8500 FW 3 MRDIS 8500 FW P 620 D1 P 620 F P 620 F P 821/P 1021 P 821/P 1021 P 1021 K P 1021 K	33211 33208 33015 32015X 33014 32014X 32018X 32018X 32017X 32015X 32017X 32015X 32017X 32015X 32017X 32017X 32017X 32017X 32017X		33014 33018 33015 594/593X 594/593X 594/593X 32217		6 M75, - 05/91 6 M75, - 05/91 6 M70, - 05/91 6 M70, - 05/91 -05/91 -05/91 -05/91 -05/91 -05/91 -05/91 -05/91 -05/91 -05/91 -05/91 -05/91 -05/91 -05/91 -05/91 -05/91 -05/91
110.170 [4X4]						
	E 408-5 E 408-5 SINPAR MD 3000 SINPAR MD 3000 SINPAR MD 3000 SINPAR MD 3000 SINPAR MD 4000 SINPAR MD 4000 3 MRDIF 155/156/158/171/214/216/219 3 MRDIF 155/156/158/171/214/216/219 3 MRDIF 8274 3 MRDIF 8274 3 MRDIS 8500 FW 3 MRDIS 8500 FW P 620 D1 P 620 F P 620 F P 821/P 1021 P 821/P 1021 P 1021 K P 1021 K	33211 33208 33015 32015X 33014 32014X 32018X 32018X 32017X 32015X 32017X 32015X 32017X 32017X 32017X 32017X		33014 33018 33015 594/593X 594/593X 594/593X 32217		6 M75, - 05/91 6 M75, - 05/91 6 M70, - 05/91 6 M70, - 05/91 -05/91 -05/91 -05/91 -05/91 -05/91 -05/91 -05/91 -05/91 -05/91 -05/91 -05/91 -05/91 -05/91 -05/91 -05/91



APPLICATION LISTINGS - TRUCK













A



     					
RENAULT RVI					
130 B6/B6A/B9/B9A					
	401 401 SOMA 95 SOMA 95	32210 32207	33015 33013		
130 B11/B13/B14, 150 B11/B13					
	15 M/15 MHD/17 M 15 M/15 MHD/17 M 467-26 467-26 P 620 F/F1 P 620 F/F1 P 821 F/F1 P 821 F/F1	32211 32208	33018 33015 33018 33015 33018 33015 594/593X 594/593X		-12/92 -12/92 -12/92 -12/92
770 KB 6					
	E3A-10 E3A-10 E3A-11 E3A-11 P 620 D1 P 621 B1	33212 33109 33212 33109	33014 594/593X		
AE 380/385 T I/390 MAGNUM					
	E 81 E 81 1341 1341 1345 840 A 840 A	EK50042 EK50042	JF9549/10 33216 JF9549/10 32019X 33117		-01/93 -01/93
AE 420 T I/430 MAGNUM					
	E 81 E 81 1341 1341 1345 840 A 840 A	EK50042 EK50042	JF9549/10 33216 JF9549/10 32019X 33117		-01/93 -01/93
AE 470 MAGNUM					
	E 81 E 81 1345	EK50042 EK50042	JF9549/10		-01/93 -01/93
AE 500/520/560 MAGNUM					
	E 81 E 81 1341 1341 1345	EK50042 EK50042	JF9549/10 33216 JF9549/10		-01/93 -01/93



APPLICATION LISTINGS - TRUCK













							
RENAULT RVI							
AE 500/520/560 MAGNUM ...							
	840 A 840 A			32019X 33117			
B 70							
	369 369 369 369 569-39 569-39	33108 33205 32008X 30205		32011X 32010X			18/11/85 - 18/11/85 - -15/11/85 -15/11/85
B 80							
	569-01-39 569-01-39	33108 33205 33108 32305		32011X 32010X			-17/11/93 -17/11/93 18/11/93 - 18/11/93 - -08/93 -08/93
B 90							
	369 369 569-39 569-39 669-02 669-02	32008X 30205		32011X 32010X 33014 33012			
B 110 [4X2]							
	569-01-39 569-01-39	33108 33205 33108 32305		32011X 32010X			-17/11/93 -17/11/93 18/11/93 - 18/11/93 - -08/93 -08/93
B 110 [4X4]							
	569-10 569-10 669-04 669-04 669-04 669-04	32013X 32011X 32012X 32010X		33013 32011X 33014 33012			-08/93 -08/93 09/93 - 09/93 - -08/93 -08/93 09/93 - 09/93 -
B 120							
	569-01-39 569-01-39	33108 33205 33108 32305		32011X 32010X			-17/11/93 -17/11/93 18/11/93 - 18/11/93 - -08/93 -08/93





APPLICATION LISTINGS - TRUCK

















 		 			
RENAULT RVI					
CE 160 MAROC					
	E 400-04/14 E 408-05/13/15/24	33211 33208			
C 210					
	E6A-4C E6A-4C E6A-4C P 1332 P 1332	33214 33209 33214	JHM720249/10 64432/64708		-14/03/84 -14/03/84 15/03/84 -
C 230/C 260/C 280/C 290 [4X2] [4X4]					
	E6A-4C E6A-711 PA-721 B PA-721 B P 1332 P 1332	33214 33214 594/593X 594/593X	JHM720249/10 64432/64708		15/03/84 - 15/03/84 -
C 260/C 280/C 290 [6X4]					
	E5A-4E E5A-4E E5A-4E E5A-4E E6A-4C E6A-4C E6A-4C E6A-711 PMA/PR 1141-A PMA/PR 1321 PMA/PR 1321 PMA/PR 1341 PMA/PR 1341	33213 33210 33213 33210 33214 33209 33214 33214	32019X 683/672 52375/52618 JF9549/10 33216		- 03/93 - 03/93 04/93 - 04/93 - -14/03/84 -14/03/84 15/03/84 - 15/03/84 -
C 300/C 340 TI [4X2] [4X4]					
	E6A-4C E6A-4C E6A-4C E6A-711 PA-721 B PA-721 B P 1332 P 1332	33214 33209 33214 33214 594/593X 594/593X	JHM720249/10 64432/64708		-14/03/84 -14/03/84 15/03/84 - 15/03/84 -
C 300/C 340 TI [6X4]					
	E5A-4E E5A-4E E5A-4E E5A-4E E6A-4C E6A-4C E6A-4C E6A-711 PMA/PR 1141-A PMA/PR 1321	33213 33209 33213 33210 33214 33209 33214 33214	32019X 683/672		-03/93 -03/93 04/93 - 04/93 - -14/03/84 -14/03/84 15/03/84 - 15/03/84 -



APPLICATION LISTINGS - TRUCK



















							
RENAULT RVI							
C 300/C 340 TI [6X4] ...							
	PMA/PR 1321 PMA/PR 1341 PMA/PR 1341			52375/52618 JF9549/10 33216			
CBH 280/340/350/380 [6X4]							
	E6A P/PMA 1532 P/PMA 1532	33214		JHM720249/10 64432/64708			
CBH 280/340/350 [6X6]							
	PA-721 PA-721 P/PMA 1532 P/PMA 1532	594/593X 32217		JHM720249/10 64432/64708			
CBH 320/385 [6X4]							
	E6B-811 P/ PMA 1532-01 P/ PMA 1532-01	33214		JHM720249/10 64432/64708			
CBH 320/385 [6X6]							
	PA-721-02 PA-721-02 P/ PMA 1532-01 P/ PMA 1532-01	594/593X 32217		JHM720249/10 64432/64708			
CLM 280/340/350/380							
	E6A-511 P 1532-11/12 P 1532-11/12	33214		JHM720249/10 64432/64708			
CLM 320/385 [4X2]							
	E6A-511/811 P 1532-01/11 P 1532-01/11	33214		JHM720249/10 64432/64708			
CLR 220 [4X2]							
	E6A-711 P 1332 P 1332	33214		JHM720249/10 64432/64708			
CLR 220 [4X4]							
	PA-721 B PA-721 B P 1332 P 1332	594/593X 32217		JHM720249/10 64432/64708			
CLR 230							
	E5A E5A E5A E5A E6A	33213 33209 33213 33210 33214					-03/93 -03/93 04/93 - 04/93 -



APPLICATION LISTINGS - TRUCK































				 			
RENAULT RVI							
CLR 230 ...							
	P 1332 P 1332 PMA/PR 1141-A PMA/PR 1341 PMA/PR 1341			JHM720249/10 64432/64708 32019X JF9549/10 33216			
G 170-11/13/15							
	E4A E4A E5A-921 E5A-921 E5A E5A P 1141 P 1141	33212 33109 33213 33209 33213 33209		JF9549/10 33216			-09/84 -09/84 -01/86 -01/86 02/86 - 02/86 -
G 170-16/17							
	E5A E5A E5A E5A P 1141 P 1141	33213 33209 33213 33209		JF9549/10 33216			-01/86 -01/86 02/86 - 02/86 -
G 200							
	E5 E5 E5 E5 E5 E6 E6 E6 P 1140 P 1140 P 1141/P 1341 P 1141/P 1341 P 1332 P 1332 P 1345	33213 33209 33213 33209 33213 33209 33214 33214 33214		JF9549/10 33117 JF9549/10 33216 JHM720249/10 64432/64708 JF9549/10			-08/91  -08/91  - 08/91  - 08/91  09/91-03/93 09/91-03/93 -08/91  - 08/91  09/91-
G 210							
	E5A-4C E5A-4C E5A-4C E5A-4C E5A -23 E5A -23 E5A-821 E5A-821 E5A-821 E5A-821 E5A-921	33213 33209 33213 33209 33213 33209 33213 33209 33213 33209 33213					-01/86 -01/86 02/86- 02/86- -02/86 -02/86 03/86- 03/86- -12/87



















APPLICATION LISTINGS - TRUCK



					
RENAULT RVI					
G 210 ...					
	E5A-921	33209			-12/87
	E6A-4D	33214			-14/03/84
	E6A-4D	33209			-14/03/84
	E6A-4D	33214			15/03/84-
	P 1141/P 1341		JF9549/10		
	P 1141/P 1341		33216		
	P 1332		JHM720249/10		
	P 1332		64432/64708		
G 210 MANAGER					
	E5	33213			-08/91
	E5	33209			-08/91
	E5	33213			- 08/91
	E5	33209			- 08/91
	E5	33213			09/91-03/93
	E5	33209			09/91-03/93
	E6	33214			-08/91
	E6	33214			- 08/91
	E6	33214			09/91 -
	P 1140		JF9549/10		
	P 1140		33117		
	P 1141/P 1341		JF9549/10		
	P 1141/P 1341		33216		
	P 1332		JHM720249/10		
	P 1332		64432/64708		
	P 1345		JF9549/10		
G 220 BOM					
	E5A-23	33213			-08/91
	E5A-23	33209			-08/91
	E5A-23	33213			09/91-03/93
	E5A-23	33209			09/91-03/93
	E5A-23	33213			04/93 -
	E5A-23	33210			04/93 -
	E5B-4C	33213			-08/91
	E5B-4C	33209			-08/91
	E5B-4C	33213			- 08/91
	E5B-4C	33209			- 08/91
	E5B-4C	33213			09/91-03/93
	E5B-4C	33209			09/91-03/93
	E5B-4C	33213			04/93 -
	E5B-4C	33210			04/93 -
	E6B-4D	33214			-08/91
	E6B-4D	33214			- 08/91
	E6B-4D	33214			09/91 -
	P 1341 C		JF9549/10		
	P 1341 C		33216		
	P 1332		JHM720249/10		
	P 1332		64432/64708		
	P 1345		JF9549/10		
G 230					
	E5A-4C	33213			-01/86
	E5A-4C	33209			-01/86

APPLICATION LISTINGS - TRUCK



 		 			
RENAULT RVI					
G 230 ...					
	E5A-4C	33213			02/86 -
	E5A-4C	33209			02/86 -
	E5A -23	33213			
	E5A -23	33209			
	E5A-821	33213			-02/86
	E5A-821	33209			-02/86
	E5A-821	33213			03/86 -
	E5A-821	33209			03/86 -
	E5A-921	33213			-12/87
	E5A-921	33209			-12/87
	E6A-4D	33214			-14/03/84
	E6A-4D	33209			-14/03/84
	E6A-4D	33214			15/03/84 -
	P 1141/P 1341		JF9549/10		
	P 1141/P 1341		33216		
	P 1332		JHM720249/10		
	P 1332		64432/64708		
G 230 INCENDIE					
	E5A-4C	33213			-03/93
	E5A-4C	33209			-03/93
	E5A-4C	33213			04/93 -
	E5A-4C	33210			04/93 -
	E5A-921	33213			
	E5A-921	33209			
	P 1141		JF9549/10		
	P 1141		33216		
G 230 TI					
	E5	33213			-08/91 
	E5	33209			-08/91 
	E5	33213			- 08/91 
	E5	33209			- 08/91 
	E5	33213			09/91-03/93
	E5	33209			09/91-03/93
	E6	33214			-08/91 
	E6	33214			- 08/91 
	E6	33214			09/91 -
	P 1140		JF9549/10		
	P 1140		33117		
	P 1141/P 1341		JF9549/10		
	P 1141/P 1341		33216		
	P 1332		JHM720249/10		
	P 1332		64432/64708		
	P 1345		JF9549/10		
G 235 MAXTER [4X2]					
		EK50042			
		EK50042			
	P 1541 A		JF9549/10		
	P 1541 A		33216		
	P 1545 A		JF9549/10		



APPLICATION LISTINGS - TRUCK



RENAULT RVI											
G 260 [11/13]											
	E4A	33212									
	E4A	33109									
	E5A	33213									
	E5A	33209									
	P 1141				JF9549/10						
	P 1141				33216						
G 260 [15 T]											
	E4A	33212									
	E4A	33109									
	E5A	33213									
	E5A	33209									
	P 1141				JF9549/10						
	P 1141				33216						
G 260 [16/17 T]											
	E5A	33213									
	E5A	33209									
	E5A-4C	33213									
	E5A-4C	33209									
	P 1141				JF9549/10						
	P 1141				33216						
G 260 [19 T]											
	E5A	33213									
	E5A	33209									
	E5A-821	33213									
	E5A-821	33209									
	E6A	33214									
	E6A	33209									
	E6A	33214									
	P 1141/P 1341				JF9549/10						
	P 1141/P 1341				33216						
	P 1332				JHM720249/10						
	P 1332				64432/64708						
G 260 [22 T]											
	E5A	33213									
	E5A	33209									
	P 1141				JF9549/10						
	P 1141				33216						
G 260 [26 T]											
	E5A	33213									
	E5A	33209									
	E6A	33214									
	E6A	33209									
	E6A	33214									
	P/PR 1341				JF9549/10						
	P/PR 1341				33216						



APPLICATION LISTINGS - TRUCK





































































































































A



RENAULT RVI							
G 270 BOM							
	E5A-23	33213					-08/91
	E5A-23	33209					-08/91
	E5A-23	33213					09/91-03/93
	E5A-23	33209					09/91-03/93
	E5A-23	33213					04/93 -
	E5A-23	33210					04/93 -
	E5B-4C	33213					-08/91
	E5B-4C	33209					-08/91
	E5B-4C	33213					- 08/91
	E5B-4C	33209					- 08/91
	E5B-4C	33213					09/91-03/93
	E5B-4C	33209					09/91-03/93
	E5B-4C	33213					04/93 -
	E5B-4C	33210					04/93 -
	E6B-4D	33214					-08/91
	E6B-4D	33214					- 08/91
	E6B-4D	33214					09/91 -
	P 1341 C		JF9549/10				
	P 1341 C		33216				
	P 1332		JHM720249/10				
	P 1332		64432/64708				
	P 1345		JF9549/10				
G 270 INCENDIE							
	E5A-4C	33213					-03/93
	E5A-4C	33209					-03/93
	E5A-4C	33213					
	E5A-4C	33210					
	E5A-921	33213					
	E5A-921	33209					
	P 1141		JF9549/10				
	P 1141		33216				
G 270/280 MANAGER [4X2] [6X2/4]							
	E5A-23	33213					-08/91
	E5A-23	33209					-08/91
	E5A-23	33213					09/91-03/93
	E5A-23	33209					09/91-03/93
	E5A-23	33213					04/93 -
	E5A-23	33210					04/93 -
	E5A-4C/E5B-4C	33213					-08/91
	E5A-4C/E5B-4C	33209					-08/91
	E5A-821	33213					-08/91
	E5A-821	33209					-08/91
	E5A-4C/E5B-4C	33213					- 08/91
	E5A-4C/E5B-4C	33209					- 08/91
	E5A-821	33213					- 08/91
	E5A-821	33209					- 08/91
	E5A-4C/E5B-4C	33213					09/91-03/93
	E5A-4C/E5B-4C	33209					09/91-03/93
	E5A-821	33213					09/91-03/93
	E5A-821	33209					09/91-03/93
	E5A-4C/E5B-4C	33213					04/93 -
	E5A-4C/E5B-4C	33210					04/93 -

APPLICATION LISTINGS - TRUCK























































					
RENAULT RVI					
G 270/280 MANAGER [4X2] [6X2/4] ...					
	E5A-821 E5A-821 E6A-4D E6B-4D E6A/E6 B E6A/E6 B E6A/E6 B P 1141/ P 1341 P 1141/ P 1341 P 1332 P 1332 P 1142/ P 1345	33213 33210 33214 33214 33214 33214 33214 33214	JF9549/10 33216 JHM720249/10 64432/64708 JF9549/10	                                             	04/93 - 04/93 - -08/91  -08/91  09/91 - -08/91 -08/91
G 270/280 MANAGER [4X4]					
	PA 721 B PA 721 B P 1141/ P 1341 P 1141/ P 1341 P 1332 P 1332 P 1142/ P 1345	594/593X 32217	JF9549/10 33216 JHM720249/10 64432/64708 JF9549/10	                                 	-08/91 -08/91
G 270/280 MANAGER [6X2] [6X4] [8X4]					
	E5A-821 E5A-821 E5A-821 E5A-821 E5A-821 E5A-821 E5A-821 E5A-821 E5A-821 E5A-821 E5A-821 E5A-821 E5A-821 E6A-4D/E6B-4D E6A/E6B E6A/E6B E6A/E6B PR/PMA 1141 A P 1332 P 1332 PMA 1341 PMA 1341 P 1345	33213 33209 33213 33209 33213 33209 33213 33209 33213 33209 33213 33209 33213 33209 33214 33214 33214 33214 33214 32019X JHM720249/10 64432/64708 JF9549/10 33216 JF9549/10	JF9549/10 33216 JHM720249/10 64432/64708 JF9549/10 33216 JF9549/10	                          	-08/91  -08/91  -08/91  -08/91  09/91 - 03/93  09/91 - 03/93  -03/93  -03/93  -03/93  -03/93  04/93 - 04/93 - -08/91  -08/91  09/91 -
G 290 16/17 T					
	E5A E5A E5A-4C E5A-4C P 1141 P 1141	33213 33209 33213 33209	JF9549/10 33216	     	-01/86 -01/86 02/86 - 02/86 -



























APPLICATION LISTINGS - TRUCK



     					
RENAULT RVI					
G 290 [VTL] [6x4]					
	E6A E6A P 1141 P 1141	33214 33214	JF9549/10 33216		
G 290 19 T					
	E5A-23 E5A-23 E6A E6A E6A P 1332 P 1332 P/PR 1341 P/PR 1341	33213 33209 33214 33209 33214	JHM720249/10 64432/64708 JF9549/10 33216	        	-01/86 -01/86 -14/03/84 -14/03/84 15/03/84 -
G 290 [VTL]					
	E6A-4D PR/PMA 1341 PR/PMA 1341	33214	JF9549/10 33216	  	
G 300 MAXTER [4X2]					
	P 1541 A P 1541 A P 1545 A	EK50042 EK50042	JF9549/10 33216 JF9549/10	    	
G 300 MAXTER [6X4] [8X4]					
	ESS 83 ESS 83 PR/PMA 1141 A PR/PMA 1841 B PR/PMA 1841 B PR/PMA 1845 B	EK50042 EK50042	32019X JF9549/10 33216 JF9549/10	     	09/93 - 09/93 -
G 300/330/340 TI MANAGER [4X2] [6X2] [6X4]					
	E5A-23 E5A-23 E5A-23 E5A-23 E5A-23 E5A-23 E5A-4C/E5B-4C E5A-4C/E5B-4C E5A-821 E5A-821 E5A-4C/E5B-4C E5A-4C/E5B-4C E5A-821 E5A-821 E5A-4C/E5B-4C E5A-4C/E5B-4C E5A-821	33213 33209 33213 33209 33213 33210 33213 33209 33213 33209 33213 33209 33213 33209 33213 33209 33213		              	-08/91 -08/91 09/91-03/93 09/91-03/93 04/93 - 04/93 - -08/91  -08/91  -08/91  -08/91  -08/91  -08/91  -08/91  09/91-03/93 09/91-03/93 09/91-03/93



APPLICATION LISTINGS - TRUCK

					
RENAULT RVI					
G 300/330/340 TI MANAGER [4X2] [6X2] [6X4] ...					
	E5A-821 E5A-4C/E5B-4C E5A-4C/E5B-4C E5A-821 E5A-821 E6A-4D/E6B-4D E6A/E6B E6A/E6B E6A/E6B P 1141/P 1341 P 1141/P 1341 P 1332 P 1332 P 1142 P 1345	33209 33213 33210 33213 33210 33214 33214 33214 33214 P P P P P P	JF9549/10 33216 JHM720249/10 64432/64708 JF9549/10 JF9549/10		09/91-03/93 04/93 - 04/93 - 04/93 - 04/93 - -08/91  - 08/91  09/91 - -08/91
G 300/330/340 TI MANAGER [4X4]					
	PA 721 B PA 721 B P 1141/ P 1341 P 1141/ P 1341 P 1332 P 1332 P 1142/ P 1345	594/593X 32217	JF9549/10 33216 JHM720249/10 64432/64708 JF9549/10		
G 300/330/340 TI MANAGER [6X2] [6X4] [8X4]					
	E5A-821 E5A-821 E5A-821 E5A-821 E5A-821 E5A-821 E5A-821 E5A-821 E5A-821 E5A-821 E5A-821 E5A-821 E5A-821 E5A-821 E5A-821 E6A-4D E6B-4D E6A/E6B E6A/E6B E6A/E6B PR/PMA 1141 A P 1332 P 1332 PMA 1341 PMA 1341 P 1345	33213 33209 33213 33209 33213 33209 33213 33209 33213 33209 33213 33209 33213 33209 33213 33214 33214 33214 33214 33214 P P P P P	32019X JHM720249/10 64432/64708 JF9549/10 33216 JF9549/10		- 08/91  - 08/91  - 08/91  - 08/91  09/91 - 03/93  09/91 - 03/93  - 03/93  - 03/93  - 03/93  - 03/93  04/93 - 04/93 - -08/91  - 08/91  09/91 -
G 320-19 [VF6-BA]					
	E6A-4D P 1332 P 1332	33214	JHM720249/10 64432/64708		





APPLICATION LISTINGS - TRUCK

A















RENAULT RVI							
G 320-19 T [VF6-BG]							
	E5A-821 E5A-821 P 1332 P 1332	33213 33209		JHM720249/10 64432/64708			
G 340 TI MAXTER [4X2]							
	P 1541 A P 1541 A P 1545 A	EK50042 EK50042		JF9549/10 33216 JF9549/10			
G 340 TI MAXTER [6X4] [8X4]							
	ESS 83 ESS 83 PR/PMA 1141 A PR/PMA 1841 B PR/PMA 1841 B PR/PMA 1845 B	EK50042 EK50042		32019X JF9549/10 33216 JF9549/10		09/93 - 09/93 -	
G 340 TI MAXTER [6X6]							
		JF9549/10		JF9549/10			
GB 131-HR 15							
	E4A E4A P 920-B1/F/G/H P 920-B1/F/G/H P 921-B1/F/G/H P 921-B1/F/G/H	33212 33109		594/593X 665X/653X 594/593X 594/593X			
GB 191/231							
	E4A E4A P 921-B1/F/G/H P 921-B1/F/G/H	33212 33109		594/593X 594/593X			
GBC 180							
	REAR REAR FORWARD REAR			32217 32217			
GBH 260 [4X4]							
	E6A E6A PR/PMA 1032 PR/PMA 1032	33214 33209		JHM720249/10 64432/64708			
GBH 260 [6X6]							
	PKBS 3 PKBS 3 PR/PMA 1032 PR/PMA 1032	32018X 32017X		JHM720249/10 64432/64708			





APPLICATION LISTINGS - TRUCK



					
RENAULT RVI					
GBH 280 [6X4]					
	E6A E6A E6A PR/PMA 1532 PR/PMA 1532	33214 33209 33214	JHM720249/10 64432/64708		-14/03/84 -14/03/84 15/03/84 -
GBH 280 D [6X4]					
	E6 A E6 A E6A-511 PR/PMA 1532 PR/PMA 1532	33214 33209 33214	JHM720249/10 64432/64708		-14/03/84 -14/03/84 15/03/84 -
GBH 280 [6X6]					
	PKBS 3 PKBS 3 PR/PMA 1032 PR/PMA 1032	32018X 32017X	JHM720249/10 64432/64708		
GBH 280 E [6X6]					
	PA 721 PA 721 PR/PMA 1532 PR/PMA 1532	594/593X 32217	JHM720249/10 64432/64708		
GC 191/231, GF 191/231					
	E5A E5A P 1021 P 1021	33213 33209	683/672 52375/52618		
GLC 190					
	E5A E5A P 1021 P 1021 P 1321 P 1321	33213 33209	683/672 52375/52618 683/672 52375/52618		-08/79 -08/79 09/79 - 09/79 -
GLM 280					
	E6A-51 E6A-51 E6A-51 P 1532 P 1532	33214 33209 33214	JHM720249/10 64432/64708		-14/03/84 -14/03/84 15/03/84 -
GLR 190/230					
	E6A E6A E6A P 1332 P 1332	33214 33209 33214	JHM720249/10 64432/64708		-14/03/84 -14/03/84 15/03/84 -











APPLICATION LISTINGS - TRUCK

A



				 			
RENAULT RVI							
GLR 230 [4X4]							
	PA 721 PA 721 PR/PMA 1532 PR/PMA 1532	594/593X 32217		JHM720249/10 64432/64708			
GR 191/231							
	E6A E6A E6A P 1321 P 1321 P 1332 P 1332	33214 33209 33214		683/672 52375/52618 JHM720249/10 64432/64708		-14/03/84 -14/03/84 15/03/84 -	
GR 280/305/350							
	E6A 2/ E6A 31 E6A 2/ E6A 31 P 1332/P 1332 B P 1332/P 1332 B	33214 33209		JHM720249/10 64432/64708			
GRH 235							
	E6A E6A P/PMA 1021 P/PMA 1021	33214 33209		683/672 52375/52618			
GRH 235 R							
	E6A E6A P/PMA 1321 P/PMA 1321	33214 33209		683/672 52375/52618			
GRH 305 [6X4]							
	E6A-21 E6A-21 PMA 1021/PMA 1321 PMA 1021/PMA 1321 P 1032 B/ PMA 1532 P 1032 B/ PMA 1532	33214 33209		683/672 52375/52618 JHM720249/10 64432/64708			
GRH 350 [6X4], GRH 350 TS							
	E6A E6A PMA/PR/P 1021 PMA/PR/P 1021 PMA/PR 1321 PMA/PR 1321 PMA/PR 1032 B PMA/PR 1032 B PMA/P 1532 PMA/P 1532	33214 33209		683/672 52375/52618 683/672 52375/52618 JHM720249/10 64432/64708 JHM720249/10 64432/64708			





APPLICATION LISTINGS - TRUCK



RENAULT RVI					
JK 50/55/60/65/75					
	402	33209			-14/06/85
	402	32206			-14/06/85
	402	33209			17/06/85 -
	402	33206			17/06/85 -
	669		33014		
	669		33012		
	70 HD		33014		
	70 HD		33012		
JN 60/75/85/90/95					
	E 401	32210			
	E 401	32207			
	SOMA 95		33015		
	SOMA 95		33013		
JP 11					
	400	32211			
	400	32208			
	P 620 F		33018		-12/82
	P 620 F		33015		-12/82
	P 620 F1		33018		01/83 -
	P 620 F1		33015		01/83 -
	15 M		33018		
	15 M		33015		
JP 13/A/B/C, JP 14 BOM					
	400	32211			
	400	32208			
	P 820 F		33018		-12/82
	P 820 F		33015		-12/82
	P 820 F1		33018		01/83 -
	P 820 F1		33015		01/83 -
	15 M/MHD, 17 M		33018		
	15 M/MHD, 17 M		33015		
JR 19/21, JX 21					
	400	32211			
	400	32208			
	P 17 M		33018		
	P 17 M		33015		
	P 821 F		594/593X		-12/82
	P 821 F		594/593X		-12/82
	P 821 F1		594/593X		01/83 -
	P 821 F1		594/593X		01/83 -
KERAX					
		EK50042			
		EK50042			
	1141 A		32019X		
	1541 A		JF9549/10		
	1541 A		33216		
	1545 A		JF9549/10		
	1841 B		JF9549/10		
	1841 B		33216		









APPLICATION LISTINGS - TRUCK



RENAULT RVI							
KERAX ...							
	1845 B PA 945		JF9549/10 JT9049/10				
M 140/160							
	E 400	33211				-07/90	
	E 400	33208				-07/90	
	E 400	33211				08/90 -	
	E 400	33208				08/90 -	
	E5A-221	33213				-08/91	
	E5A-221	33209				-08/91	
	E5A-221	33213				09/91-03/93	
	E5A-221	33209				09/91-03/93	
	E5A-221	33213				04/93 -	
	E5A-221	33210				04/93 -	
	P 1140 D		32019X				
	P 1141 D		32019X				
	P 1340-A02		JF9549/10				
	P 1340-A02		33117				
	P 1341-A02		JF9549/10				
	P 1341-A02		33216				
	P 769-02		32019X			-02/91	
	P 769-02		32017X			-02/91	
	P 769-02		32019X			03/91 -	
	P 769-02		32017X			03/91 -	
	P 941-A01		32019X			-02/91	
	P 941-A01		32019X			03/91 -	
M 150/180							
	E 408-05	33211					
	E 408-05	33208					
	P 821/P 1021		594/593X				
	P 821/P 1021		594/593X				
M 150/180 [VF6-40 ACA/ACC]							
	E 400	33211					
	E 400	33208					
	E 401	33210					
	E 401	33207					
	E 402	33209					
	E 402	33207					
	E5A	33213				-03/93	
	E5A	33209				-03/93	
	E5A	33213				04/93 -	
	E5A	33210				04/93 -	
	1140		32019X				
	1140		33117				
	1141		32019X				
	1340		JF9549/10				
	1340		33117				
	1341		JF9549/10				
	1341		33216				
	669		33014			-05/95	
	669		33012			-05/95	
	669		32015X			06/95 -	



APPLICATION LISTINGS - TRUCK







							
RENAULT RVI							
M 150/180 [VF6-40 ACA/ACC] ...							
	669			32013X		06/95 -	
	769-02			32019X			
	769-02			32017X			
	769-05			33015			
	769-05			33013			
	769-06			32015X			
	769-06			32013X			
	940			32019X			
	940			32017X			
	941			32019X			
M 180 [VF6-40 ACB/ACD]							
	E 400	33211					
	E 400	33208					
	E 401	33210					
	E 401	33207					
	E 402	33209					
	E 402	33207					
	E5A	33213				-03/93	
	E5A	33209				-03/93	
	E5A	33213				04/93 -	
	E5A	33210				04/93 -	
	1140			32019X			
	1140			33117			
	1141			32019X			
	1340			JF9549/10			
	1340			33117			
	1341			JF9549/10			
	1341			33216			
	669			33014		-05/95	
	669			33012		-05/95	
	669			32015X		06/95 -	
	669			32013X		06/95 -	
	769-02			32019X			
	769-02			32017X			
	769-05			33015			
	769-05			33013			
	769-06			32015X			
	769-06			32013X			
	940			32019X			
	940			32017X			
	941			32019X			
M 180/210							
	E 408-05	33211					
	E 408-05	33208					
	P 821			594/593X			
	P 821			594/593X			
	P 1021			594/593X			
	P 1021			594/593X			





APPLICATION LISTINGS - TRUCK







     					
RENAULT RVI					
M 200/230					
E 400	33211				
E 400	33208				
E 400	33211				
E 400	33208				
E5A-221	33213				
E5A-221	33209				
E5A-221	33213				
E5A-221	33209				
E5A-221	33213				
E5A-221	33210				
P 1140 D		32019X			
P 1141 D		32019X			
P 1340-A02		JF9549/10			
P 1340-A02		33117			
P 1341-A02		JF9549/10			
P 1341-A02		33216			
P 769-02		32019X			
P 769-02		32017X			
P 769-02		32019X			
P 769-02		32017X			
P 941-A01		32019X			
P 941-A01		32019X			
M 210/230 TI [VF6-40]					
E 400	33211				
E 400	33208				
E 401	33210				
E 401	33207				
E 402	33209				
E 402	33207				
E5A	33213				
E5A	33209				
E5A	33213				
E5A	33210				
1140		32019X			
1140		33117			
1141		32019X			
1340		JF9549/10			
1340		33117			
1341		JF9549/10			
1341		33216			
669		33014			
669		33012			
669		32015X			
669		32013X			
769-02		32019X			
769-02		32017X			
769-05		33015			
769-05		33013			
769-06		32015X			
769-06		32013X			
940		32019X			
940		32017X			
941		32019X			



APPLICATION LISTINGS - TRUCK















							
RENAULT RVI							
M 250							
E5A		33213					-03/93
E5A		33209					-03/93
E5A		33213					04/93 -
E5A		33210					04/93 -
1140			32019X			ABS	
1140			32019X			ABS	
1140			33117			ABS	
1141			32019X				
1340			JF9549/10				
1340			33117				
1341			JF9549/10				
1341			33216				
669-03			33014				-05/95
669-03			33012				-05/95
669-03/05			32015X				06/95 -
669-03/05			32013X				06/95 -
769-02			32019X				
769-02			32017X				
769-05			33015				
769-05			33013				
769-06			32015X				
769-06			32013X				
940			32019X				
940			32017X				
941			32019X				
MAGNUM 390/430/470/560							
E 81		EK50042					-01/93
1341			JF9549/10				
1341			33216				
11 E/F			HM218248/10				
11 E/F			33213				
840 A			32019X				
840 A			33117				
1345			JF9549/10				
1370			JF9549/10				
1370			33117				
MAGNUM 400/440/480 E-TECH							
840 A			32019X				
840 A			33117				
1345			JF9549/10				
1370			JF9549/10				
1370			33117				
1341			JF9549/10				
1341			33216				
ME 160 [VF6-JE13] [4X2]							
E 400-04/14		33211					
E 400-04/14		33208					
E 408-AA		33214					
E 408-AA		33210					
E 408-05/13/15/24		33211					
E 408-05/13/15/24		33208					



APPLICATION LISTINGS - TRUCK







 		 			
RENAULT RVI					
ME 160 [VF6-JE13] [4X4]					
		32017X 32017X			
ME 160 [VF6-JE13] [4X2] [4X4]					
	P 821-13/17 P 821-13/17 P 1021-03 P 1021-03 P 1040-F, P 1140-F P 1040-F, P 1140-F P 1041-F, P 1141-F		594/593X 594/593X 594/593X 32217 32019X 33117 32019X		
ME 160/180 [VF6-JE 15] [4X2]					
	E 400-04/14 E 400-04/14 E 408-AA E 408-AA E 408-05/13/15/24 E 408-05/13/15/24 P 821-13/17 P 821-13/17 P 1021-03 P 1021-03 P 1040-F, P 1140-F P 1040-F, P 1140-F P 1041-F, P 1141-F	33211 33208 33214 33210 33211 33208	594/593X 594/593X 594/593X 32217 32019X 33117 32019X		
MIDLINER 120/140/160/200 [GB ONLY]					
	E 400 E 400 E 401-14 E 402-15 E5A22 769-01 769-02 769-05	33211 33208 33207 33209 33209	33015 32017X 33015		
MIDLUM [42B3/4-44T]					
	P 669 P 920 P 920		JLM714149P/110P 32017X JLM714149P/110P		
MIDLUM [FAB 42B1/2-43C1/2-43T/V]					
	P 920 P 920 P 669		32017X JLM714149P/110P JLM714149P/110P		
MIDLUM [FAB 42US-44US-45US]					
	P 920 P 920		32017X JLM714149P/110P		



APPLICATION LISTINGS - TRUCK



							
RENAULT RVI							
PA 160/180 MAROC							
	E 400	33211					-07/90
	E 400	33208					-07/90
	E 400	33211					08/90 -
	E 400	33208					08/90 -
	E5A-221	33213					-08/91
	E5A-221	33209					-08/91
	E5A-221	33213					09/91-03/93
	E5A-221	33209					09/91-03/93
	E5A-221	33213					04/93 -
	E5A-221	33210					04/93 -
	P 1140/1 D			32019X			
	P 1340/1-A02			JF9549/10			
	P 1340-A02			33117			
	P 1341-A02			33216			
	P 769-02			32019X			-02/91
	P 769-02			32017X			-02/91
	P 769-02			32019X			03/91 -
	P 769-02			32017X			03/91 -
	P 941-A01			32019X			-02/91
	P 941-A01			32019X			03/91 -
PC 27 S							
	E 401	33210					-09/90
	E 401	33207					-09/90
	769-05			33015			-09/90
	769-05			33013			-09/90
PP 160/180							
	E 400-06/16	33211					
	E 400-06/16	33208					
	E 401-03	33210					
	E 401-03	33207					
	769-01			33015			
	769-01			33013			
	P 769-02			32019X			
	P 769-02			32017X			
PREMIUM [6X2] [6X2/4]							
		EK50042					
		EK50042					
	1340			JF9549/10			
	1340			33216			
	1342			JF9549/10			
	1345			JF9549/10			
	16902-04			32019X			
	16902-04			33117			
	16902-05			32019X			
	16902-05			33117			
PREMIUM [6X2] PUSHER FAB 22A/22C							
	P 1342			JT9049/10			
	P 1345			JT9049/10			



APPLICATION LISTINGS - TRUCK

A













RENAULT RVI							
PREMIUM PT/TR							
	1340 1340 1342 1345 16902-04 16902-04 16902-05 16902-05	EK50042 EK50042		JF9549/10 33216 JF9549/10 JF9549/10 32019X 33117 32019X 33117			
PREMIUM PT/TR [4X2]							
	P 1345		JT9049/10				
PS 130-09/150-09							
	401 401 769 769 SOMA 95 HD SOMA 95 HD	33210 33207		33015 33013 33015 33013		03/85 - 03/85 -	
PS 150/160							
	E 400-06/16 E 400-06/16 401-03 401-03 R 769-01 R 769-01 R 769-02 R 769-02	33211 33208 33210 33207		33015 33013 32019X 32017X			
PS 150 CARRIER							
	401 401 769 769	33210 33207		33015 33013		-09/90 -09/90 -09/90 -09/90	
PX 28/28 T, PX 30/30 T							
	E6A E6A P 1332/ P 1332 B P 1332/ P 1332 B	33214 33209		JHM720249/10 64432/64708			
PX 30 V/VT							
	E6A-21 E6A-21 PMA 1021/PMA 1321 PMA 1021/PMA 1321 PMA 1032 B/PMA 1532 PMA 1032 B/PMA 1532	33214 33209		683/672 52375/52618 JHM720249/10 64432/64708			





APPLICATION LISTINGS - TRUCK

















 		 			
RENAULT RVI					
R 350 ...					
	E84-AG/EG/GG E84-AG/EG/GG E 85-CM/E 85-JH E 85-CM/E 85-JH P 1332, PMA/P 1532 P 1332, PMA/P 1532 P 1345 PMA/PR 1341 PMA/PR 1341	EK50042 EK50042 EK50042 EK50042		JHM720249/10 64432/64708 JF9549/10 JF9549/10 33216	09/93- 09/93- 09/93- 09/93-
R 360/360 T [6X4]					
	E6A E6A E6A P 1332 B/B1, P 1332, E 42 P 1332 B/B1, P 1332, E 42	33214 33209 33214		JHM720249/10 64432/64708	-14/03/84 -14/03/84 15/03/84-
R 370					
	E6A P 1332 P 1332 P 1345	33214		JHM720249/10 64432/64708 JF9549/10	
R 380					
	E6A-32 E6A-32/E6A-33 E6 A-32/33 /1/211/311 E6B-211/311 E84-AG/EG/GG E 85-CM E84-AG/EG/GG E84-AG/EG/GG E 85-CM E 85-CM E 85-CM E 85-JH E 85-JH P 1332, PMA/P 1532 P 1332, PMA/P 1532 P 1345 PMA/PR 1341 PMA/PR 1341	33214 33214 33214 33214 33214 33214 EK50042 EK50042 EK50042 EK50042 EK50042 EK50042 EK50042		JHM720249/10 64432/64708 JF9549/10 JF9549/10 33216	- 08/91  - 08/91  09/91- 09/91- 09/91- 09/91- 09/93- 09/93- 09/93- 09/93-
R 385 TI					
	E6A-32 E6A-32/E6A-33 E6 A-32/33 /1/211/311 E6B-211/311 E84-AG/EG/GG E 85-CM E84-AG/EG/GG E84-AG/EG/GG E 85-CM E 85-CM E 85-CM E 85-JH	33214 33214 33214 33214 33214 33214 EK50042 EK50042 EK50042 EK50042 EK50042			- 08/91  - 08/91  09/91- 09/91- 09/91- 09/91- 09/93- 09/93- 09/93- 09/93-



APPLICATION LISTINGS - TRUCK



					
RENAULT RVI					
R 385 TI ...					
	E 85-JH P 1332, PMA/P 1532 P 1332, PMA/P 1532 P 1345 PMA/PR 1341 PMA/PR 1341	EK50042	JHM720249/10 64432/64708 JF9549/10 JF9549/10 33216		
R 390					
	E6A P 1332 P 1332 P 1345	33214	JHM720249/10 64432/64708 JF9549/10		
R 390/420 [6X4]					
	E6A P MA/PR 1532 P MA/PR 1532 P MA/PR 1341	33214	JHM720249/10 64432/64708 JF9549/10		
R 390 T / R 420					
	E6A P 1332 P 1332 P 1345	33214	JHM720249/10 64432/64708 JF9549/10		
R 420 T					
	P 1332 P 1332 P 1345		JHM720249/10 64432/64708 JF9549/10		
R 420 TI / R [6X4] TS					
	E6A-32 E6A-32/E6A-33 E6 A-32/33 /1/211/311 E84-AG/EG/GG E6B-211/311 E 85-CM E84-AG/EG/GG E84-AG/EG/GG E 85-CM E 85-CM E 85-JH E 85-JH P 1332, PMA/P 1532 P 1332, PMA/P 1532 P 1345 PMA/PR 1341 PMA/PR 1341	33214 33214 33214 33214 33214 33214 EK50042 EK50042 EK50042 EK50042 EK50042 EK50042 EK50042	JHM720249/10 64432/64708 JF9549/10 JF9549/10 33216		- 08/91  - 08/91  09/91- 09/91- 09/91- 09/91- 09/93- 09/93- 09/93- 09/93- 09/93- 09/93-
R I 357					
	E6A-32 P 1332, PMA/P 1532 P 1332, PMA/P 1532 P 1345	33214	JHM720249/10 64432/64708 JF9549/10		



APPLICATION LISTINGS - TRUCK

A



RENAULT RVI					
R I 357 ...					
	PMA/PR 1341 PMA/PR 1341		JF9549/10 33216		
S 90-09 [VF6-JN]					
	401	33209			-02/85
	401	32305			-02/85
	401	33210			03/85 -
	401	33207			03/85 -
	SOMA 95		33015		
	SOMA 95		33013		
	769-01		33015		
	769-01		33013		
S 100 [VF6-JK]					
	401	33210			
	401	33207			
	402	33209			
	402	33206			
	SOMA 95		33015		-1986
	SOMA 95		33013		-1986
	669		33014		
	669		33012		
	769		33015		1987-
	769		33013		1987-
S 110/130 [VF6-JK]					
	402	33209			
	402	33206			
	669		33014		
	669		33012		
S 120/135 [VF6]					
	401	33210			-02/92
	401	33207			-02/92
	401	33210			03/92-
	401	33207			03/92-
	402	33209			-02/92
	402	33206			-02/92
	402	33209			03/92-
	402	33207			03/92-
	669		33014		-05/95
	669		33012		-05/95
	669		32015X		06/95-
	669		32013X		06/95-
	769		33015		
	769		33013		
S 130-06/08/09 [VF6-JN]					
	401	33209			-02/85
	401	32305			-02/85
	401	33210			03/85-
	401	33207			03/85-
	SOMA 95		33015		
	SOMA 95		33013		





APPLICATION LISTINGS - TRUCK











RENAULT RVI					
S 130-06/08/09 [VF6-JN] ...					
	769-01 769-01		33015 33013		
S 130/150/170 [VF6-JP]					
	400 400 P 620/P 820 P 620/P 820 P 821 P 821	33211 33208	33018 33015 594/593X 594/593X		
S 135/150 [VF6-AE]					
	401 401 402 402 669 669 769 769	33210 33207 33209 33207	32015X 32013X 33015 33013		
S 140/160 [VF-6]					
	401 401 401 401 402 402 402 402 669 669 769 769	33210 33207 33210 33207 33209 33206 33209 33207	33014 33012 33015 33013		
S 150-06/08/09 [VF6-JN]					
	401 401 401 401 SOMA 95 SOMA 95 769-01 769-01	33209 32305 33210 33207	33015 33013 33015 33013		-02/85 -02/85 03/85- 03/85-
S 150 [VF6-JK-SC, VF6-JN-1E]					
	E 400 E 400 E 401 E 401 E 402 E 402 E5A E5A	33211 33208 33210 33207 33209 33207 33213 33209			-03/93 -03/93



APPLICATION LISTINGS - TRUCK













A



 		 			
RENAULT RVI					
S 150 [VF6-JK-SC, VF6-JN-1E] ...					
	E5A	33213			04/93-
	E5A	33210			04/93-
	669		33014		-05/95
	669		33012		-05/95
	669		32015X		06/95-
	669		32013X		06/95-
	769-02		32019X		
	769-02		32017X		
	769-05		33015		
	769-05		33013		
	769-06		32015X		
	769-06		32013X		
	940		32019X		
	940		32017X		
	941		32019X		
	1140		32019X		
	1140		33117		
	1141		32019X		
	1340		JF9549/10		
	1340		33117		
	1341		JF9549/10		
	1341		33216		
S 150/180 [VF6 40-ACF/ACE]					
	E 400	33211			
	E 400	33208			
	E 401	33210			
	E 401	33207			
	E 402	33209			
	E 402	33207			
	E5A	33213			-03/93
	E5A	33209			-03/93
	E5A	33213			04/93-
	E5A	33210			04/93-
	669		33014		-05/95
	669		33012		-05/95
	669		32015X		06/95-
	669		32013X		06/95-
	769-02		32019X		
	769-02		32017X		
	769-05		33015		
	769-05		33013		
	769-06		32015X		
	769-06		32013X		
	940		32019X		
	940		32017X		
	941		32019X		
	1140		32019X		
	1140		33117		
	1141		32019X		
	1340		JF9549/10		
	1340		33117		
	1341		JF9549/10		
	1341		33216		

APPLICATION LISTINGS - TRUCK



					
RENAULT RVI					
S 170 [4X4]					
	E 408-05	33211			
	E 408-05	33208			
	SINPAR MD 3000	33015			6 M75, - 05/91
	SINPAR MD 3000	32015X			6 M75, - 05/91
	SINPAR MD 3000	33014			6 M70, - 05/91
	SINPAR MD 3000	32014X			6 M70, - 05/91
	SINPAR MD 4000	32018X			-05/91
	SINPAR MD 4000	32018X			-05/91
	3 MRDIF-155/156/158/171	32017X			-05/91
	3 MRDIF-155/156/158/171	32015X			-05/91
	3 MRDIF-214/216/219	32017X			-05/91
	3 MRDIF-214/216/219	32015X			-05/91
	3 MRDIF-8274	32017X			-05/91
	3 MRDIF-8274	32017X			-05/91
	3 MRDIF-8500 FW	32017X			-05/91
	3 MRDIF-8500 FW	32017X			-05/91
	P 1021 K		594/593X		-05/91
	P 1021 K		32217		-05/91
	P 821/P 1021		594/593X		
	P 821/P 1021		594/593X		
S 170/220 [VF6-JS]					
	408-05	33211			
	408-05	33208			
	P 1020		594/593X		07/86-
	P 1020		665X/653X		07/86-
	P 1021		594/593X		
	P 1021		594/593X		
S 210					
	E5A	33213			-03/93
	E5A	33209			-03/93
	E5A	33213			04/93-
	E5A	33210			04/93-
	669-03		33014		-05/95
	669-03		33012		-05/95
	669-03/05		32015X		
	669-03/05		32013X		
	769-02		32019X		
	769-02		32017X		
	769-05		33015		
	769-05		33013		
	769-06		32015X		
	769-06		32013X		
	940		32019X		
	940		32017X		
	941		32019X		
	1140		32019X		
	1140		32019X		
	1140		33117		
	1141		32019X		
	1340		JF9549/10		
	1340		33117		
	1341		JF9549/10		
	1341		33216		



APPLICATION LISTINGS - TRUCK

A

































RENAULT RVI							
TBH 280 [6X6]							
	PA 721 PA 721 PMA/P 1532 PMA/P 1532	594/593X 32217		JHM720249/10 64432/64708			
TBH 280 [6X4]/[6X4D]							
	E6A E6A E6A-511 PMA/PR 1032 PMA/PR 1032	33214 33209 33214		JHM720249/10 64432/64708		15/03/84-	
TBH 280 [6X6]							
	E6A E6A PKBS 3 PKBS 3 PMA/PR 1032 PMA/PR 1032 PMA/PR 1032 PMA/PR 1032	33214 33209 32018X 32017X		JHM720249/10 64432/64708 JHM720249/10 64432/64708			
TLM 280							
	E6A-51 E6A-51 E6A-51 P 1532 P 1532	33214 33209 33214		JHM720249/10 64432/64708		-14/03/84 -14/03/84 15/03/84-	
TR 280/350							
	E6A E6A P 1332 P 1332	33214 33209		JHM720249/10 64432/64708			
TR 305							
	E6A E6A P 1332/B P 1332/B	33214 33209		JHM720249/10 64432/64708			
TR 305 [6X4]							
	E6A-21 E6A-21 PMA 102/PMA 1321 PMA 102/PMA 1321 PMA 1032 B/PMA 1532 PMA 1032 B/PMA 1532	33214 33209		683/672 52375/52618 JHM720249/10 64432/64708			
TRH 350 [6X4], TRH 350 TS							
	E6A-21 E6A-21 PMA/PR 1021, PMA/PR 1321 PMA/PR 1021, PMA/PR 1321	33214 33209		683/672 52375/52618			



APPLICATION LISTINGS - TRUCK



					
RENAULT RVI					
TRH 350 [6X4], TRH 350 TS ...					
	PMA/PR 1032 B, PMA/P 1532 PMA/PR 1032 B, PMA/P 1532		JHM720249/10 64432/64708		
TRM 2000					
	SOMA 3 MRDIPF 8250 SOMA 3 MRDIPF 8250 SOMA 3 MRDISP 8500 SOMA 3 MRDISP 8500 SOMA 3 MRPF 8250 SOMA 3 MRPF 8250 SOMA 3 MRSP 8500 SOMA 3 MRSP 8500	JM511946/10 32014X JM511946/10 32014X	JM511946/10 32014X JM511946/10 32014X		- 03/89 - 03/89 04/89 - 04/89 - - 03/89 - 03/89 04/89 - 04/89 -
TRM 4000					
	HWT 1093 HWT 1093 SOMA 12	580/572 567/563	32015X		
SAURER					
D 180, D 230, D 230 FK, D 290 F/N, D 330 F					
	6.5-8 T 6.5-8 T 6.5-8 T 6.5-8 T	JH211749/10 JM205149/10	JM822049/10 JHM522649/10		
D 330 F [6X2]/[8X4], D 330 N [4X2]/[6X4]					
	6.5-8 T 6.5-8 T 6.5-8 T 6.5-8 T	JH211749/10 JM205149/10	JM822049/10 JHM522649/10		
SCANIA					
94 C / D / G / L					
	AM 620 AM 620/AM 920 AM 620/AM 920/AMA 860 AM 820 D AM 900 AM 740/AMA 740/AMA 860 AM 920 AD 1100 AD 1100 AD 1100 P AD 1100 P ADA 1100 ADA 1100 AD 1300/ADA 1300	NP078914-90UA1 NP078914-90UA1 NP078914-90UA1 NP078914-90UA1 NP078914-90UA1 NP078914-90UA1 NP078914-90UA1	HM218248Z/10 HM218248Z/10 HM218248Z/10 HM218248Z/10 HM218248Z/10 HM218248Z/10 HM218248Z/10	      	 -Ch.9015825SAN  Ch.9015825SAN, 4362207SNL, 1226892SSS-     Ch.9015825SAN, 4362207SNL, 1226892SSS -  Ch.9015825SAN/ 4362207SNL/1226892SSS-  15  15  20/22.5" RP/RBP730  20/22.5" RP/RBP730  20/22.5/24" 15  20/22.5/24" 15  20/22.5/24" 15

APPLICATION LISTINGS - TRUCK



SCANIA					
94 C / D / G / L ...					
	AD 1300/ADA 1300 AS 900 AS 900 ASA 1000 ASA 1000 ASA 1000 D ASA 1000 D AS 1300 AS 1300		HM218248Z/10 HM218248Z/10 HM218248Z/10 HM218248Z/10 HM218248Z/10 HM218248Z/10 HM218248Z/10 HM218248Z/10 HM218248Z/10		
114 C / G / L					
	AM 620 AM 620/AM 920 AM 620/AM 920/AMA 860 AM 740/AMA 740 AM 820 D AM 900 AM 920 ADA ADA ADA 1000 ADA 1000 ADA 1100 ADA 1100 AD 1100 P AD 1100 P AD 1300/ADA 1300 AD 1300/ADA 1300 AS 900 AS 900 AS 900 AS 900 ASA 1000 ASA 1000 ASA 1000 D ASA 1000 D AS 1300 AS 1300	NP078914-90UA1 NP078914-90UA1 NP078914-90UA1 NP078914-90UA1 NP078914-90UA1 NP078914-90UA1 NP078914-90UA1	HM218248Z/10 HM218248Z/10		
124 C / G / L					
	AM 620 AM 740 AM 740 D AMA 740 AMA 740 D AM 820 D AMA 860 AMA 860 D AM 900 AM 920 AMD 900	NP078914-90UA1 NP078914-90UA1 NP078914-90UA1 NP078914-90UA1 NP078914-90UA1 NP078914-90UA1 NP078914-90UA1 NP078914-90UA1 NP078914-90UA1 NP078914-90UA1 XC8640/HM220110			













































































APPLICATION LISTINGS - TRUCK



SCANIA						
124 C / G / L ...						
	AMD 900 ADA 1100 ADA 1100 ADA 1100 ADA 1100 AD 1100 P AD 1100 P AD 1300 AD 1300 AD 1300 AD 1300 ADA 1300 ADA 1300 ADA 1300 ADA 1300 AD 1300 D AD 1300 D AS 900 AS 900 AS 900 AS 900 ASA 1000 ASA 1000 ASA 1000 D ASA 1000 D AS 1300 AS 1300 ASA 80 ASA 80	XC8640/HM220110	HM218248Z/10 32216 33215			
144C / 144G / 144L						
	AM 620 AM 740/AM 740D AMA 740/AMA 740D AM 820 D AMA 860/D AM 900 AM 920 ADA 1100 ADA 1100 ADA 1100 ADA 1100 ADA 1100 AD 1100 P AD 1100 P AD 1100 P AD 1100 P ADA 1300 D ADA 1300 D AD 1300/ADA 1300 AD 1300/ADA 1300 AD 1300/ADA 1300 AD 1300/ADA 1300	NP078914-90UA1 NP078914-90UA1 NP078914-90UA1 NP078914-90UA1 NP078914-90UA1 NP078914-90UA1 NP078914-90UA1 NP078914-90UA1	HM218248Z/10 HM218248Z/10			

















































































APPLICATION LISTINGS - TRUCK



 		 			
SCANIA					
144C / 144G / 144L ...					
	AS 900 AS 900 ASA 1000 ASA 1000 ASA 1000 ASA 1000 AS 1300 AS 1300 ASA 70 ASA 80 ASA 80		HM218248Z/10 HM218248Z/10 HM218248Z/10 HM218248Z/10 HM218248Z/10 HM218248Z/10 HM218248Z/10 HM218248Z/10 HM218248Z/10 JF7049A/10 32216 33215	         	 15  15  15  15  15  15  15  15  15  15
G/P 82					
	AM 55 AM 55 AM 55 AM 55 AM 55 AM 55 AM 55 AM 55 AM 55 AM 60 AM 60 AD 80 AD 80 AD 80 AD 80 AD 90/ADA 90 AD 90/ADA 90 AD 90/ADA 90 AD 90/ADA 90 AD 90/ADA 90 AD 90/ADA 90 4248317SN AD 90/ADA 90 AD 90/ADA 90 AD 90/ADA 90 AD 90/ADA 90 TRAILING AXLE/ASA 60 TRAILING AXLE/ASA 60 TRAILING AXLE/ASA 70	32311 32308 32311 32308 32311 32308 32311 32308 32312 32309	32216 33215 32216 32215 HM218248Z/10 HM218248Z/10 HM218248Z/10 HM218248Z/10 32218 32218 HM218248Z/10 HM218248Z/10 32218 32218 32312 32309 JF7049A/10	                      	-Ch.1097602SSS, 4246024SN -Ch.1097602SSS, 4246024SN Ch.1097603SSS/4238514SN - Ch.1097603SSS/4238514SN - -Ch.1105665SSS, 4238514SN -Ch.1105665SSS, 4238514SN Ch.1105666SSS/4238515SN - Ch.1105666SSS/4238515SN -  15  15  15  15  15  15  15  15  15  15  15  15  15  15  15
G/P 82 H [6X2]					
	TRAILING AXLE TRAILING AXLE TRAILING AXLE TRAILING AXLE TRAILING AXLE TRAILING AXLE		HM218248Z/10 HM218248Z/10 HM218248Z/10 HM218248Z/10 32218 32218	     	 15  15  15  15  15  15







APPLICATION LISTINGS - TRUCK



						 					
SCANIA											
G/P 82 M [6X2]											
	TRAILING AXLE			32312							
	TRAILING AXLE			32309							
G 92, P 92 /M/H											
	AM 55	32311									-Ch.1097602SSS, 4246024SN
	AM 55	32308									-Ch.1097602SSS, 4246024SN
	AM 55	32311									Ch.1097603SSS/4238514SN -
	AM 55	32308									Ch.1097603SSS/4238514SN -
	AM 55	32311									-Ch.1105665SSS, 4238514SN
	AM 55	32308									-Ch.1105665SSS, 4238514SN
	AM 55	32311									Ch.1105666SSS, 4238515SN-101 -
	AM 55	32308									Ch.1105666SSS, 4238515SN-101 -
	AM 60	32312									
	AM 60	32309									
	AD 80			32216							
	AD 80			32215							
	AD 80			32216							
	AD 80			32215							
	AD 90			HM218248Z/10							2300mm wide ch. 15
	AD 90			HM218248Z/10							2300mm wide ch. 15
	AD 90			32218							24" 
	AD 90			32218							24" 
	AD 90			HM218248Z/10							20/22"  Ch.1033188SSS/ 4248318SN - 15
	AD 90			HM218248Z/10							20/22"  Ch.1033188SSS/ 4248318SN - 15
	AD 90/ADA 90			32218							20/22"  -Ch.1103187SSS, 428317SN
	AD 90/ADA 90			32218							20/22"  -Ch.1103187SSS, 428317SN
	AD 90/ADA 90			HM218248Z/10							15
	AD 90/ADA 90			HM218248Z/10							15
	TRAILING AXLE/ASA 60			32312							
	TRAILING AXLE/ASA 60			32309							
	TRAILING AXLE/ASA 70			JF7049A/10							
G/P/R 92 H [6X2]											
	TRAILING AXLE/AS 90			32218							
	TRAILING AXLE/AS 90			32218							
G/P 92 M [6X2]											
	TRAILING AXLE			32312							
	TRAILING AXLE			32309							
G/P 92 [6X2] [6X4]											
	TRAILING AXLE/ASA 60			32312							
	TRAILING AXLE/ASA 60			32309							
	TRAILING AXLE/ASA 70			JF7049A/10							
	TRAILING AXLE/ARA 55			32311							
	TRAILING AXLE/ARA 55			32308							



















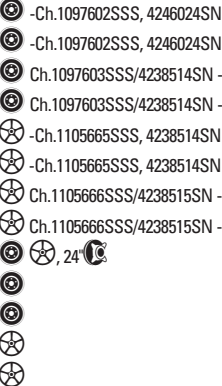









APPLICATION LISTINGS - TRUCK



 		 			
SCANIA					
G/P/R/T 93, P 93 M/H					
AM 56	JF6049/10				
AM 56	32309				
AM 56	32312				
AM 56	32309				
AM 61	32312				
AM 61	32309				
AM 70	JF7049A/10				
AM 70	JF7049A/10				
AM 70	JF7049A/10				
AD 80		32216			
AD 80		33215			
AD 80		32216			
AD 80		32215			
AD 90/ADA 90		HM218248Z/10			
AD 90/ADA 90		HM218248Z/10			
AD 90/ADA 90		HM218248Z/10			
AD 90/ADA 90		HM218248Z/10			
AD 90/ADA 90		32218			
AD 90/ADA 90		32218			
AD 90/ADA 90		32218			
AD 90/ADA 90		32218			
AD 100		HM220149Z/10			
AD 100		HM220149Z/10			
AD 100		HM220149Z/10			
AD 100		HM220149Z/10			
ARA 56	JF6049/10				
ARA 56	32309				
TRAILING AXLE/AS 90	HM218248Z/10				
TRAILING AXLE/AS 90	HM218248Z/10				
TRAILING AXLE	32218				
TRAILING AXLE	32218				
TRAILING AXLE/ASA 60	32312				
TRAILING AXLE/ASA 60	32309				
TRAILING AXLE/ASA 70	JF7049A/10				
TRAILING AXLE/ASA 80	32216				
TRAILING AXLE/ASA 80	33215				
G/P/R 112					
AM 60	32312				
AM 60	32309				
AD 90/ADA 90		HM218248Z/10			
AD 90/ADA 90		HM218248Z/10			
AD 90/ADA 90		32218			
AD 90/ADA 90		32218			
AD 90/ADA 90		HM218248Z/10			
AD 90/ADA 90		HM218248Z/10			
AD 90/ADA 90		HM218248Z/10			
AD 90/ADA 90		HM218248Z/10			
AD 90/ADA 90		32218			
AD 90/ADA 90		32218			

APPLICATION LISTINGS - TRUCK





























					
SCANIA					
G/P/R 112 ...					
	AD 100 AD 100 ARA 55 ARA 55 TRAILING AXLE/ASA 60 TRAILING AXLE/ASA 60 TRAILING AXLE/ASA 70		HM220149Z/10 HM220149Z/10 32311 32308 32312 32309 JF7049A/10		
G/P/R 112 M					
	AM 55 AM 55 AM 55 AM 55 AM 55 AM 55 AM 55 AM 55 AM 70 AD 80 AD 80 AD 80 AD 80	32311 32308 32311 32308 32311 32308 32311 32308 JF7049A/10	32216 33215 32216 32215		 -Ch.1097602SSS, 4246024SN -Ch.1097602SSS, 4246024SN Ch.1097603SSS/4238514SN - Ch.1097603SSS/4238514SN - -Ch.1105665SSS, 4238514SN -Ch.1105665SSS, 4238514SN Ch.1105666SSS/4238515SN - Ch.1105666SSS/4238515SN - Ch.1105666SSS/4238515SN -  24" 
L/LB 80					
		32308			Ch.1032242 -
L/LB 81					
	AM 55 AM 55 AM 60 AM 60 R 640 R 640 R 640 R 640 R 640 R 640	32311 32308 32312 32309	32216 32215 32216 33215 32216 32215		Ch.1032242 - Ch.1032242 -  -Ch.1032241  -Ch.1032241  Ch.1032242 -  Ch.1032242 -  
L 85					
	R 650/RD 650/R651/R751 R 650/RD 650/R651/R751	32308	32218 32218		
L 86					
	AM 55 AM 55 AM 60 AM 60 R 651/R 653/R 751/R 752 R 651/R 653/R 751/R 752 R 651/R 653/R 751/R 752 R 651/R 653/R 751/R 752 R 651/R 653/R 751/R 752 R 651/R 653/R 751/R 752	32311 32308 32312 32309	HM218248Z/10 HM218248Z/10 32218 32218 32218 32218		 -Ch.1032241 -Ch.1032241  Ch.1033748-15  Ch.1033748-15  -Ch.1033747  -Ch.1033747  

APPLICATION LISTINGS - TRUCK











A



     					
SCANIA					
L 110					
	R 650/RD 650/R 651/R 751 R 650/RD 650/R 651/R 751 RP 750 RP 750	32308	32218 32218 32219 32219		
L 111					
	AM 55 AM 55 AM 60 AM 60 AD 90 AD 90 AD 90 AD 90 AD 90 AD 90 AD 90 AD 90 AD 90 AD 95 AD 95 AD 100 AD 100	32311 32308 32312 32309	HM218248Z/10 HM218248Z/10 32218 32218 HM218248Z/10 HM218248Z/10 32218 32218 32219 32219 HM220149Z/10 HM220149Z/10		Ch.1032242 - Ch.1032242 -  Ch.1033748-15  Ch.1033748-15  -Ch.1033747  -Ch.1033747  2300mm wide ch. 15  2300mm wide ch. 15   
L/LS 140, LT 145					
	RP 751 RP 751 R 651/RPB 652/RP 750 R 651/RPB 652/RP 750 TRAILING AXLE TRAILING AXLE	32312 32309	32218 32218 32219 32219 32218 32218		
L 141					
	AD 90 AD 90 AD 90 AD 90 AD 90 AD 90 AD 95 AD 95 AD 100 AD 100	32312 32309	32218 32218 HM218248Z/10 HM218248Z/10 32218 32218 32219 32219 HM220149Z/10 HM220149Z/10		 -Ch.1033747  -Ch.1033747  Ch.1033748-15  Ch.1033748-15  
LB 85					
	R 650/RD 650/R651/R751 R 650/RD 650/R651/R751	32312 32309	32218 32218		

APPLICATION LISTINGS - TRUCK

















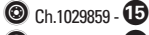
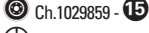



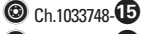
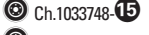



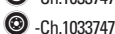

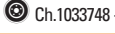

					
SCANIA					
LB 86					
	AM 60 AM 60 R 651/R 653/R 751/R 752 R 651/R 653/R 751/R 752 R 651/R 653/R 751/R 752 R 651/R 653/R 751/R 752 R 651/R 653/R 751/R 752 R 651/R 653/R 751/R 752	32312 32309	HM218248Z/10 HM218248Z/10 32218 32218 32218 32218		⊗ Ch.1033748-15 ⊗ Ch.1033748-15 ⊗ -Ch.1033747 ⊗ -Ch.1033747 ⊗ ⊗
LB 110					
	R 650/RD 650/R 651/R 751 R 650/RD 650/R 651/R 751 RP 750 RP 750	32312 32309	32218 32218 32219 32219		
LB 111					
	AM 60 AM 60 AD 90 AD 90 AD 90 AD 90 AD 90 AD 90 AD 90 AD 95 AD 95 AD 95 AD 95 AD 100 AD 100 TRAILING AXLE TRAILING AXLE TRAILING AXLE TRAILING AXLE TRAILING AXLE TRAILING AXLE	32312 32309	32218 32218 HM218248Z/10 HM218248Z/10 32218 32218 HM218248Z/10 HM218248Z/10 32219 32219 32219 32219 HM220149Z/10 HM220149Z/10 32218 32218 HM218248Z/10 HM218248Z/10 32218 32218		⊗ -Ch.1029858 ⊗ -Ch.1029858 ⊗ Ch.1029859 - 15 ⊗ Ch.1029859 - 15 ⊗ ⊗ 2300mm wide ch. 15 ⊗ 2300mm wide ch. 15 ⊗ -Ch.1029858 ⊗ -Ch.1029858 4 4 ⊗ -Ch.1029858 ⊗ -Ch.1029858 ⊗ Ch.1029859 - 15 ⊗ Ch.1029859 - 15 ⊗ ⊗
LB 140					
	R 651/R 652/RB 652 R 651/R 652/RB 652 RBP 652/R 752 RBP 652/R 752 R 750 R 750	32312 32309	32218 32218 32218 32218 32219 32219		

APPLICATION LISTINGS - TRUCK



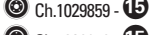
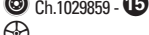







A



 		 			
SCANIA					
LB 141					
	AD 90 AD 90 AD 90 AD 90 AD 95 AD 95 AD 100 AD 100	32312 32309	HM218248Z/10 HM218248Z/10 32218 32218 32219 32219 HM220149Z/10 HM220149Z/10		 Ch.1029859 - 15  Ch.1029859 - 15  
LBS 85					
	R 650/RD 650/R651/R751 R 650/RD 650/R651/R751 TRAILING AXLE TRAILING AXLE	32312 32309	32218 32218 32218 32218		
LBS 86					
	AM 60 AM 60 R 651/R 653/R 751/R 752 R 651/R 653/R 751/R 752 R 651/R 653/R 751/R 752 R 651/R 653/R 751/R 752 R 651/R 653/R 751/R 752 R 651/R 653/R 751/R 752 TRAILING AXLE TRAILING AXLE TRAILING AXLE TRAILING AXLE TRAILING AXLE TRAILING AXLE	32312 32309	HM218248Z/10 HM218248Z/10 32218 32218 32218 32218 32218 32218 32218 32218 32218 HM218248Z/10 HM218248Z/10		 Ch.1033748 - 15  Ch.1033748 - 15  -Ch.1033747  -Ch.1033747    -Ch.1033747  -Ch.1033747    Ch.1033748 -  Ch.1033748 -
LBS 110					
	R 650/RD 650/R 651/R 751 R 650/RD 650/R 651/R 751 RP 750 RP 750 TRAILING AXLE TRAILING AXLE	32312 32309	32218 32218 32219 32219 32218 32218		
LBS 111					
	AM 60 AM 60 AD 90 AD 90 AD 90 AD 90 AD 90 AD 90	32312 32309	32218 32218 HM218248Z/10 HM218248Z/10 32218 32218		 -Ch.1029858  -Ch.1029858  Ch.1029859 - 15  Ch.1029859 - 15  



















































































APPLICATION LISTINGS - TRUCK



					
SCANIA					
LBS 111 ...					
	AD 95 AD 95 AD 95 AD 95 AD 100 AD 100 TRAILING AXLE TRAILING AXLE TRAILING AXLE TRAILING AXLE TRAILING AXLE TRAILING AXLE		32219 32219 32219 32219 HM220149Z/10 HM220149Z/10 32218 32218 HM218248Z/10 HM218248Z/10 32218 32218		⊗ -Ch.1029858 ⊗ -Ch.1029858 ④ ④ ⊗ -Ch.1029858 ⊗ -Ch.1029858 ⊗ Ch.1029859 - 15 ⊗ Ch.1029859 - 15 ⊗ ⊗
LBS 140					
	R 651/R 652/RB 652 R 651/R 652/RB 652 RBP 652/R 752 RBP 652/R 752 R 750 R 750 TRAILING AXLE TRAILING AXLE	32312 32309	32218 32218 32218 32218 32219 32219 32218 32218		
LBS 141					
	AD 90 AD 90 AD 90 AD 90 AD 95 AD 95 AD 100 AD 100 TRAILING AXLE TRAILING AXLE TRAILING AXLE TRAILING AXLE TRAILING AXLE TRAILING AXLE	32312 32309	HM218248Z/10 HM218248Z/10 32218 32218 32219 32219 HM220149Z/10 HM220149Z/10 32218 32218 HM218248Z/10 HM218248Z/10 32218 32218		⊗ Ch.1029859 - 15 ⊗ Ch.1029859 - 15 ⊗ ⊗ ⊗ -Ch.1029858 ⊗ -Ch.1029858 ⊗ Ch.1029859 - 15 ⊗ Ch.1029859 - 15 ⊗ ⊗
LBT 111					
	AM 60 AM 60	32312 32309			
LBT 111 BB					
	AD 90 AD 90 AD 90 AD 90 AD 90 AD 90		32218 32218 HM218248Z/10 HM218248Z/10 32218 32218		⊗ -Ch.1029858 ⊗ -Ch.1029858 ⊗ Ch.1029859 - 15 ⊗ Ch.1029859 - 15 ⊗ ⊗











APPLICATION LISTINGS - TRUCK



				 			
SCANIA							
LBT 111 BB ...							
	AD 90			HM218248Z/10			 2300mm wide ch. 15
	AD 90			HM218248Z/10			 2300mm wide ch. 15
LBT 111 FB							
	AD 80			32216			 -Ch.1029858
	AD 80			32215			 -Ch.1029858
	AD 80			32216			 Ch.1029859 -
	AD 80			33215			 Ch.1029859 -
	AD 80			32216			
	AD 80			32215			
	AD 90			32218			 -Ch.1029858
	AD 90			32218			 -Ch.1029858
	AD 90			HM218248Z/10			 Ch.1029859 - 15
	AD 90			HM218248Z/10			 Ch.1029859 - 15
	AD 90			32218			
	AD 90			32218			
LBT 140							
			32312				
			32309				
	R 651/R 652/RB 652			32218			
	R 651/R 652/RB 652			32218			
	RBP 652/R 752			32218			
	RBP 652/R 752			32218			
LBT 141							
			32312				
			32309				
LBT 141 BB							
	AD 90			HM218248Z/10			 Ch.1029859 - 15
	AD 90			HM218248Z/10			 Ch.1029859 - 15
	AD 90			32218			
	AD 90			32218			
	AD 95			32219			 4
	AD 95			32219			 4
	AD 95			32219			
	AD 95			32219			
	AD 100			HM220149Z/10			
	AD 100			HM220149Z/10			
LBT 141 FB							
	AD 80			32216			 -Ch.1029858
	AD 80			32215			 -Ch.1029858
	AD 80			32216			 Ch.1029859 -
	AD 80			33215			 Ch.1029859 -
	AD 80			32216			
	AD 80			32215			
	AD 90			32218			 -Ch.1029858
	AD 90			32218			 -Ch.1029858
	AD 90			HM218248Z/10			 Ch.1029859 - 15
	AD 90			HM218248Z/10			 Ch.1029859 - 15
	AD 90			32218			
	AD 90			32218			

APPLICATION LISTINGS - TRUCK



					
SCANIA					
LS 85					
	R 650/RD 650/R651/R751 R 650/RD 650/R651/R751 TRAILING AXLE TRAILING AXLE	32308	32218 32218 32218 32218		
LS 86					
	AM 55 AM 55 AM 60 AM 60 R 651/R 653/R 751/R 752 R 651/R 653/R 751/R 752 R 651/R 653/R 751/R 752 R 651/R 653/R 751/R 752 R 651/R 653/R 751/R 752 R 651/R 653/R 751/R 752 TRAILING AXLE TRAILING AXLE TRAILING AXLE TRAILING AXLE TRAILING AXLE TRAILING AXLE	32311 32308 32312 32309	HM218248Z/10 HM218248Z/10 32218 32218 32218 32218 32218 32218 32218 HM218248Z/10 HM218248Z/10		Ch.1032242 - Ch.1032242 - Ch.1033748-15 Ch.1033748-15 -Ch.1033747 -Ch.1033747 -Ch.1033747 -Ch.1033747 -Ch.1033747 -Ch.1033747 Ch.1033748 - Ch.1033748 -
LS 110					
	R 650/RD 650/R 651/R 751 R 650/RD 650/R 651/R 751 RP 750 RP 750 TRAILING AXLE TRAILING AXLE	32308	32218 32218 32219 32219 32218 32218		
LS 111					
	AM 55 AM 55 AM 60 AM 60 AD 90 AD 90 AD 90 AD 90 AD 95 AD 95 AD 100 AD 100 TRAILING AXLE TRAILING AXLE TRAILING AXLE TRAILING AXLE TRAILING AXLE TRAILING AXLE	32311 32308 32312 32309	HM218248Z/10 HM218248Z/10 32218 32218 32219 32219 HM220149Z/10 HM220149Z/10 32218 32218 HM218248Z/10 HM218248Z/10 32218 32218		Ch.1032242 - Ch.1032242 - Ch.1033748-15 Ch.1033748-15 -Ch.1033747 -Ch.1033747 3 3 -Ch.1033747 -Ch.1033747 Ch.1033748-15 Ch.1033748-15 Ch.1033748-15 Ch.1033748-15

APPLICATION LISTINGS - TRUCK







A



SCANIA					
LS 141					
	AD 90 AD 90 AD 90 AD 90 AD 90 AD 90 AD 95 AD 95 AD 100 AD 100 TRAILING AXLE TRAILING AXLE TRAILING AXLE TRAILING AXLE TRAILING AXLE TRAILING AXLE	32312 32309	32218 32218 HM218248Z/10 HM218248Z/10 32218 32218 32219 32219 HM220149Z/10 HM220149Z/10 32218 32218 HM218248Z/10 HM218248Z/10 32218 32218		-Ch.1033747 -Ch.1033747 Ch.1033748-15 Ch.1033748-15 -Ch.1033747 -Ch.1033747 Ch.1033748-15 Ch.1033748-15
LT 110					
	R 650/RD 650/R 651/R 751 R 650/RD 650/R 651/R 751	32308	32218 32218		
LT 111					
	AM 55 AM 55 AM 60 AM 60 AD 90 AD 90 AD 90 AD 90 AD 90 AD 90 AD 90 AD 90 AD 90 AD 95 AD 95 AD 95 AD 95 AD 100 AD 100	32311 32308 32312 32309	HM218248Z/10 HM218248Z/10 32218 32218 HM218248Z/10 HM218248Z/10 32218 32218 32219 32219 32219 32219 HM220149Z/10 HM220149Z/10		Ch.1032242 - Ch.1032242 - Ch.1033748-15 Ch.1033748-15 -Ch.1033747 -Ch.1033747 2300mm wide ch. 15 2300mm wide ch. 15 3 3 4 4
LT 146					
	AD 95 AD 95 AD 100 AD 100	32312 32309	32219 32219 HM220149Z/10 HM220149Z/10		

APPLICATION LISTINGS - TRUCK









					
SCANIA					
P 82 M/H					
AM 55		32311		I	⊗ -Ch.1097602SSS, 4246024SN
AM 55		32308		O	⊗ -Ch.1097602SSS, 4246024SN
AM 55		32311		I	⊗ Ch.1097603SSS/4238514SN -
AM 55		32308		O	⊗ Ch.1097603SSS/4238514SN -
AM 55		32311		I	⊗ -Ch.1105665SSS, 4238514SN
AM 55		32308		O	⊗ -Ch.1105665SSS, 4238514SN
AM 55		32311		I	⊗ Ch.1105666SSS/4238515SN -
AM 55		32308		O	⊗ Ch.1105666SSS/4238515SN -
AM 60		32312		I	
AM 60		32309		O	
AD 80			32216	I	⊗
AD 80			33215	O	⊗
AD 80			32216	I	⊗
AD 80			32215	O	⊗
AD 90/ADA 90			HM218248Z/10	I	⊗ 15
AD 90/ADA 90			HM218248Z/10	O	⊗ 15
AD 90/ADA 90			HM218248Z/10	I	⊗ 2300mm wide ch. 15
AD 90/ADA 90			HM218248Z/10	O	⊗ 2300mm wide ch. 15
AD 90/ADA 90			32218	I	⊗ 20/22.5", -Ch.1103187SSS, 4248317SN
AD 90/ADA 90			32218	O	⊗ 20/22.5", -Ch.1103187SSS, 4248317SN
AD 90/ADA 90			HM218248Z/10	I	⊗ 20/22.5", Ch.1103188SSS, 4248318SN-14 15
AD 90/ADA 90			HM218248Z/10	O	⊗ 20/22.5", Ch.1103188SSS, 4248318SN-14 15
AD 90/ADA 90			32218	I	⊗ 24" 15
AD 90/ADA 90			32218	O	⊗ 24" 15
P 92 H [6X2]					
	TRAILING AXLE AS 90		HM218248Z/10	I	⊗ 15
	TRAILING AXLE AS 90		HM218248Z/10	O	⊗ 15
P 112 H/E, R 112 H/E					
AM 55		32311		I	⊗ -Ch.1097602SSS, 4246024SN
AM 55		32308		O	⊗ -Ch.1097602SSS, 4246024SN
AM 55		32311		I	⊗ Ch.1097603SSS/4238514SN -
AM 55		32308		O	⊗ Ch.1097603SSS/4238514SN -
AM 55		32311		I	⊗ -Ch.1105665SSS, 4238514SN
AM 55		32308		O	⊗ -Ch.1105665SSS, 4238514SN
AM 55		32311		I	⊗ Ch.1105666SSS/4238515SN -
AM 55		32308		O	⊗ Ch.1105666SSS/4238515SN -
P/R 112 H [6X2]					
	TRAILING AXLE/AS 90		HM218248Z/10	I	⊗ 15
	TRAILING AXLE/AS 90		HM218248Z/10	O	⊗ 15
	TRAILING AXLE/AS 90		32218	I	⊗
	TRAILING AXLE/AS 90		32218	O	⊗
P/R 112 M [6X2]					
	TRAILING AXLE/ASA 60		32312	I	
	TRAILING AXLE/ASA 60		32309	O	

APPLICATION LISTINGS - TRUCK















A



				 			
SCANIA							
P/R/T 113, P 113 H/E/M							
	AM 56	JF6049/10					
	AM 56	32309					
	AM 56	32312					
	AM 56	32309					
	AM 61	32312					
	AM 61	32309					
	AM 70	JF7049A/10					
	AD 80		32216				
	AD 80		33215				
	AD 80		32216				
	AD 80		32215				
	AD 90/ADA 90		32218				
	AD 90/ADA 90		32218				
	AD 90/ADA 90		32218				
	AD 90/ADA 90		32218				
	AD 90/ADA 90		32218				
	AD 90/ADA 90		HM218248Z/10				
	AD 90/ADA 90		HM218248Z/10				
	AD 100		HM220149Z/10				
	AD 100		HM220149Z/10				
	ARA 56		JF6049/10				
	ARA 56		32309				
	ARA 61		32312				
	ARA 61		32309				
	TRAILING AXLE/AS 60		32312				
	TRAILING AXLE/AS 60		32309				
	TRAILING AXLE/ASA 70		JF7049A/10				
	TRAILING AXLE/ASA 80		32216				
	TRAILING AXLE/ASA 80		33215				
	TRAILING AXLE/AS 90		HM218248Z/10				
	TRAILING AXLE/AS 90		HM218248Z/10				
R 113 H/E/M, T 113 H/E							
	AM 56	JF6049/10					
	AM 56	32309					
	AM 56	32312					
	AM 56	32309					
	AM 61	32312					
	AM 61	32309					
	AM 70	JF7049A/10					
	AD 80		32216				
	AD 80		33215				
	AD 80		32216				
	AD 80		32215				
	AD 90/ADA 90		32218				
	AD 90/ADA 90		32218				
	AD 90/ADA 90		32218				
	AD 90/ADA 90		32218				
	AD 90/ADA 90		32218				
	AD 90/ADA 90		HM218248Z/10				
	AD 90/ADA 90		HM218248Z/10				
	AD 100		HM220149Z/10				
	AD 100		HM220149Z/10				
	ARA 56		JF6049/10				
	ARA 56		32309				
	ARA 61		32312				

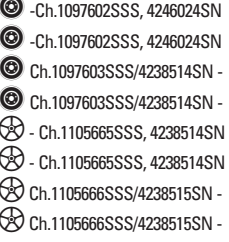

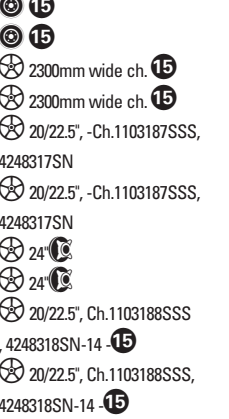

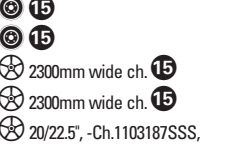

















































































APPLICATION LISTINGS - TRUCK



					
SCANIA					
R 113 H/E/M, T 113 H/E ...					
	ARA 61 TRAILING AXLE/AS 60 TRAILING AXLE/AS 60 TRAILING AXLE/ASA 70 TRAILING AXLE/ASA 80 TRAILING AXLE/ASA 80 TRAILING AXLE/AS 90 TRAILING AXLE/AS 90		32309 32312 32309 JF7049A/10 32216 33215 HM218248Z/10 HM218248Z/10		Twin steer  
R 142 M [4X2] / R 142 H/E					
	AM 55 AM 55 AM 55 AM 55 AM 55 AM 55 AM 55 AM 55	32311 32308 32311 32308 32311 32308 32311 32308			
R 142 [4X2] [6X4]					
	AM 60 AM 60 AM 70 AD 90/ADA 90 AD 90/ADA 90 AD 90/ADA 90 AD 90/ADA 90 AD 90/ADA 90 AD 90/ADA 90 AD 90/ADA 90 AD 90/ADA 90 AD 90/ADA 90 AD 90/ADA 90 AD 90/ADA 90 AD 100 AD 100 ARA 55 ARA 55 TRAILING AXLE/ASA 60 TRAILING AXLE/ASA 60 TRAILING AXLE/ASA 70	32312 32309 JF7049A/10	HM218248Z/10 HM218248Z/10 HM218248Z/10 HM218248Z/10 32218 32218 32218 32218 HM218248Z/10 HM218248Z/10 HM220149Z/10 HM220149Z/10 32311 32308 32312 32309 JF7049A/10		
R 142 [6X2]					
	AM 60 AM 60 AM 70 AD 90/ADA 90 AD 90/ADA 90 AD 90/ADA 90 AD 90/ADA 90 AD 90/ADA 90	32312 32309 JF7049A/10	HM218248Z/10 HM218248Z/10 HM218248Z/10 HM218248Z/10 32218		

























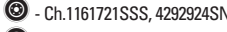
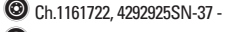

APPLICATION LISTINGS - TRUCK

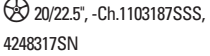
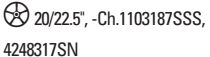
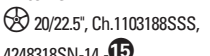
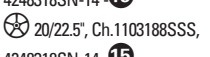

					
SCANIA					
R 142 [6X2] ...					
4248317SN AD 90/ADA 90 4248317SN AD 90/ADA 90 AD 90/ADA 90 AD 90/ADA 90 AD 90/ADA 90 AD 100 AD 100 ARA 55 ARA 55 TRAILING AXLE/ASA 60 TRAILING AXLE/ASA 60 TRAILING AXLE/ASA 70 TRAILING AXLE TRAILING AXLE			32218 32218 32218 HM218248Z/10 HM218248Z/10 HM220149Z/10 HM220149Z/10 32311 32308 32312 32309 JF7049A/10 HM218248Z/10 HM218248Z/10	            	20/22.5", -Ch.1103187SSS, 24"  24"  20/22.5", Ch.1103188SSS, 4248318SN-14 -  20/22.5", Ch.1103188SSS, 4248318SN-14 - 
R 142 H [6X2]					
	TRAILING AXLE TRAILING AXLE		HM218248Z/10 HM218248Z/10	 	 
R 142 M [6X4]					
	AD 80 AD 80 AD 80 AD 80		32216 33215 32216 32215	   	   
R 142 M [6X2]					
	TRAILING AXLE TRAILING AXLE		32312 32309	 	 
R 143					
	AM 56 AM 56 AM 56 AM 56 AM 61 AM 61 AM 70 AM 70 AM 70 AD 80 AD 80 AD 80 AD 80 AD 90 AD 90 AD 90 AD 90 AD 90 AD 90 ADA 90	JF6049/10 32309 32312 32309 32312 32309 JF7049A/10 JF7049A/10 JF7049A/10	32216 33215 32216 32215 HM218248Z/10 HM218248Z/10 32218 32218 32218 32218 HM218248Z/10	                  	                   24"  - Ch.1161721SSS, 4292924SN Ch.1161722, 4292925SN-37 -        

APPLICATION LISTINGS - TRUCK

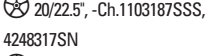
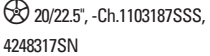
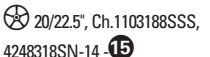
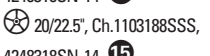

		 		
SCANIA				
R 143 ...				
	ADA 90		HM218248Z/10	
	ADA 90		32218	
	ADA 90		32218	
	ADA 90		32218	
	ADA 90		32218	
	AD 100		HM220149Z/10	
	AD 100		HM220149Z/10	
	AD 100		HM220149Z/10	
	AD 100		HM220149Z/10	
	ARA 56		JF6049/10	
	ARA 56		32309	
	ARA 61		32312	
	ARA 61		32309	
	ASA 70		JF7049A/10	
	ASA 70		JF7049A/10	
	TRAILING AXLE/AS 60		32312	
	TRAILING AXLE/AS 60		32309	
	TRAILING AXLE/ASA 80		32216	
	TRAILING AXLE/ASA 80		33215	
	TRAILING AXLE/AS 90		HM218248Z/10	
	TRAILING AXLE/AS 90		HM218248Z/10	
R 143 E/H/M, T 143 H				
	AM 56	JF6049/10		
	AM 56	32309		
	AM 56	32312		
	AM 56	32309		
T 82 H [4X2]				
	AD 90		HM218248Z/10	
	AD 90		HM218248Z/10	
	AD 90		32218	
	AD 90		32218	
	AD 90		HM218248Z/10	
	AD 90		HM218248Z/10	
T 82 H [6X2]				
	AM 60	32312		
	AM 60	32309		
	AD 90		HM218248Z/10	
	AD 90		HM218248Z/10	
	AD 90		32218	
	AD 90		32218	
	AD 90		HM218248Z/10	
	AD 90		HM218248Z/10	
	AD 90		HM218248Z/10	
	TRAILING AXLE/AS 90		HM218248Z/10	







































































APPLICATION LISTINGS - TRUCK



SCANIA											
T 82 H [6X2] ...											
	TRAILING AXLE/AS 90				HM218248Z/10						15
	TRAILING AXLE/AS 90				HM218248Z/10						15
	TRAILING AXLE/AS 90				HM218248Z/10						15
T 82 M [4X2]											
	AM 55	32311									-Ch.1097602SSS, 4246024SN
	AM 55	32308									-Ch.1097602SSS, 4246024SN
	AM 55	32311									Ch.1097603SSS, 4246025SN-17 -
	AM 55	32308									Ch.1097603SSS, 4246025SN-17 -
	AM 60	32312									
	AM 60	32309									
	AD 80				32216						
	AD 80				33215						
	AD 80				32216						
	AD 80				32215						
	AD 90				HM218248Z/10						
	AD 90				HM218248Z/10						
	AD 90				32218						20/22.5", -Ch.1103187SSS, 4248317SN
	AD 90				32218						20/22.5", -Ch.1103187SSS, 4248317SN
	AD 90				HM218248Z/10						20/22.5", Ch.1103188SSS, 4248318SN-14 - 15
	AD 90				HM218248Z/10						20/22.5", Ch.1103188SSS, 4248318SN-14 - 15
T 112 M [4X2]											
	AM 55	32311									-Ch.1097602 SSS/4246024 SN
	AM 55	32308									-Ch.1097602 SSS/4246024 SN
	AM 55	32311									Ch.1097603 SSS/4246025 SN-17 -
	AM 55	32308									Ch.1097603 SSS/4246025 SN-17 -
	AM 55	32311									-Ch.1105665SSS, 4238514SN
	AM 55	32308									-Ch.1105665SSS, 4238514SN
	AM 55	32311									Ch.1105666SSS/4238515SN -
	AM 55	32308									Ch.1105666SSS/4238515SN -
	AD 80				32216						
	AD 80				33215						
	AD 80				32216						
	AD 80				32215						
T 112 H/E											
	AM 55	32311									-Ch.1097602 SSS/4246024 SN
	AM 55	32308									-Ch.1097602 SSS/4246024 SN
	AM 55	32311									Ch.1097603 SSS/4246025 SN-17 -
	AM 55	32308									Ch.1097603 SSS/4246025 SN-17 -
	AM 55	32311									-Ch.1105665SSS, 4238514SN
	AM 55	32308									-Ch.1105665SSS, 4238514SN
	AM 55	32311									Ch.1105666SSS/4238515SN -
	AM 55	32308									Ch.1105666SSS/4238515SN -
T 112 [4X2, 6X2, 6X4]											
	AM 60	32312									
	AM 60	32309									
	AM 70	JF7049A/10									

APPLICATION LISTINGS - TRUCK



					
SCANIA					
T 112 [4X2, 6X2, 6X4] ...					
	AD 90 AD 90 AD 90/ADA 90 AD 90/ADA 90 AD 90/ADA 90 AD 90/ADA 90 AD 90/ADA 90 AD 90/ADA 90 AD 90/ADA 90 AD 100 AD 100		HM218248Z/10 HM218248Z/10 HM218248Z/10 HM218248Z/10 32218 32218 32218 32218 HM218248Z/10 HM218248Z/10 HM220149Z/10 HM220149Z/10	           	 15  15  2300mm wide ch. 15  2300mm wide ch. 15  24" 15  24" 15  20/22" 15 -Ch.1103187SSS, 428317SN  20/22" 15 -Ch.1103187SSS, 428317SN  20/22" 15 Ch.1033188SSS/ 4248318SN - 15  20/22" 15 Ch.1033188SSS/ 4248318SN - 15
T 112 [6X2]					
	TRAILING AXLE/AS 90 TRAILING AXLE/AS 90 TRAILING AXLE/AS 90 TRAILING AXLE/AS 90		HM218248Z/10 HM218248Z/10 32218 32218	   	 15  15  
T 142					
	AM 55 AM 55 AM 55 AM 55 AM 55 AM 55 AM 55 AM 55	32311 32308 32311 32308 32311 32308 32311 32308		       	 -Ch.1097602SSS, 4246024SN  -Ch.1097602SSS, 4246024SN  Ch.1097603SSS/4238514SN -  Ch.1097603SSS/4238514SN -  - Ch.1105665SSS, 4238514SN  - Ch.1105665SSS, 4238514SN  Ch.1105666SSS/4238515SN -  Ch.1105666SSS/4238515SN -
T 142 [4X2]					
	AM 60 AM 60 AM 70 AD 100 AD 100	32312 32309 JF7049A/10	HM220149Z/10 HM220149Z/10	    	
T 142 [6X2]					
	AM 60 AM 60 AM 70 AD 100 AD 100 TRAILING AXLE/AS 90 TRAILING AXLE/AS 90	32312 32309 JF7049A/10	HM220149Z/10 HM220149Z/10 HM218248Z/10 HM218248Z/10	      	 15  15
T 142 [6X4]					
	AM 60 AM 60 AM 70 AD 90/ADA 90	32312 32309 JF7049A/10	HM218248Z/10	   	 2300mm wide ch. 15



















APPLICATION LISTINGS - TRUCK

A



SCANIA											
T 142 [6X4] ...											
	AD 90/ADA 90 AD 100 AD 100			HM218248Z/10 HM220149Z/10 HM220149Z/10							2300mm wide ch. 15
T 142 E											
	AM 60 AM 60 AM 70	32312 32309 JF7049A/10									
T 142 M											
	AD 80 AD 80 AD 80 AD 80 AD 90/ADA 90 AD 90/ADA 90 AD 90/ADA 90 AD 90/ADA 90 AD 90/ADA 90 4248317SN AD 90/ADA 90 4248317SN AD 90/ADA 90 AD 90/ADA 90		32216 33215 32216 32215 HM218248Z/10 HM218248Z/10 HM218248Z/10 HM218248Z/10 32218 32218 32218 32218								⊗ ⊗ ⊗ ⊗ ⊗ 15 ⊗ 15 ⊗ 20/22.5", Ch.1103188SSS, 4248318SN-14 - 15 ⊗ 20/22.5", Ch.1103188SSS, 4248318SN-14 - 15 ⊗ 20/22.5", -Ch.1103187SSS, ⊗ 20/22.5", -Ch.1103187SSS, ⊗ 24" 15 ⊗ 24" 15
T 143											
	AM 61 AM 70 AM 70 AM 70 AD 80 AD 80 AD 80 AD 80 AD 90 AD 90 AD 90 AD 90 AD 90 ADA 90 ADA 90 ADA 90 ADA 90 ADA 90 ADA 90 AD 100 AD 100 AD 100 AD 100 ARA 56 ARA 56	32312 JF7049A/10 JF7049A/10 JF7049A/10	32216 33215 32216 32215 HM218248Z/10 HM218248Z/10 32218 32218 32218 32218 HM218248Z/10 HM218248Z/10 32218 32218 32218 32218 HM220149Z/10 HM220149Z/10 HM220149Z/10 HM220149Z/10 JF6049/10 32309								⊗ ⊗ 24" 15 ⊗ - Ch.1161721SSS, 4292924SN ⊗ Ch.1161722, 4292925SN-37 - ⊗ ⊗ ⊗ ⊗ ⊗ ⊗ 20/22.5" 15 ⊗ 20/22.5" 15 ⊗ 24" 15 178mm 15 ⊗ 24" 15 178mm 15 ⊗ 24" 15 203mm ⊗ 24" 15 203mm ⊗ 20/22.5" 15 ⊗ 20/22.5" 15 ⊗ 24" 15 178mm 15 ⊗ 24" 15 178mm 15 ⊗ 24" 15 203mm ⊗ 24" 15 203mm ⊗ 20/22.5" 15 ⊗ 20/22.5" 15 ⊗ 24" 15 -Ch.1180029SSS ⊗ 24" 15 -Ch.1180029SSS

APPLICATION LISTINGS - TRUCK

		 		
SCANIA				
T 143 ...				
	ARA 61 ARA 61 ASA 70 ASA 70 TRAILING AXLE/AS 60 TRAILING AXLE/AS 60 TRAILING AXLE/ASA 80 TRAILING AXLE/ASA 80 TRAILING AXLE/AS 90 TRAILING AXLE/AS 90		32312 32309 JF7049A/10 JF7049A/10 32312 32309 32216 33215 HM218248Z/10 HM218248Z/10	  - Ch.1161721SSS, 4292924SN  Ch.1161722, 4292925SN-37 -    
SEDDON ATKINSON				
201 SERIES				
	1984 - 1984 - INTERNATIONAL [RA 57] INTERNATIONAL [RA 57] EATON 38 DS EATON 38 DS	H212749/10 HM204049/10 H212749/10 H212749/10	594/592A 575/572 594A/592A 575/572 594A/592A HM204049/10	 -Ch.51013 -Ch.51013
211 SERIES				
	EATON 1800, 1&2 SPEED EATON 1800, 1&2 SPEED	H212749/10 HM212047/11	594A/592A 575/572	
300 SERIES				
	13T 13T INTERNATIONAL [RA 57] INTERNATIONAL [RA 57] EATON 38 DS EATON 38 DS	H212749/10 H212749/10	HM220149/10 HM220149/10 594A/592A 663/653 594A/592A 575/572	 
301 SERIES				
	SEDDON 110 SEDDON 110 ROCKWELL [S180E] ROCKWELL [S180E] ROCKWELL [S180E] ROCKWELL [S180E] KIRKSTALL KIRKSTALL	H212749/10 H212749/10	32218 32217 32219 32217 33019 JM716649/10 H212749/10 HM204049/10	 Ch.83772 - Ch.83772 -





















APPLICATION LISTINGS - TRUCK

A













     					
SEDDON ATKINSON					
311 SERIES					
	EATON EATON ROCKWELL [S180] ROCKWELL [S180] INTERNATIONAL [RA 57] INTERNATIONAL [RA 57]	H212749/10 H212749/10	594A/592A 575/572 594A/592A 580/572 594A/592A 663/653		
400 SERIES					
	SEDDON, 13T SEDDON, 13T		HM220149/10 HM220149/10		
401 SERIES					
	EATON 38 DS EATON 38 DS INTERNATIONAL [RA 57] INTERNATIONAL [RA 57] INTERNATIONAL [RA 452] INTERNATIONAL [RA 452]	H212749/10 H212749/10	594A/592A 575/572 594A/592A 580/572 594A/592A 663/653		
VARIOUS					
	EATON 18/19 EATON 18/19 ROCKWELL [S160E/S180E] ROCKWELL [S160E/S180E]		594A/592A 575/572 32219 32217		
TATRA					
T815					
	8T GAW 13T GAW 13T GAW	48290	30221M JHM720249/10		1997- 1997- 1997-
VOLVO					
F 7 [4X2]					
	FAT 6.5 FAT 6.5 FAT 6.5 FAT 6.5 FAT 6.5 FAT 6.5 FAT 6.5 FAT 6.5 FAT 6.5 FAT 6.5 FAT 6.5 FAT 6.5	6386/6320 537/532X JF7049A/10 39580/39520 6386/6320 537/532X 6386/6320 537/532X JF7049A/10 39580/39520 JF7049A/10 39580/39520	683/672		 -Ch.27087 -Ch.27087 Ch.27088 - Ch.27088 - 20"  -Ch.27087 20"  -Ch.27087 22"  -Ch.27087 22"  -Ch.27087 Ch.27088 - Ch.27088 -



APPLICATION LISTINGS - TRUCK



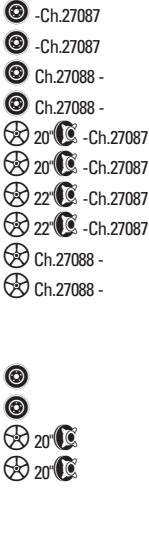





							
VOLVO							
F 7 [4X2] ...							
				663/653 683/672 663/653 683/672 663/653			
F 7 [6X2]							
	FAT 6.5 FAT 6.5 FAT 6.5 FAT 6.5 FAT 6.5 FAT 6.5 FAT 6.5 FAT 6.5 FAT 6.5 FAT 6.5 FAT 6.5 FAT 6.5 FAT 6.5 TRAILING AXLE TRAILING AXLE TRAILING AXLE TRAILING AXLE TRAILING AXLE TRAILING AXLE TRAILING AXLE TRAILING AXLE	6386/6320 537/532X JF7049A/10 39580/39520 6386/6320 537/532X 6386/6320 537/532X JF7049A/10 39580/39520 JF7049A/10 39580/39520		683/672 663/653 683/672 663/653 594/592A 580/572 683/672 663/653 HM215249/10 33213 JF7049A/10 39580/39520			
F 7 [6X4, 8X2, 8X4]							
	FAT 6.5 FAT 6.5 FAT 6.5 FAT 6.5 FAT 6.5 FAT 6.5 FAT 6.5 FAT 6.5 FAT 6.5 FAT 6.5 FAT 6.5	6386/6320 537/532X JF7049A/10 39580/39520 6386/6320 537/532X 6386/6320 537/532X JF7049A/10 39580/39520 JF7049A/10 39580/39520		683/672 663/653 683/672 663/653 683/672 663/653			



APPLICATION LISTINGS - TRUCK

A



     	
VOLVO	
F 10 [6X2]	
TRAILING AXLE	JF7049A/10
TRAILING AXLE	39580/39520
TRAILING AXLE	HM218248Z/10
TRAILING AXLE	33213
TRAILING AXLE	594/592A
TRAILING AXLE	580/572
TRAILING AXLE	683/672
TRAILING AXLE	663/653
TRAILING AXLE	683/672
TRAILING AXLE	663/653
TRAILING AXLE	683/672
TRAILING AXLE	663/653
TRAILING AXLE	683/672
TRAILING AXLE	749A/742
TRAILING AXLE	HM215249/10
TRAILING AXLE	33213
TRAILING AXLE	JF7049A/10
TRAILING AXLE	39580/39520
F 10 [4X2, 6X2]	
RAN 71/RTN 71/RTN 72	683/672
RAN 71/RTN 71/RTN 72	663/653
RAN 81/RTN 80/RTN 87	683/672
RAN 81/RTN 80/RTN 87	749A/742
	HM220149Z/10
	HM218248Z/10
	32219
	32219
F 10 [4X2, 6X2, 6X4]	
FAT 6.5	6386/6320
FAT 6.5	537/532X
FAT 6.5	JF7049A/10
FAT 6.5	39580/39520
FAT 7.5	JF7049A/10
FAT 7.5	39580/39520
	683/672
	663/653
F 12 [4X2, 6X2, 6X4]	
FAT 6.5	6386/6320
FAT 6.5	537/532X
FAT 6.5	JF7049A/10
FAT 6.5	39580/39520
	683/672
	663/653
	683/672
	663/653
	683/672
	749A/742
	32219
RAN 81/RTN 80/RTN 87	32219
RAN 81/RTN 80/RTN 87	32219
	-Ch.36763
	-Ch.36763
	Ch.36764-
	Ch.36764-
	20" 4
	20" 4
	4
	4
	24" 4
	24" 4
	3
	3





APPLICATION LISTINGS - TRUCK



VOLVO					
F 12 [4X2, 6X2, 6X4, 8X2, 8X4]					
	FAT 7.5 FAT 7.5 FAT 7.5 FAT 7.5 RAN 71/RTN 71/RTN 72 RAN 71/RTN 71/RTN 72	JF7049A/10 39580/39520 JF7049A/10 39580/39520	HM220149Z/10 HM218248Z/10		-Ch.65820 -Ch.65820 ⊗ 20/21" ⊕ -Ch.65820 ⊗ 20/21" ⊕ -Ch.65820 ③ ③
F 12 [6X2]					
	TRAILING AXLE TRAILING AXLE TRAILING AXLE TRAILING AXLE TRAILING AXLE TRAILING AXLE TRAILING AXLE TRAILING AXLE	JF7049A/10 39580/39520 HM218248Z/10 33213 594/592A 580/572 HM215249/10 33213		S Ride S Ride Special models, Super volume Special models, Super volume ⊗ -Ch.22914 ⊗ -Ch.22914 ⊕ ⊕	
F 12 [6X2, 8X2]					
	TRAILING AXLE TRAILING AXLE TRAILING AXLE TRAILING AXLE TRAILING AXLE TRAILING AXLE	683/672 663/653 683/672 663/653 683/672 749A/742		⊗ Ch.22915- ⊗ Ch.22915- ⊗ 20" ⊕ -Ch.27087 ⊗ 20" ⊕ -Ch.27087 ⊗ 24" ⊕ -Ch.27087 ⊗ 24" ⊕ -Ch.27087	
F 16 [4X2, 6X2]					
		683/672 749A/742		⊗ 24" ⊕ ④ ⊗ 24" ⊕ ④	
F 16 [4X2, 6X2, 6X4]					
	FAT 6.5/FAT 7.5/FAT 8.0 FAT 6.5/FAT 7.5/FAT 8.0 RTN 371/RTN 373/RAN 471 RTN 371/RTN 373/RAN 471	JF7049A/10 39580/39520 JF7049A/10 39580/39520	683/672 663/653 683/672 663/653 HM220149Z/10 HM218248Z/10		⊗ 20/24" ⊗ 20/24" ⊗ 20" ⊕ ④ ⊗ 20" ⊕ ④ ⊗ ④ ⊗ ④ ⊗ ④ ⊗ ④ ⊗ 20" ⊕ ⊕ ⊗ 20" ⊕ ⊕ ⊗ 24" ⊕ ⊕ ⊗ 24" ⊕ ⊕ ⊗ 20" ⊕ ⊕ ⊗ 20" ⊕ ⊕ ⊗ 24" ⊕ ⊕ ⊗ 24" ⊕ ⊕ ⊗ 20" ⊕ ⊕ ⊗ 20" ⊕ ⊕
F 16 [6X4]					
	TRAILING AXLE TRAILING AXLE TRAILING AXLE TRAILING AXLE TRAILING AXLE TRAILING AXLE	683/672 663/653 683/672 749A/742 683/672 663/653 683/672 749A/742 JF7049A/10 39580/39520		⊗ 20" ⊕ ④ ⊗ 20" ⊕ ④ ⊗ 24" ⊕ ④ ⊗ 24" ⊕ ④ ⊗ ④ ⊗ ④ ⊗ ④ ⊗ ④ ⊗ 20" ⊕ ⊕ ⊗ 20" ⊕ ⊕ ⊗ 24" ⊕ ⊕ ⊗ 24" ⊕ ⊕ ⊗ 20" ⊕ ⊕ ⊗ 20" ⊕ ⊕ ⊗ 24" ⊕ ⊕ ⊗ 24" ⊕ ⊕ ⊗ 20" ⊕ ⊕ ⊗ 20" ⊕ ⊕	









































APPLICATION LISTINGS - TRUCK

A















     			
VOLVO			
F 16 [6X4] ...			
TRAILING AXLE TRAILING AXLE TRAILING AXLE TRAILING AXLE	683/672 663/653 JF7049A/10 39580/39520	 	 BGT 18/21/26  Rear  BGT 18/21/26  Rear  S-Ride, Rear Steer  S-Ride, Rear Steer
F 84/85			
FAT 5.0 RATS 80 RATS 80 RATS 81 RATS 81	32308 594/592A 580/572 594/592A 580/572		 363067  363067
F 86/F 87			
FAT 5.0 FAT 6.0 FAT 6.0 BAT 10 BAT 10 BAT 11 BAT 11	32308 6386/6320 537/532X 594/592A 580/572 683/672 663/653		57mm 
F 88/FB 88/G 88			
FAT 6.0 FAT 6.0 FAT 6.0 FAT 6.0 FAT 6.0	6386/6320 537/532X 683/672 663/653 32219 32219		 4 Ch.36634-  4 Ch.36634-  3  3
F 88/G 88 [6X2]			
TRAILING AXLE TRAILING AXLE	594/592A 580/572		
F 89/G 89 [4X2, 6X2, 6X4]			
	6386/6320 537/532X 683/672 663/653		 4  4
F 89/G 89 [4X2, 6X2]			
	32219 32219		 3  3
F 89/G 89 [6X2]			
TRAILING AXLE TRAILING AXLE TRAILING AXLE TRAILING AXLE TRAILING AXLE TRAILING AXLE	594/592A 580/572 594/592A 580/572 683/672 663/653		-Ch.6997 -Ch.6997  Ch.6998-  Ch.6998-  Ch.6998 -  Ch.6998 -



APPLICATION LISTINGS - TRUCK









							
VOLVO							
F 406/407/408							
		32209 32206 32210 32207		33014 33012 33014 33012			14 14 13 13 -Ch.7050 -Ch.7050 Ch.7051 - Ch.7051 -
F 607/608/609/610							
		32210 32207		33015 33013 33015 33013			-Ch.23510 -Ch.23510 Ch.23511 - Ch.23511 -
F 611							
		32211 32208 JM207049/10 32208					-Ch.2376 -Ch.2376 Ch.2377 - Ch.2377 -
F 612/613							
		32211 32208 JM207049/10 32208					-Ch.6450 -Ch.6450 Ch.6451 - Ch.6451 -
F 614							
		32211 32208 JM207049/10 32208					-Ch.703 -Ch.703 Ch.704 - Ch.704 -
F 611/612/613/614							
				33018 33015 33018 33015			-Ch.21671 -Ch.21671 Ch.21672 - Ch.21672 -
F 615/616/617							
	FAT 6.5 FAT 6.5 BAT 10.9 BAT 10.9	HM212044/11 JM205149/10 6386/6320 537/532X JF7049A/10 39580/39520		594/592A 580/572 594/592A 580/572 594/592A 580/572			-Ch.3145 -Ch.3145 Ch.3146 - Ch.3146 - Ch.6872 - Ch.6872 - -Ch.2728 -Ch.2728 Ch.2729-Ch.6871 Ch.2729-Ch.6871 Ch.6872 - Ch.6872 -

APPLICATION LISTINGS - TRUCK













































A



     	
VOLVO	
FB 86	
FAT 6.0 FAT 6.0 BAT 11 BAT 11 TRAILING AXLE TRAILING AXLE TRAILING AXLE TRAILING AXLE TRAILING AXLE TRAILING AXLE	6386/6320 537/532X 683/672 663/653 594/592A 580/572 594/592A 580/572 683/672 663/653
FH 12	
TRAILING AXLE TRAILING AXLE	JF7049A/10 39580/39520 JF7049A/10 39580/39520 683/672 663/653
FH 12 [4X2, 6X2, 6X4]	
CTN 372 CTN 372 RAN 471 RAN 471 TRAILING AXLE TRAILING AXLE TRAILING AXLE TRAILING AXLE TRAILING AXLE TRAILING AXLE	683/672 663/653 HM220149Z/10 HM218248Z/10 HM220149Z/10 HM218248Z/10 JF7049A/10 39580/39520 683/672 663/653 683/672 663/653
FH 12 [4X2, 6X2, 6X4, 8X4]	
	683/672 663/653
FH 16	
TRAILING AXLE TRAILING AXLE	JF7049A/10 39580/39520 JF7049A/10 39580/39520 JF7049A/10 39580/39520 JF7049A/10 39580/39520 683/672 663/653

APPLICATION LISTINGS - TRUCK



					
VOLVO					
FH 16 [4X2, 6X2, 6X4, 8X4]					
			683/672 663/653 683/672 663/653		-Ch. A276505, -B190637 -563621 -Ch. A276505, -B190637 -563621  
FH 16 [4X2, 6X2, 6X4]					
	CTN 372 CTN 372 RAN 471 RAN 471 TRAILING AXLE TRAILING AXLE TRAILING AXLE TRAILING AXLE TRAILING AXLE		683/672 663/653 HM220149Z/10 HM218248Z/10 HM220149Z/10 HM218248Z/10 JF7049A/10 39580/39520 683/672 663/653 683/672 663/653		 10 -Ch.A291151  10 -Ch.A291151  2-3  2-3  3  3  7 -Ch.A276505, -B190637 -563621  7 -Ch.A276505, -B190637 -563621  5 -Ch.A276505, -B190637 -563621  5 -Ch.A276505, -B190637 -563621  5 -Ch.A276505, -B190637 -563621  5  5 
FL 6 / FL 608-FL 612					
	FAT 4.1 FAT 4.1 FAT 4.7 FAT 4.7	EK50044 33207 33208 33208	47678/47620 39590/39520		Ch.B166080- Ch.B166080- Ch.B170986-  6774825, FAT 4.7  6774825, FAT 4.7
FL 6 / FL 612-FL 615					
	FAT 5.0/FAT 5.6	33208	EK50005 33115		  Ch.B166080- FAT 5.0. Ch.B166080 FAT 5.0. Ch.B166080
FL 6 / FL 616-FL 626					
		JF7049A/10 39580/39520 JF7049A/10 39580/39520 JF7049A/10 39580/39520 JF7049A/10 39580/39520 JF7049A/10 39580/39520			Ch.B166080- Ch.B166080-   Ch.B166080-   Ch.B166080-  335mm bolts circle dia. Ch.B166080-  335mm bolts circle dia. Ch.B166080-  20  -Ch.B169139  20  -Ch.B169139  Ch.B169140-  Ch.B169140-
FL6 [4X2, 6X2, 6X4]					
			683/672 663/653		Ch.B169140 - B 190331 Ch.B169140 - B 190331



APPLICATION LISTINGS - TRUCK





































































VOLVO							
FL 6 / FL 618-FL 619							
	BAT 10.9/BAT 11.2/BAT 13.0		594/592A				335mm bolts circle dia. Ch.B166080 - B169139
	BAT 10.9/BAT 11.2/BAT 13.0		580/572				335mm bolts circle dia. Ch.B166080 - B169139
FL 6 / FL 616-FL 617							
			594/592A				335mm bolts circle dia.
			580/572				335mm bolts circle dia.
FL6 / FL 616-626 [4X2]							
			594/592A				Ch.B166080-
			580/572				Ch.B166080-
			594/592A				335mm bolts circle dia.
			580/572				-Ch.B169139 335mm bolts circle dia.
FL6							
	TRAILING AXLE		33208				WTT - D275, Ch.B166080-
FL 608-612							
	FAT 4.1	EK50044					
	FAT 4.1	33207					
	FAT 4.7	EK50044					
	FAT 4.7	33207					
			47678/47620				6774825, 6795528
			39590/39520				6774825, 6795528
FL 608-611							
			47678/47620				
			39590/39520				
FL 608-615							
			33208				S 60945, S60990, S60993, S61208, S61230
FL 612							
	FAT 4.1	EK50044					S 60677, S 60936
	FAT 4.1	33207					S 60677, S 60936
	FAT 4.7	EK50044					S 60677, S 60936
	FAT 4.7	33207					S 60677, S 60936
FL 612-614							
	FAT 5.0/FAT 5.6	33208					
			EK50005				
			33115				
			33018				
			33115				
			EK50005				
			33015				
							Vehicle with fixed construction
							Vehicle with fixed construction
							Vehicle without fixed construction
							Vehicle without fixed construction



APPLICATION LISTINGS - TRUCK



					
VOLVO					
FL 612-615					
	FAT 5.0/FAT 5.6	33208		 	
FL 616-617					
		JF7049A/10 39580/39520	594/592A 580/572		
FL 616-619					
	TRAILING AXLE TRAILING AXLE	JF7049A/10 39580/39520 JF7049A/10 39580/39520	594/592A 580/572 594/592A 580/572 JF7049A/10 39580/39520	      	⊗ 335mm bolts circle dia. ⊗ 335mm bolts circle dia. ⊗ 20"  ⊗ 20"  ⊗ 335mm bolts circle dia. ⊗ 335mm bolts circle dia. ⊗ 20"  ⊗ 20" 
FL 618-619					
	BAT 10.9/BAT 11.2 BAT 10.9/BAT 11.2 BAT 10.9/BAT 11.2 BAT 10.9/BAT 11.2 BAT 11.5 BAT 11.5 BAT 11.5/BAT 13.0 BAT 11.5/BAT 13.0 BAT 11.5/BAT 13.0 BAT 11.5/BAT 13.0		594/592A 580/572 594/592A 580/572 594/592A 580/572 683/672 663/653 683/672 663/653	               	⊗ 335mm bolts circle dia. ⊗ 335mm bolts circle dia. ⊗ 335mm bolts circle dia. ⊗ 335mm bolts circle dia. ⊗ 335mm bolts circle dia.  ⊗ 335mm bolts circle dia.  ⊗ 335mm bolts circle dia.  ⊗ 335mm bolts circle dia.  BAT, 11.5  ⊗ 335mm bolts circle dia.  BAT, 11.5  6x2 TAG [HENDRICKSON] 6x2 TAG [HENDRICKSON]
FL 7					
	TRAILING AXLE TRAILING AXLE TRAILING AXLE TRAILING AXLE	JF7049A/10 39580/39520 JF7049A/10 39580/39520 683/672 663/653	683/672 663/653 JF7049A/10 39580/39520	          	  ⊗ Earlier Models ⊗ Earlier Models  Earlier Models  Earlier Models ⊗ BGT 18/21/26  Rear ⊗ BGT 18/21/26  Rear ⊗ 7 ⊗ 7
FL 7 [8X2, 8X4]					
	RAEV 85B/CTEV 87 RAEV 85B/CTEV 87 RAEV 85B/CTEV 87 RAEV 85B/CTEV 87		683/672 663/653 683/672 663/653	   	⊗ ⊗  



APPLICATION LISTINGS - TRUCK

A









VOLVO							
FL 7 [4X2, 6X2, 6X4]							
	RAEV 85B/CTEV 87			683/672			
	RAEV 85B/CTEV 87			663/653			
	RAEV 85B/CTEV 87			683/672			
	RAEV 85B/CTEV 87			663/653			
	RAN 371/RTN 371/RTN 372			HM220149Z/10			
	RAN 371/RTN 371/RTN 372			HM218248Z/10			
	TRAILING AXLE			683/672			
	TRAILING AXLE			663/653			
	TRAILING AXLE			683/672			
	TRAILING AXLE			663/653			
	TRAILING AXLE			683/672			BGT 18/21/26 Rear
	TRAILING AXLE			663/653			BGT 18/21/26 Rear
	TRAILING AXLE			JF7049A/10			S-Ride, Rear Steer
	TRAILING AXLE			39580/39520			S-Ride, Rear Steer
	TRAILING AXLE			JF7049A/10			Rear Steer
	TRAILING AXLE			39580/39520			Rear Steer
FL 10 [6X4, 8X4]							
		33217					
		32312					
FL 10 [4X2, 6X2, 6X4, 8X4]							
				683/672			
				663/653			
FL 10 [4X2, 6X2, 6X4]							
	RAN 371/RTN 371/RTN 372			HM220149Z/10			
	RAN 371/RTN 371/RTN 372			HM218248Z/10			
	TRAILING AXLE			683/672			
	TRAILING AXLE			663/653			
	TRAILING AXLE			683/672			
	TRAILING AXLE			663/653			
	TRAILING AXLE			683/672			BGT 18/21/26 Rear
	TRAILING AXLE			663/653			BGT 18/21/26 Rear
	TRAILING AXLE			JF7049A/10			S-Ride, Rear Steer
	TRAILING AXLE			39580/39520			S-Ride, Rear Steer
	TRAILING AXLE			JF7049A/10			Rear Steer
	TRAILING AXLE			39580/39520			Rear Steer
FL 10 [4X2, 6X2, 8X2, 6X4, 8X4]							
	RAEV 85 B/CTEV 87			683/672			
	RAEV 85 B/CTEV 87			663/653			
	RAEV 85 B/CTEV 87			683/672			
	RAEV 85 B/CTEV 87			663/653			
FL 12							
		JF7049A/10					
		39580/39520					
FL 12 [4X2, 6X2, 6X4, 8X4]							
				683/672			
				663/653			
				683/672			
				663/653			





APPLICATION LISTINGS - TRUCK



													
VOLVO													
FL 12 [4X2, 6X2, 6X4, 8X4] ...													
	TRAILING AXLE TRAILING AXLE TRAILING AXLE TRAILING AXLE TRAILING AXLE TRAILING AXLE TRAILING AXLE TRAILING AXLE			JF7049A/10 39580/39520 683/672 663/653 683/672 663/653 JF7049A/10 39580/39520									
FM 7													
	RAN 371/CTN 372 RAN 371/CTN 372 TRAILING AXLE TRAILING AXLE		JF7049A/10 39580/39520 JF7049A/10 39580/39520			HM220149Z/10 HM218248Z/10 JF7049A/10 39580/39520							
FM 9													
	RAN 371/CTN 372 RAN 371/CTN 372 TRAILING AXLE TRAILING AXLE		JF7049A/10 39580/39520			HM220149Z/10 HM218248Z/10 JF7049A/10 39580/39520							
FM 10													
	RAN 371/CTN 372/CTN 472 RAN 371/CTN 372/CTN 472 TRAILING AXLE TRAILING AXLE		JF7049A/10 39580/39520 JF7049A/10 39580/39520			HM220149Z/10 HM218248Z/10 JF7049A/10 39580/39520							
FM 12													
	RAN 371/CTN 372/CTN 472 RAN 371/CTN 372/CTN 472 TRAILING AXLE TRAILING AXLE		JF7049A/10 39580/39520 JF7049A/10 39580/39520			HM220149Z/10 HM218248Z/10 JF7049A/10 39580/39520							
FS 7													
			JF7049A/10 39580/39520			594/592A 580/572 594/592A 580/572							





APPLICATION LISTINGS - TRUCK



VOLVO					
FS 7 ...					
	TRAILING AXLE TRAILING AXLE		683/672 663/653 683/672 663/653 594/592A 580/572 JF7049A/10 39580/39520		BAT 11.5/13.00, BLF-B BAT 11.5/13.00, BLF-B BAT 11.5, LUF-B BAT 11.5, LUF-B
FS 10					
		JF7049A/10 39580/39520			20° 20°
FS 10 [4X2, 6X4, 8X4]					
			683/672 663/653 HM220149Z/10 HM218248Z/10		20° 20° Construction vehicle Construction vehicle
N 7 [6X2]					
	TRAILING AXLE TRAILING AXLE TRAILING AXLE TRAILING AXLE TRAILING AXLE TRAILING AXLE		683/672 663/653 594/592A 580/572 683/672 663/653		 -Ch.11549 -Ch.11549 Ch.11550 - Ch.11550 -
N 7 [4X2, 6X2]					
	BAT 1.0 BAT 1.0 RAEV 85 B RAEV 85 B		594/592A 580/572 683/672 663/653		Ch.12001 - Ch.12001 -
N 7 [4X2, 6X2, 6X4]					
	FAT 5.0 FAT 5.0 FAT 6.5 FAT 6.5 FAT 6.5 FAT 6.5 FAT 7.5 FAT 7.5 BAT 1.3 BAT 1.3	32308 32308 6386/6320 537/532X JF7049A/10 39580/39520 JF7049A/10 39580/39520			20° -Ch.12099 -Ch.12099 Ch.12100 - Ch.12100 -
N 10 [6X2]					
	TRAILING AXLE TRAILING AXLE TRAILING AXLE TRAILING AXLE TRAILING AXLE TRAILING AXLE TRAILING AXLE TRAILING AXLE		683/672 663/653 594/592A 580/572 683/672 663/653 683/672 749A/742		20° 20° - Ch.46315 - Ch.46315 - Ch.46315 - Ch.46315 - Ch.46315 24° 24°





APPLICATION LISTINGS - TRUCK



VOLVO									
N 10 [4X2, 6X2]									
	BAT 1.0			594/592A					
	BAT 1.0			580/572					
N 10 [4X2, 6X2, 6X4]									
	FAT 5.0	32308							
	FAT 6.5	6386/6320							-Ch.52439
	FAT 6.5	537/532X							-Ch.52439
	FAT 6.5	JF7049A/10							Ch.52440-
	FAT 6.5	39580/39520							Ch.52440-
	FAT 7.5	JF7049A/10							
	FAT 7.5	39580/39520							
	FAT 7.5	JF7049A/10							35mm bolts circle dia.
		39580/39520							Ch.306000-
		JF7049A/10							35mm bolts circle dia.
		39580/39520							Ch.306000-
	BAT 1.3			683/672					20/24" Ch.30600-
	BAT 1.3			663/653					20/24" Ch.30600-
				683/672					
				663/653					
				683/672					
				749A/742					
				683/672					335mm bolts circle dia.
				663/653					Ch.306000-
				663/653					335mm bolts circle dia.
				663/653					Ch.306000-
	RAN 71/RTN 71/RTN 72			HM220149Z/10					
	RAN 71/RTN 71/RTN 72			HM218248Z/10					
	RAN 81/RTN 80/RTN 82/RTN 87			32219					
	RAN 81/RTN 80/RTN 82/RTN 87			32219					
N 12 [6X2]									
	TRAILING AXLE			594/592A					-Ch.8779
	TRAILING AXLE			580/572					-Ch.8779
	TRAILING AXLE			683/672					Ch.8780-
	TRAILING AXLE			663/653					Ch.8780-
	TRAILING AXLE			683/672					20" -Ch.12000
	TRAILING AXLE			663/653					20" -Ch.12000
	TRAILING AXLE			683/672					20" -Ch.12001
	TRAILING AXLE			663/653					20" -Ch.12001
	TRAILING AXLE			683/672					24" -Ch.12001
	TRAILING AXLE			749A/742					24" -Ch.12001
N 12 [4X2, 6X2, 6X4]									
	FAT 5.0	32308							
	FAT 6.5	6386/6320							-Ch.15169
	FAT 6.5	537/532X							-Ch.15169
	FAT 6.5	JF7049A/10							Ch.15170 -
	FAT 6.5	39580/39520							Ch.15170 -
	FAT 7.5/FAT 8.0	JF7049A/10							24"
	FAT 7.5/FAT 8.0	39580/39520							24"
				683/672					
				749A/742					



APPLICATION LISTINGS - TRUCK















































A



VOLVO					
N 12 [4X2, 6X2, 6X4] ...					
	BAT 1.0 BAT 1.0 BAT 1.3 BAT 1.3 RAN 71/RTN 71/RTN 72 RAN 71/RTN 71/RTN 72 RAN 81/RTN 80/RTN 82/RTN 87 RAN 81/RTN 80/RTN 82/RTN 87		683/672 663/653 594/592A 580/572 683/672 663/653 HM220149Z/10 HM218248Z/10 32219 32219		
N 84					
	RAEV 60/RATS 60 RAEV 60/RATS 60 RATS 80 RATS 80 RATS 81 RATS 81		582/572 42687/42620 594/592A 580/572 594/592A 580/572		
N 86					
	FAT 5.0 FAT 6.0 FAT 6.0 BAT 10 BAT 10 BAT 11 BAT 11 BAT 11 BAT 11 TRAILING AXLE TRAILING AXLE	32308 6386/6320 537/532X	594/592A 580/572 683/672 663/653 683/672 663/653 594/592A 580/572		57mm
N 88 [4X2] / NB 88 [6X2]					
	FAT 5.0 FAT 6.0 FAT 6.0	32308 6386/6320 537/532X			57mm
N 88 / NB 88					
			683/672 663/653 32219 32219		
NB 86					
	FAT 5.0 FAT 6.0 FAT 6.0 BAT 11 BAT 11 BAT 11 BAT 11	32308 6386/6320 537/532X	683/672 663/653 683/672 663/653		57mm

APPLICATION LISTINGS - TRUCK



							
VOLVO							
NB 88 [6X2]							
	TRAILING AXLE TRAILING AXLE TRAILING AXLE TRAILING AXLE			594/592A 580/572 683/672 663/653			
NH 12							
	CTN 372/RAN 471 CTN 372/RAN 471	JF7049A/10 39580/39520		HM220149Z/10 HM218248Z/10			 24"  20"  Ch.668771- 24"  20"  Ch.668771-
NL 10 S							
	FAT 6.5/FAT 6.7 FAT 6.5/FAT 6.7 FAT 7.5/FAT 8.0 FAT 7.5/FAT 8.0 FAT 9.0 FAT 9.0	JF7049A/10 39580/39520 JF7049A/10 39580/39520 33217 32312					   20/22.5/24"  20/22.5/24" Construction Vehicle Construction Vehicle
NL 10 S [4X2, 6X2, 6X4]							
	TRAILING AXLE TRAILING AXLE TRAILING AXLE TRAILING AXLE TRAILING AXLE TRAILING AXLE			683/672 663/653 683/672 663/653 683/672 749A/742 683/672 663/653 683/672 663/653 683/672 749A/742			   20"  4 20"  4 24"  4 24"  4   20"  20"  24"  24"
NL 12 S							
	FAT 6.5/FAT 6.7 FAT 6.5/FAT 6.7 FAT 7.5/FAT 8.0 FAT 7.5/FAT 8.0	JF7049A/10 39580/39520 JF7049A/10 39580/39520					   20/22.5/24"  20/22.5/24"
NL 12 S [4X2, 6X2, 6X4]							
	RTN 371/RTN 372/RAN 371 RTN 371/RTN 372/RAN 371 TRAILING AXLE TRAILING AXLE TRAILING AXLE TRAILING AXLE TRAILING AXLE TRAILING AXLE			683/672 663/653 683/672 749A/742 683/672 663/653 HM220149Z/10 HM218248Z/10 683/672 663/653 683/672 663/653 683/672 749A/742			 20"  4 20"  4 24"  4 24"  4   20"  20"  24"  24"

APPLICATION LISTINGS - TRAILER







A



APPLICATION LISTINGS - TRAILER



APPLICATION LISTINGS - TRAILER

			
	I	O	
ARVINMERITOR [ROR]			
TE 9000			
		EK50045	EK50046 9T
TE 9300			
		EK50045	EK50046 9.3T
TM 22000			
		HM218248/10	33213 22T
TM 22500			
		HM218248/10	33213 22.5T
TM 25000			
		HM218248/10	33213 25T
TM 33000			
		32220	32218 33T
LM 9000			
		NP569484/644537	NP569484/644537 9T
BPW			
H SERIES			
	1982-	33116	32310 6-6.5T
	1982-	33116	32310 8-9T
	1982-	33118	33213 10-12T
	1983-	32219	33215 13-14T
	1983-	32222	32314 16-18T
	1983-	32224	32316 20T
H SERIES ECO/ECO MAXX			
	1991-	33116	32310 6.5T
	1991-	33116	32310 8-9T
	1991-	33118	33213 10-12T
	1994-	32219	33215 13T
H SERIES ECOPLUS			
	2000-	33118	33213 8-12T
KH SERIES			
	1988-	33116	32310 6-6.5T
	1988-	33116	32310 8-9T
	1988-	33118	33213 10-12T
KH SERIES ECO/ECO MAXX			
	1991-	33116	32310 6.5T
	1991-	33116	32310 8-9T
	1991-	33118	33213 10-12T
KH SERIES ECOPLUS			
	2000-	33118	33213 8-12T



APPLICATION LISTINGS - TRAILER

A



			I	O	
BPW					
KR SERIES					
	1985-	33215	32310	6.4T	
	1985-	33116	32310	6-6.5T	
	1985-	33116	32310	8-9T	
	1985-	33118	33213	10-12T	
	1983-	32219	33215	13-14T	
KR SERIES ECO/ECO MAXX					
	1991-	33116	32310	6.5T	
	1991-	33116	32310	8-9T	
	1991-	33118	33213	10-12T	
KRBM 6408					
	1985-	33215	32310		
NH SERIES					
	1993-	33116	32310	6-6.5T	
	1993-	33116	32310	8-9T	
	1993-	33118	33213	10-12T	
NH SERIES ECO/ECO MAXX					
	1991-	33116	32310	6.5T	
	1991-	33116	32310	8-9T	
	1991-	33118	33213	10-12T	
NH SERIES ECOPLUS					
	2000-	33118	33213	8-12T	
NR SERIES					
	1982-	33116	32310	6-6.5T	
	1982-	33116	32310	8-9T	
	1982-	33118	33213	10-12T	
	1983-	32219	33215	13-14T	
NR SERIES ECO/ECO MAXX					
	1991-	33116	32310	6.5T	
	1991-	33116	32310	8-9T	
	1991-	33118	33213	10-12T	
R SERIES					
	1982-	33116	32310	6-6.5T	
	1982-	33116	32310	8-9T	
	1982-	33118	33213	10-12T	
R SERIES ECO/ECO MAXX					
	1991-	33116	32310	6.5T	
	1991-	33116	32310	8-9T	
	1991-	33118	33213	10-12T	
SH SERIES ECOPLUS					
	2000-	33118	33213	8-12T	
SKH SERIES ECOPLUS					
	2000-	33118	33213	8-12T	

APPLICATION LISTINGS - TRAILER

			
	I	O	
FRUEHAUF			
PROPAR [P SERIES]			
		HM518445/10	HM518445/10 9T
SMB OA / VA			
		EK50050	EK50050 9T
GIGANT [SAE]			
DH 4 05506 3334			
	1999	32212	33208 5.5T
DH 5/6 09010 3745			
	1999	33116	32310
DH 5/6 09010 4345			
	1998	33116	32310
DH 6 10010 4345			
		33118	33213 10T
DH 6 10008 3745			
		33118	33213 10T
GH 4 05506 3010			
	1999	32212	33208 5.5T
GNV 5 10010 3020			
	12/96	33118	33213
GNV 5 12010 3620			
	1996	33118	33213
GNVH 5 100010 3020			
	1997	33118	33213 Protec axle
GNVH 5 100010 3620			
	1997	33118	33213 Protec axle
GNVH 5 12010 3020			
	1997	33118	33213 Protec axle
GNVH 5 12010 3620			
	1997	33118	33213 Protec axle
GNVH 5 12010 4220			
	1999	33118	33213
GNVH 5/6 09010 4218			
	1997	33116	32310 Protec Axle
GV 2001 10510 3020			
		33116	33116 Protec axle





A







APPLICATION LISTINGS - TRAILER

A



				
		I	O	
GIGANT [SAE]				
GV 2001 12010 3020				
		33118	33116	
GVH 5 10008 3620				
	1997	33118	33213	
GVH 5 10010 3020				
	1997	33118	33213	
GVH 5 10010 3620				
	1997	33118	33213	
GVH 5 10010 4220				
	1997	33118	33213	
GVH 5 12010 3020				
	1997	33118	33213	
GVH 5 12010 3620				
	1997	33118	33213	
GVH 5 12010 4220				
	1996	33118	33213	
GZV 5 12010 4220				
	1999	33118	33213	Protec axle
SH 3 10510 3020				
		32216	32216	
SNH 3 10510 3020				
		32216	32216	
SV 2 14010 4220 [340120]				
		32220	32218	
SV 2 06706 3015				
	1990	32214	32212	
SV 2 20010 4220				
	1998		32220	
SV 2 05506 3012				
	1989	32212	32211	
SV 3 10508 3520 [340022]				
		32220	32218	
SV 3 10510 3020				
		32216	32216	
SV 3 12010 3020				
		32218	32216	

APPLICATION LISTINGS - TRAILER

			
	I	O	
GIGANT [SAE]			
SV 3 13010 3520 [340250]			
		32218	32216
5120 / S 32			
		32210	32208
5122 / S 33			
		32214	32212
5203 / S 44			
		32216	32214
5204 / S 44			
		32218	32216
5205 / S 44			
		32220	32218
5206 / S 44			
		33024	32218
5207 / S 44			
		33024	32218
7103 / S 33			
		32216	32214
7121 / S 33			
			32211
7104 / S 35			
		32218	32216
7404 / S 33			
		32216	32216
9164 / S 35			
		32218	32216
9303 / S 4420			
		32216	32214
9304 / S 4420			
		32218	32216
9404 / S 35			
		32216	32216
KÄSSBOHRER			
09-01.087			
		30218	30216
			6.5T





A







APPLICATION LISTINGS - TRAILER

A



			
	I	O	
KÄSSBOHRER			
09-01.088			
	30218	30216	6.5T
09-01.111			
	30218	32216	9T
09-01.112			
	30218	32216	9T
09-01.113			
	30218	32216	9T
09-01.114			
	30218	32216	9T
09-01.119			
	30218	32216	9T
09-01.121			
	30218	32216	9T
09-01.122			
	30218	32216	9T
09-01.030			
	32218	32216	10T
09-01.062			
	32218	32216	10T
09-01.075			
	32218	32216	10T
09-01.077			
	32218	32216	10T
09-01.089			
	32218	32216	10T
09-01.093			
	32218	32216	10T
09-01.100			
	32218	32216	10T
MERCEDES - BENZ DISCOS			
NR 5/10 DCL - 9			
	33217	32311	

APPLICATION LISTINGS - TRAILER





							
		I		O			
MONTENEGRO							
7.5 T							
		32217	32217	 061001243 / A			
8 T							
		32217	32217	 061 068/1176, 061001231			
8.5 T							
		32217	32217	 061001271			
9.5 T							
		32217	32217	 061001230/A, 0611025			
10.5 T							
		32217	32217	 061001170A			
11 T							
		HM518445/10	HM518445/10	 061001299			
11.5 T							
		HM518445/10	HM518445/10	 061001210/B, 061001295			
13 T							
		32217	32217	 0611103, 0611170			
SAF							
EBN3140 - 6							
		33211	33207				
EBN3130 - 12							
		33211	33207				
EBN4040							
		30311	30307				
EBN4530							
		33212	33209				
EBN4535							
		33212	33209				
EBN4540							
		33212	33209				
EBN4540 - 6							
		33212	33209				
EBN5535							
		33113	30309				







APPLICATION LISTINGS - TRAILER

A



			
		I	O
SAF			
ES5030			
		30312	30309
ESN4040			
		30311	30307
ESN4540			
		30312	30309
ESN5030			
		30312	30309
ESN5542			
		32213	30309
ESN6030			
		30313	30309
EZN5030			
		30312	30309
EZN6030			
		30313	30309
RBM8442			
		HM218248/10	33213
RBM8442/12			
		HM215249/10	33213
RLBM8442			
		HM218248/10	33213
RLSM11242			
		HM218248/10	33213
RLSM8442			
		HM218248/10	33213
RLSM9042			
		32924	32924
RLSM9042/20			
		32924	32924
RS5030			
		30312	30309
RSM11242			
		HM218248/10	33213
RSM6242/12 - 8			
		HM215249/10	33113

APPLICATION LISTINGS - TRAILER





			
	I	O	
SAF			
RSM6242/12 - 10			
		HM215249/10	33113
RSM6542			
		32924	32924
RSM8442			
		HM218248/10	33213
RSM8442 - 8			
		HM218248/10	33213
RSM9042			
		32924	32924
RSM9042/20			
		32924	32924
RZM11242			
		HM218248/10	33213
RZM8442 - 8			
		HM218248/10	33213
RZM13130			
		32218	32312
RZM16242			
		32221	32314
RZT16242			
		32221	32314
WESN5030			
		30312	30309
WEZN5030			
		30312	30309
WESN6030			
		30313	30309
WEZN6030			
		30313	30309
WEZN6030 - 12			
		30313	30309
WRZM11242			
		HM218248/10	33213
WRZM6242			
		HM215249/10	33113









APPLICATION LISTINGS - TRAILER

A



					
			I	O	
SAF					
WRZM6242 - 8					
			HM215249/10	33113	
WRZM8442					
			HM218248/10	33213	
WRZM8442 - 8					
			HM218248/10	33213	
WRLZM11030					
			HM218248/10	33213	
WRLZM11035 - 8					
			HM218248/10	33213	
WRLZM11035 - 10					
			HM218248/10	33213	
WRLZM8130					
			HM218248/10	33213	
WRLZM8435 - 8					
			HM218248/10	33213	
WRLZM8435 - 10					
			HM218248/10	33213	
SMB					
SMB OA / VA					
			EK50050	EK50050	9T
SCHMITZ CARGOBULL					
SKI [HSF9010]					
			33213	33118	
SKO 80/45, 80/60 [HSF9010]					
			32310A	33116	ID no. 013510-11
			32310A	33116	ID no. 013631/014945
			32310A	33116	ID no. 016951/016958
			32213	33118	ID no. 016963-64
			32213	33118	ID no. 017491-92
SKO 80/45, 80/60 [HSF9010 ECO]					
			32310A	33116	
SKO 80/45, 80/60 [HSFH9010]					
			32310A	33116	ID no. 015356-57
			32213	33118	ID no. 016977-78

APPLICATION LISTINGS - TRAILER

			
			
SCHMITZ CARGOBULL			
SKO 80/45, 80/60 [KHSF9008]			
	32310A 32213	33116 33118	ID no. 013806-07 ID no. 016979-80
SKO 80/45, 80/60 [NR5/10DCL-9DC-C/L TYP A]			
	33217	32311A	
SKO 80/45, 80/60 [NR5/10DCL-9DC-C/L TYP V]			
	33217	32311A	
SKO 80/45, 80/60 [SHSF9010]			
	32310A	33116	
SKO 80/45, 80/60 [SK500 9T U30]			
	HM218248/10	33213	
SKO 80/45, 80/60 [SKHBF9010]			
	33213	33118	
SKO 80/45, 80/60 [SKHSF9008]			
	32310A	33116	
SKO 80/45, 80/60 [SKHSF9010]			
	33213	33118	
SKO 80/45, 80/60 [SKRS9042 SK500 MRH-M/U]			
	HM218248/10	33213	
SKO 80/45, 80/60 [TZ3/2C6-10.5/MRH2]			
	33116	33020	
SKO FP 25 [HSF9010]			
	32310A 32310A 32310A 32213 32213	33116 33116 33116 33118 33118	ID no. 013510-11 ID no. 013631/014945 ID no. 016951/016958 ID no. 016963-64 ID no. 017491-92
SKO FP 25 [HSF9010 ECO]			
	32310A	33116	
SKO FP 25 [HSFH9010]			
	32310A 32213	33116 33118	ID no. 015356-57 ID no. 016977-78
SKO FP 25 [KHSF9008]			
	32310A 32213	33116 33118	ID no. 013806-07 ID no. 016979-80
SKO FP 25 [NR5/10DCL-9DC-C/L TYP A]			
	33217	32311A	
SKO FP 25 [NR5/10DCL-9DC-C/L TYP V]			
	33217	32311A	





APPLICATION LISTINGS - TRAILER

A



	I	O	
SCHMITZ CARGOBULL			
SKO FP 25 [SHSF9010]			
	32310A	33116	
SKO FP 25 [SK500 9T U30]			
	HM218248/10	33213	
SKO FP 25 [SKHBF9010]			
	33213	33118	
SKO FP 25 [SKHSF9008]			
	32310A	33116	
SKO FP 25 [SKHSF9010]			
	33213	33118	
SKO FP 25 [SKRS9042 SK500 MRH-M/U]			
	HM218248/10	33213	
SKO FP 25 [TZ3/2C6-10.5/MRH2]			
	33116	33020	
SPR/SCS [HSF9010]			
	32310A	33116	ID no. 013510-11
	32310A	33116	ID no. 013631/014945
	32310A	33116	ID no. 016951/016958
	32213	33118	ID no. 016963-64
	32213	33118	ID no. 017491-92
SPR/SCS [HSF9010 ECO]			
	32310A	33116	
SPR/SCS [HSFH9010]			
	32310A	33116	ID no. 015356-57
	32213	33118	ID no. 016977-78
SPR/SCS [KHSF9008]			
	32310A	33116	ID no. 013806-07
	32213	33118	ID no. 016979-80
SPR/SCS [NR5/10DCL-9DC-C/L TYP A]			
	33217	32311A	
SPR/SCS [NR5/10DCL-9DC-C/L TYP V]			
	33217	32311A	
SPR/SCS [SHSF9010]			
	32310A	33116	
SPR/SCS [SK500 9T U30]			
	HM218248/10	33213	
SPR/SCS [SKHBF9010]			
	33213	33118	

APPLICATION LISTINGS - TRAILER

					
			I	O	
SCHMITZ CARGOBULL					
SPR/SCS [SKHSF9008]					
			32310A	33116	
SPR/SCS [SKHSF9010]					
			33213	33118	
SPR/SCS [SKRS9042 SK500 MRH-M/U]					
			HM218248/10	33213	
SPR/SCS [TZ3/2C6-10.5/MRH2]					
			33116	33020	
TRAILOR					
L200	L300 TM	L400 TEM			
			JM718149A/10	JM515649/10	
YORK					
10 T					
			HM218248/10	33213	
13 T					
			HM218248/10	H212749/10	
15 T					
			HM220149/10	HM218248/10	





NOTES



A series of horizontal orange lines providing a ruled area for notes.



APPLICATION LISTINGS - BUS

A

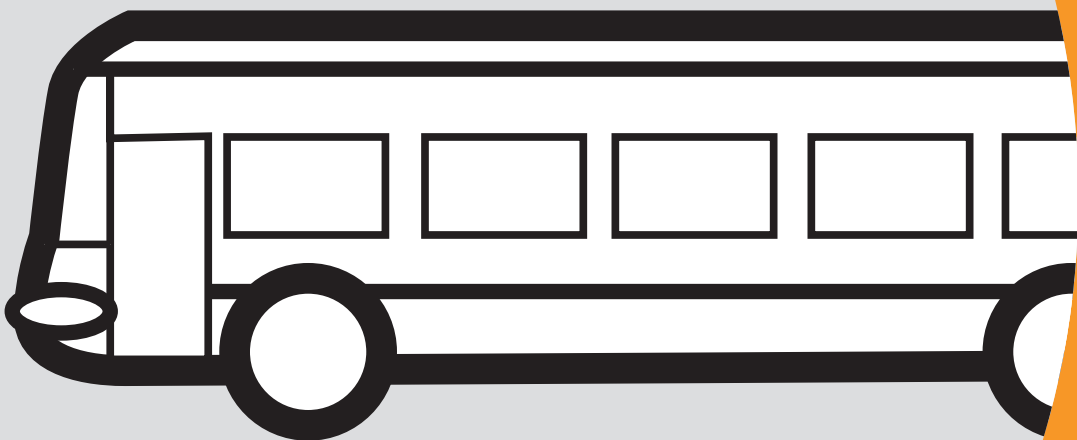





















APPLICATION LISTINGS - BUS





APPLICATION LISTINGS - BUS

					
ALEXANDER DENNIS					
TRIDENT					
		JXC25381CD-90UB6 JXC25381CD-90UB6 JXC25381CD-90UB6 JXC25381CD-90UB6			
ENVIRO 500					
		JXC25381CD-90UB6 JXC25381CD-90UB6			
BREDAMENARINIBUS					
VIVACITY M / C					
	IPA BRA 80		NP240581-90UA1		
DENNIS					
DART					
		623/612 HM801346X/10	33287/33462 3982/3920		
DELTA 1700					
	EATON 18 SERIES EATON 18 SERIES		594A/592A 575/572		
ELITE					
	EATON 18/23 SERIES EATON 18/23 SERIES EATON DS 401 EATON DS 401		594A/592A 575/572 594A/592A 575/572		
MUNICIPAL 2000/2200					
	EATON 18/23 SERIES EATON 18/23 SERIES		594A/592A 575/572		
MUNICIPAL 2400					
	EATON DS/401 BOGIE EATON DS/401 BOGIE		594A/592A 575/572		
TRIDENT					
	DANA D64 DANA D64		NP318274 NP318274		
IRISBUS					
CITYCLASS 491.10.29 / 491.12.29					
	BRA 130 / 132		NP694163-90UA4		
CITELIS 10.5 / 12					
	BRA 130 / 132		NP694163-90UA4		

A





APPLICATION LISTINGS - BUS

A

















IVECO					
315 S.8-18 / 316.8-13					
		30309 32307	32015X 32214		
315.8-13 / 315.8-17 TURBO					
		30309 32307	32015X 32214		
370 S.10-24 / 370 S.12-24					
		6386/6320 32310	XAA32219/Y32219 XAA32217/Y32217		
370 S.12-25L/30					
		6386/6320 32310	XAA32219/Y32219 XAA32217/Y32217		
370.10-24/25, 370.12-24/25					
		6386/6320 32310	32219 32217		
370.12-25L/30, 370.12-35					
		6386/6320 32310	32219 32217		
470.10-20 / 470.12-20					
		30312 32309	33021 33217		
490.18.29					
		HM212049/10 32310			
570.10-20 / 570.12-20					
		30312 32309	33021 33217		





APPLICATION LISTINGS - BUS



					
IVECO					
670.12-20					
		30312 32309	33021 33217		
2480.12					
		HM212049/10 32310	32024X 30221		
4480-18					
		HM212049/10 32310	32024X 30221		
EUROCLASS - 380.10-29					
		6386/6320 32310	XAA32219/Y32219 XAA32217/Y32217		
EUROCLASS - 380.12-29/35					
		6386/6320 32310	XAA32219/Y32219 XAA32217/Y32217		
EUROCLASS HD - 380.12-38					
		6386/6320 32310	XAA32219/Y32219 XAA32217/Y32217		
EUROTECH - 370 SE-27/29/35					
		6386/6320 32310	33213 XAA32217/Y32217		
I-EFFEUNO - 671.22-24					
		30312 32309	32024X 30221		
S-EFFEUNO - 571.10-20					
		30312 32309	32024X 30221		





APPLICATION LISTINGS - BUS

A



IVECO					
S-EFFEUNO - 571.12-20					
		30312 32309	32024X 30221		
TURBOCITY-S - 580.10-21					
		HM212049/10 32310	32024X 30221		
TURBOCITY-S - 580.12-21/22					
		HM212049/10 32310	32024X 30221		
TURBOCITY-SR - 590E.12-22					
		HM212049/10 32310	HM220149/10 HM220149/10		
TURBOCITY-U - 480.10-21/22					
		HM212049/10 32310	32024X 30221		
TURBOCITY-U - 480.12-21/22/26					
		HM212049/10 32310	32024X 30221		
TURBOCITY-UR - 490.10-22					
		HM212049/10 32310	HM220149/10 HM220149/10		
TURBOCITY-UR - 490.12-22					
		HM212049/10 32310	HM220149/10 HM220149/10		
TURBOCITY-UR - 490E.10-22					
		HM212049/10 32310	HM220149/10 HM220149/10		





APPLICATION LISTINGS - BUS

A









IVECO					
TURBOCITY-UR - 490E.12-22					
		HM212049/10 32310	HM220149/10 HM220149/10		
TURBOCITY-I - 680.12-21					
		HM212049/10 32310	32024X 30221		
TURBOCITY-I - 3480.18-29					
		HM212049/10 32310	32024X 30221		
U-EFFEUNO - 471.10-20					
		30312 32309	32024X 30221		
U-EFFEUNO - 471.12-20					
		30312 32309	32024X 30221		
KÄSSBOHRER-SETRA					
S 309 HD					
		EK50011 32309			
S 312 HD					
	ZF ZF	EK50011 32309	32022X 32021X		
S 315 HD					
	ZF ZF SCANIA SCANIA	EK50011 32309	32022X 32021X 32022X 32021X		



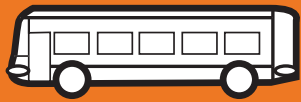

APPLICATION LISTINGS - BUS

A

													
MAN													
292 [TYPE 880]													
	V7-70 SL V7-70 SL V7-75 SL V7-75 SL H07-1080 H07-1080 H09-1180 H09-1180	EK50001 33210 EK50001 32310		33021 32019X 33021 32019X									
292/332/362 H [TYPE 882]													
	V7-70 SL V7-70 SL V7-75 SL V7-75 SL H 07-1080 H 07-1080 H 09-1180 H 09-1180	EK50001 33210 EK50001 32310		33021 32019X 33021 32019X									
EL 202 [TYPE A 12]													
	V9-65 L V9-65 L HONL-1180 HONL-1180 HONL-1180 HONL-1180	EK50001 32310		EK50021 32019X EK50021 32019X								-11/93 -11/93 12/93 - 12/93 -	
EL 202 F/262 F													
	V9-65 L V9-65 L	EK50001 32310											
EL 202/222/262													
	V9-65 L V9-65 L	EK50001 32310											
ND 202													
	V9-65 L V9-65 L	EK50001 32310											
ND 313/363 FR													
	HONP-13100			33019-90KA1									
NG 232 CNG													
	V9-65 L V9-65 L	EK50001 32310											
NG 235 F LPG													
	V9-65 L V9-65 L	EK50001 32310											
NG 252/262/272/312													
	V9-65 L V9-65 L	EK50001 32310											





APPLICATION LISTINGS - BUS

A



MAN					
NG 263/313 F					
	HONP-13100		33019-90KA1		
NG 312 BVG					
	V9-65 L	EK50001			
	V9-65 L	32310			
NG 312 F					
	V9-65 L	EK50001			
	V9-65 L	32310			
NG 312 SVB					
	V9-65 L	EK50001			
	V9-65 L	32310			
NGT 204 F					
	V9-65 L	EK50001			
	V9-65 L	32310			
NGT 204-M16					
	V9-65 L	EK50001			
	V9-65 L	32310			
NL 202/213/222					
	V9-65 L	EK50001			
	V9-65 L	32310			
NL 202 [TYPE 895] / F [TYPE 898]					
	V9-65 L	EK50001			
	V9-65 L	32310			
	HONL-1180		EK50021		
	HONL-1180		32019X		
NL 205 M11 LPG					
	V9-65 L	EK50001			
	V9-65 L	32310			
NL 223/263/313 F					
	HONP-13100		33019-90KA1		
NL 232 F CNG					
	V9-65 L	EK50001			
	V9-65 L	32310			
NL 240 F/250/262/313					
	V9-65 L	EK50001			
	V9-65 L	32310			
NL 262-BVG					
	V9-65 L	EK50001			
	V9-65 L	32310			





APPLICATION LISTINGS - BUS

A



MAN							
NL 262 R							
	V9-65 L V9-65 L	EK50001 32310					
NL 242 M12 F LPG							
	HONP-13100		33019-90KA1				
NL 243 M12							
	HONP-13100		33019-90KA1				
NL/NUE 263/313/353 F 15M							
	HONP-13100		33019-90KA1				
NM 152 MIDI BUS [TYPE A05]							
	V9-65 L V9-65 L HONM-0780 HONM-0780	EK50001 32310	XGA32021X/Y32021X 33019				
NMT 222 M10 F							
	V9-60NL HOY-0955	33209-90KA1	30218M-90KM1				
RH 352/402/422 SKD, RH 353/403 F							
	HOY-1175	33019-90KA1					
SG 242/282 H [TYPE 795]							
	HNL-70 SL HNL-70 SL V7-70 SL V7-70 SL H 07-1080 H 07-1080 H 09-1180 H 09-1180	EK50001 33210 EK50001 33210	33021 32019X 33021 32019X				
SG 242/292/322 [TYPE 793]							
	V7-70 SL V7-70 SL V7-70 SL V7-70 SL V7-75 SL V7-75 SL H 07-10/11120 H 07-10/11120 H 07-1080 H 07-1080 H 07-11120 H 07-11120 H 07-11120 H 07-11120 HOM7-1100 HOM7-1100 HOM7-1100 HOM7-1100	EK50001 32210 EK50001 33210 EK50001 32310	EK50021 32019X EK50021 32019X EK50021 32019X EK50021 32019X EK50021 32019X				 -11/93 -11/93 12/93 - 12/93 - -11/93 -11/93 12/93 - 12/93 -





APPLICATION LISTINGS - BUS

A



MAN					
SL 200					
	V7-70SL	EK50001		I	
SL 202 [TYPE 791]					
	V7-70 SL	EK50001		I	
	V7-70 SL	32210		O	
	V7-70 SL	EK50001		I	
	V7-70 SL	33210		O	
	V7-75 SL	EK50001		I	
	V7-75 SL	32310		O	
	H 07-1080		33021	I	
	H 07-1080		32019X	O	
	H 09-1180		33021	I	
	H 09-1180		32019X	O	
SUE 242 [TYPE 888]					
	V7-70 SL	EK50001		I	
	V7-70 SL	33210		O	
	V7-75 SL	EK50001		I	
	V7-75 SL	32310		O	
	H 07-1080		33021	I	
	H 07-1080		32019X	O	
	H 09-1180		33021	I	
	H 09-1180		32019X	O	
SUE 240/280 [TYPE 789]					
	V7-70 SL	EK50001		I	
	V7-70 SL	33210		O	
	H 07-1080		33021	I	
	H 07-1080		32019X	O	
MERCEDES-BENZ					
508 I					
	VL 2/6-31	33111		I	
	VL 2/6-31	32306		O	
	HL 2/3-57		47490/47420	I	
	HL 2/3-57		33111	O	
	HL 4/01 D-10/47:9		33020	I	
	HL 4/01 D-10/47:9		33117	O	
709					
	VL 1/9 C-2.3	33109		I	
	VL 1/9 C-2.3	33205		O	
	VL 2/13 C-2.9	33111		I	
	VL 2/13 C-2.9	32306		O	
710					
	VL 1/9 C-2.3	33109		I	
	VL 1/9 C-2.3	33205		O	
	VL 2/13 C-2.9	33111		I	
	VL 2/13 C-2.9	32306		O	
	HL 2/17-5.9/40:11		33011	I	
	HL 2/17-5.9/43:10		33011	O	









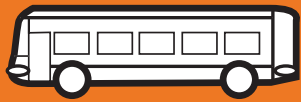

APPLICATION LISTINGS - BUS

A



      	
MERCEDES-BENZ	
712	
VL 1/9 C-2.3 VL 1/9 C-2.3 VL 2/13 C-2.9 VL 2/13 C-2.9	33109 33205 33111 32306
712 E	
VL 2/13 C-2.9 VL 2/13 C-2.9 HL 2/17-5.9/43:10	33111 32306 33011
1114	
VL 2/13 C-2.9 VL 2/13 C-2.9 HL2/15-5.9/40:11 HL 2/17-5.9/43:10 HL 4/35 D-78	33111 32306 33011 33011 580/572
1114 K	
VL 3/11 D-44 VL 3/11 D-44 HL 4/35 D-78	33213 33208 580/572
1114 L	
VL 3/11 D-44 VL 3/11 D-44 HL 4/30 DS-64 HL 4/35 D-78 HL 4/35 D-92	33213 33208 32016X 580/572 33019
1114 S	
VL 3/11 D-44 VL 3/11 D-44	33213 33208
1117	
VL 3/11 D-44 VL 3/11 D-44 HL 4/35 D-78	33213 33208 580/572
1117 K	
VL 3/11 D-44 VL 3/11 D-44 HL 4/35 D-78	33213 33208 580/572
1117 L	
VL 3/11 D-44 VL 3/11 D-44 VL 3/12 D-53 VL 3/12 D-53 HL 4/35 D-78 HL 4/35 D-92 HL 4/05 D-9.2 HL 4/05 D-9.2	33213 33208 33213 33208 580/572 33019 33019 33215









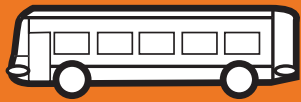

APPLICATION LISTINGS - BUS

A













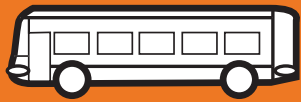



						
MERCEDES-BENZ						
1117 L0						
	VL 3/11 D-44 VL 3/11 D-44	33213 33208			I O	
1117 LS						
	VL 3/11 D-44 VL 3/11 D-44 HL 4/35 D-78 HL 4/35 D-92	33213 33208		580/572 33019	I O I I	
1117 S						
	VL 3/11 D-44 VL 3/11 D-44 HL 4/35 D-78 HL 4/35 D-92	33213 33208		580/572 33019	I O I I	
1120						
	VL 3/11 D-44 VL 3/11 D-44 HL 4/35 D-78	33213 33208		580/572	I O I	
1120 L						
	VL 3/11 D-44 VL 3/11 D-44 HL 4/35 D-78 HL 4/35 D-92 HL 4/05 D-9.2 HL 4/05 D-9.2	33213 33208		580/572 33019 33019 33215	I O I I I O	
1120 LS						
	VL 3/11 D-44 VL 3/11 D-44 HL 4/05 D-9.2 HL 4/05 D-9.2 HL 4/35 D-78 HL 4/35 D-92	33213 33208		33019 33215 580/572 33019	I O I O I I	
1120 S						
	VL 3/11 D-44 VL 3/11 D-44 HL 4/35 D-78 HL 4/35 D-92	33213 33208		580/572 33019	I O I I	
1121 L						
	VL 2/11 D-3.8 VL 3/11 D-44 VL 3/11 D-44 HL 4/29 D-92 HL 4/35 D-78 HL 4/35 D-92	33211 33213 33208		33117 580/572 33019	I I O I I I	
1314						
	VL 3/11 D-44 VL 3/11 D-44	33213 33208			I O	





APPLICATION LISTINGS - BUS

A

						
MERCEDES-BENZ						
1314 ...						
	VL 3/12 D-53 VL 3/12 D-53 HL 4/05 D-9.2 HL 4/05 D-9.2 HL 4/29 D-92 HL 4/35 D-92	33213 33208		33019 33215 33117 33019		
1314 K						
	VL 3/11 D-44 VL 3/11 D-44 VL 3/12 D-53 VL 3/12 D-53 HL 4/05 D-9.2 HL 4/05 D-9.2 HL 4/29 D-92 HL 4/35 D-92	33213 33208 33213 33208		33019 33215 33117 33019		
1314 K0						
	VL 3/12 D-53 VL 3/12 D-53 HL 4/29 D-92 HL 4/35 D-92	33213 33208		33117 33019		
1314 L						
	VL 3/11 D-44 VL 3/11 D-44 VL 3/12 D-53 VL 3/12 D-53 HL 4/05 D-9.2 HL 4/05 D-9.2 HL 4/29 D-92 HL 4/35 D-92	33213 33208 33213 33208		33019 33215 33117 33019		
1314 LK0						
	VL 3/12 D-53 VL 3/12 D-53 HL 4/29 D-92 HL 4/35 D-92	33213 33208		33117 33019		
1317						
	VL 3/11 D-44 VL 3/11 D-44 VL 3/12 D-53 VL 3/12 D-53 HL 4/05 D-9.2 HL 4/05 D-9.2 HL 4/29 D-92 HL 4/35 D-92	33213 33208 33213 33208		33019 33215 33117 33019		
1317 K						
	VL 3/11 D-44 VL 3/11 D-44 VL 3/12 D-53 VL 3/12 D-53	33213 33208 33213 33208				





APPLICATION LISTINGS - BUS

A



MERCEDES-BENZ					
1317 K ...					
	HL 4/05 D-9.2 HL 4/05 D-9.2 HL 4/29 D-92 HL 4/35 D-92		33019 33215 33117 33019		
1317 K0					
	VL 3/12 D-53 VL 3/12 D-53 HL 4/29 D-92 HL 4/35 D-92	33213 33208	33117 33019		
1317 S					
	VL 3/11 D-44 VL 3/11 D-44 VL 3/12 D-53 VL 3/12 D-53 HL 4/05 D-9.2 HL 4/05 D-9.2 HL 4/29 D-92 HL 4/35 D-92	33213 33208 33213 33208	33019 33215 33117 33019		
1320					
	VL 3/11 D-44 VL 3/11 D-44 VL 3/12 D-53 VL 3/12 D-53 HL 4/05 D-9.2 HL 4/05 D-9.2	33213 33208 33213 33208	33019 33215		
1320 L					
	VL 3/11 D-44 VL 3/11 D-44 VL 3/12 D-53 VL 3/12 D-53 VL 3/13 D-56 VL 3/13 D-56 VL 3/13 D-56 VL 3/13 D-56 HL 4/05 D-9.2 HL 4/05 D-9.2	33213 33208 33213 33208 33214 33209 33214 33210	33019 33215		- 1358880 exc. 1355905 - 1358880 exc. 1355905 1358881 - 1355905 1358881 - 1355905
1320 LS					
	VL 3/11 D-44 VL 3/11 D-44 VL 3/12 D-53 VL 3/12 D-53 HL 4/05 D-9.2 HL 4/05 D-9.2	33213 33208 33213 33208	33019 33215		
1320 S					
	VL 3/11 D-44 VL 3/11 D-44 VL 3/12 D-53 VL 3/12 D-53	33213 33208 33213 33208			





APPLICATION LISTINGS - BUS











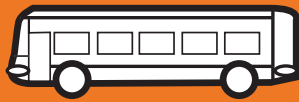



A

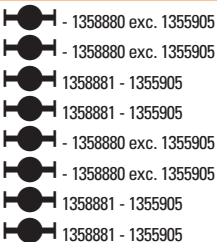

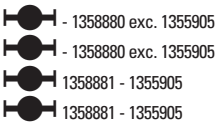
MERCEDES-BENZ					
1320 S ...					
	HL 4/05 D-9.2		33019		
	HL 4/05 D-9.2		33215		
1514 L					
	VL 3/13 D-56	33214	33020		- 1358880 exc. 1355905
	VL 3/13 D-56	33209			- 1358880 exc. 1355905
	VL 3/13 D-56	33214			1358881 - 1355905
	VL 3/13 D-56	33210			1358881 - 1355905
	HL 4/08 D-106				33117
	HL 4/08 D-106				33019
	HL 4/32 D-106				33215
	HL 4/32 D-106				33020
	HL 4/35 D-106				33215
	HL 4/35 D-106				33215
1517					
	VL 3/13 D-56	33214	33020		- 1358880 exc. 1355905
	VL 3/13 D-56	33209			- 1358880 exc. 1355905
	VL 3/13 D-56	33214			1358881 - 1355905
	VL 3/13 D-56	33210			1358881 - 1355905
	HL 4/08 D-106				33117
	HL 4/08 D-106				33019
	HL 4/32 D-106				33215
	HL 4/32 D-106				33020
	HL 4/35 D-106				33215
	HL 4/35 D-106				33215
1520					
	VL 3/13 D-56	33214	33020		- 1358880 exc. 1355905
	VL 3/13 D-56	33209			- 1358880 exc. 1355905
	VL 3/13 D-56	33214			1358881 - 1355905
	VL 3/13 D-56	33210			1358881 - 1355905
	VL 3/15 D-65	33214			- 1358880 exc. 1355905
	VL 3/15 D-65	33209			- 1358880 exc. 1355905
	VL 3/15 D-65	33214			1358881 - 1355905
	VL 3/15 D-65	33210			1358881 - 1355905
	HL 4/08 D-106				33117
	HL 4/08 D-106				
1520 L					
	VL 3/13 D-56	33214	33020		- 1358880 exc. 1355905
	VL 3/13 D-56	33209			- 1358880 exc. 1355905
	VL 3/13 D-56	33214			1358881 - 1355905
	VL 3/13 D-56	33210			1358881 - 1355905
	HL 4/08 D-106				33117
	HL 4/08 D-106				
1524					
	VL 3/13 D-56	33214	33020		- 1358880 exc. 1355905
	VL 3/13 D-56	33209			- 1358880 exc. 1355905
	VL 3/13 D-56	33214			1358881 - 1355905
	VL 3/13 D-56	33210			1358881 - 1355905
	HL 4/08 D-106				33117
	HL 4/08 D-106				



APPLICATION LISTINGS - BUS

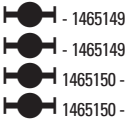

















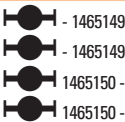

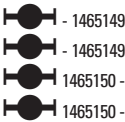
		 			
MERCEDES-BENZ					
1720					
	VL 3/13 D-56 VL 3/13 D-56 VL 3/13 D-56 VL 3/13 D-56 VL 3/15 D-65 VL 3/15 D-65 VL 3/15 D-65 VL 3/15 D-65 VL 3/15 D-65 HL 4/08 D-106 HL 4/08 D-106	33214 33209 33214 33210 33214 33209 33214 33210	33020 33117		 - 1358880 exc. 1355905 - 1358880 exc. 1355905 1358881 - 1355905 1358881 - 1355905 - 1358880 exc. 1355905 - 1358880 exc. 1355905 1358881 - 1355905 1358881 - 1355905
2020 L					
	VL 3/11 D-44 VL 3/11 D-44 VL 3/12 D-53 VL 3/12 D-53 VL 3/13 D-56 VL 3/13 D-56 VL 3/13 D-56 VL 3/13 D-56 HL 4/08 D-106 HL 4/08 D-106 HL 4/05 D-9.2 HL 4/05 D-9.2	33213 33208 33213 33208 33214 33209 33214 33210	33020 33117 33019 33215		 - 1358880 exc. 1355905 - 1358880 exc. 1355905 1358881 - 1355905 1358881 - 1355905
BH 3 - N					
	VO 3/10 DL-6 VO 3/10 DL-6 HO 4/01 DL-10 HO 4/01 DL-10	33214 33210	33020 33117		
BH 4					
	HO 4/01 DL-10 HO 4/01 DL-10		33020 33117		
BH 4 - 23					
	VO 3/10 DL-6 VO 3/10 DL-6 HO 4/01 DL-10 HO 4/01 DL-10	33214 33210	33020 33117		
BH 4 - N					
	HO 4/01 DL-10 HO 4/01 DL-10		33020 33117		
BGT - 25					
	VO 4/18 DL-7 VO 4/18 DL-7 VO 4/18 DL-7 VO 4/18 DL-7 HO 7/01 DL-10 HO 7/01 DL-10	EK50011 33210 EK50011 32310	33021 32019X	  - 1465149 - 1465149 1465150 - 1465150 -	

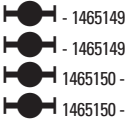

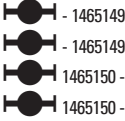

APPLICATION LISTINGS - BUS

A

 		  			
MERCEDES-BENZ					
BGT - N 2					
	VO 4/33 DL-6.6 VO 4/33 DL-6.6 VO 4/33 DL-6.6 VO 4/33 DL-6.6 HO 7/01 DL-11.5 HO 7/01 DL-11.5	EK50011 33210 EK50011 32310	33021 32019X		 <ul style="list-style-type: none"> - 1465149 - 1465149 1465150 - 1465150 -
BGU - 25					
	VO 4/18 DL-7 VO 4/18 DL-7 VO 4/18 DL-7 VO 4/18 DL-7 HO 7/01 DL-10 HO 7/01 DL-10	EK50011 33210 EK50011 32310	33021 32019X		 <ul style="list-style-type: none"> - 1465149 - 1465149 1465150 - 1465150 -
BT - 25					
	VO 4/18 DL-7 VO 4/18 DL-7 VO 4/18 DL-7 VO 4/18 DL-7 HO 7/01 DL-10 HO 7/01 DL-10	EK50011 33210 EK50011 32310 33021 32019X			 <ul style="list-style-type: none"> - 1465149 - 1465149 1465150 - 1465150 -
BU 5 - 25					
	VO 4/18 DL-7 VO 4/18 DL-7 VO 4/18 DL-7 VO 4/18 DL-7 HO 7/01 DL-10 HO 7/01 DL-10	EK50011 33210	EK50011 32310 33021 32019X		 <ul style="list-style-type: none"> - 1465149 - 1465149 1465150 - 1465150 -
CBC FAHRGESTELL 2 - AC					
	VO 4/39 CL-75 VO 4/39 CL-75 HO 6/6 DCL [S]-13 HO 6/6 DCL [S]-13 HO 6/DCL-13	EK50011 32310	33022 33022 33022		SA 40430423,SA 50435107 SA 40430423,SA 50435107  <ul style="list-style-type: none"> - M053279,N287999 M053280,N288000 -
CITARO [O 530]					
	VO 4/39 CL-7.5 VO 4/39 CL-75 VO 4/39 CL-75 HO 6/6 DCL [S]-13 HO 6/6 DCL [S]-13 ZF-RL-75/EC	EK50011 EK50011 32310	33022 33022 32312		 <ul style="list-style-type: none"> - M053279,N287999 M053280,N288000 -
CITARO [O 530] G					
	VO 4/36CL-7 VO 4/36CL-7 VO 4/39 CL-75 VO 4/39 CL-75	EK50011 32310 EK50011 32310			





APPLICATION LISTINGS - BUS

A



MERCEDES-BENZ					
CITARO [0 530] GNG					
	VO 4/36CL-7 VO 4/36CL-7 VO 4/39 CL-75 VO 4/39 CL-75	EK50011 32310 EK50011 32310			
CITARO [0 530] L					
	VO 4/36 CL-7 VO 4/36 CL-7 VO 4/39 CL-75 VO 4/39 CL-75 ZF-RL-75/A	EK50011 32310 EK50011 32310	32312		
CITARO [0 530] N					
	VO 4/36 CL-7 VO 4/36 CL-7 VO 4/39 CL-75 VO 4/39 CL-75	EK50011 32310 EK50011 32310			
CITARO [0 530] N3					
	VO 4/36 CL-7 VO 4/36 CL-7 VO 4/39 CL-75 VO 4/39 CL-75	EK50011 32310 EK50011 32310			
CITARO [0 530] NG					
	VO 4/36 CL-7 VO 4/36 CL-7 VO 4/39 CL-75 VO 4/39 CL-75	EK50011 32310 EK50011 32310			
CONNECTO [O 345]					
	VO 4/34 DL-7 VO 4/34 DL-7 VO 4/34 DL-7 HO 7/10 D-115 HO 7/10 D-115 HO 7/10 DL-11.5 HO 7/10 DL-11.5 NR 7/5 DL-10 NR 7/5 DL-10 NR 7/5 DL-10 NR 7/5 DL-10	EK50011 EK50011 32310	33021 32019X 33021 32019X 33021 32019X 33021 32019X		570957 - 570957 -
CONNECTO [O 345] C, H, M, UE					
	VO 4/34 DL-7 VO 4/34 DL-7	EK50011 32310			
INTEGRO	INTOURO				
	HO 6/4 DCL [S]-13		33022-9X026		











APPLICATION LISTINGS - BUS

A











      	
MERCEDES-BENZ	
O 301	
V0 3/9 DL-5 V0 3/9 DL-5 VL 1/3-2.1 VL 1/3-2.1 VL 1/3-2.1 VL 1/3-2.1 VL 1/4-1.6 VL 1/4-1.6 VL 1/4-1.6 VL 1/4-1.6 VL 1/4-1.6 VL 1/4-1.6 VL 1/5-2.3 VL 1/5-2.3 VL 1/6-2.3 VL 1/6-2.3 VL 1/7-2.6 VL 1/7-2.6 VL 2/11 D-3.8 VL 2/11 D-3.8 HL 1/2-3.3 HL 1/2-3.3 HL 1/3-4.5 HL 1/3-4.5 HL 2/5-4.5 HL 2/5-4.5 HL 2/9-4.7 HL 2/9-4.7	33213 33208 2789/2720 1380/1328 33109 33205 32208 32304 2789/2720 1380/1328 33109 33205 33109 33205 33109 33205 33109 33205 33211 EK50029 32211 32210 3984/3920 33895/33822 3984/3920 33895/33822 3984/3920 33895/33822
O 303	
V0 3/10 DL-6 V0 3/10 DL-6 V0 3/10 DL-6 V0 3/10 DL-6 V0 3/10 DL-6 V0 3/9 DL-5 V0 3/9 DL-5 V0 3/9 DL-5 V0 4/13 DL-7 V0 4/13 DL-7 V0 4/13 DL-7 V0 4/13 DL-7 V0 4/13 DL-7 V0 4/13 DL-7 V0 4/13 DL-7 VL 1/3-2.1 VL 1/3-2.1 VL 1/3-2.1 VL 1/3-2.1 VL 1/4-1.6 VL 1/4-1.6 VL 1/4-1.6	33214 33209 33214 33210 33209-90KA1 33213 33208 33208-90KA1 EK50011 33210 EK50011 32310 EK50011 EK50011 2789/2720 1380/1328 33109 33205 32208 32304 2789/2720

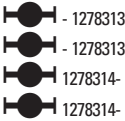

APPLICATION LISTINGS - BUS

A







							
MERCEDES-BENZ							
O 303 ...							
	VL 1/4-1.6	1380/1328			Ch.17769-Ch.17814 Diesel, Ch.1289-Ch.4706 Petrol Ch.17815- Diesel, Ch.4707- Petrol Ch.17815- Diesel, Ch.4707- Petrol		
	VL 1/4-1.6	33109					
	VL 1/4-1.6	33205					
	VL 1/5-2.3	33109					
	VL 1/5-2.3	33205					
	VL 1/6-2.3	33109					
	VL 1/6-2.3	33205					
	VL 1/7-2.6	33109					
	VL 1/7-2.6	33205					
	VL 2/11 D-3.8	33211					
	VL 2/11 D-3.8	EK50029					
	HO 4/01 DL-10		33020				
	HO 4/01 DL-10		33117				
	HO 4/10 DL-10		33019				
	HO 4/10 DL-10		33215				
	HO 4/10 DL-10		33019-90KA1				
	HO 4/10 L-10		33019				
	HO 4/10 L-10		33215				
	HO 4/18 DL-7.7		32216				
	HO 4/18 DL-7.7		39586/39528				
	HO 4/18 DL-7.7		32216-90KA1				
	HO 4/18 L-7.7		32216				
	HO 4/18 L-7.7		39586/39528				
	HO 5/8 DL-10		33019				
	HO 5/8 DL-10		33215				
	HO 5/8 DL-10		33019-90KA1				
	HO 5/8 L-10		33019				
	HO 5/8 L-10		33215				
	HL 1/2-3.3		32211				
	HL 1/2-3.3		32210				
	HL 1/3-4.5		3984/3920				
	HL 1/3-4.5		33895/33822				
	HL 2/5-4.5		3984/3920				
	HL 2/5-4.5		33895/33822				
	HL 2/9-4.7		3984/3920				
	HL 2/9-4.7		33895/33822				
O 305/307							
	VO 4/11 DL-7	EK50011					 - 1278313 - 1278313 1278314- 1278314-
	VO 4/11 DL-7	33210					
	VO 4/11 DL-7	EK50011					
	VO 4/11 DL-7	32310					
	HO 7/8 DL-10		33021				
	HO 7/8 DL-10		32019X				
	NR 7/4 DL-10		33021				
	NR 7/4 DL-10		32019X				
	NR 7/5 DL-10		33021				
	NR 7/5 DL-10		32019X				
O 309/309 D							
	VO 3/9 DL-5	33213			-Ch.48630		
	VO 3/9 DL-5	33208					
	VL 1/3-2.1	2789/2720					



APPLICATION LISTINGS - BUS

A



     	
MERCEDES-BENZ	
O 309/309 D ...	
VL 1/3-2.1 VL 1/3-2.1 VL 1/3-2.1 VL 1/4-1.6 VL 1/4-1.6 VL 1/4-1.6 VL 1/4-1.6 VL 1/4-1.6 VL 1/4-1.6 VL 1/5-2.3 VL 1/5-2.3 VL 1/6-2.3 VL 1/6-2.3 VL 1/7-2.6 VL 1/7-2.6 VL 2/11 D-3.8 VL 2/11 D-3.8 HL 1/2-3.3 HL 1/2-3.3 HL 1/3-4.5 HL 1/3-4.5 HL 2/5-4.5 HL 2/5-4.5 HL 2/9-4.7 HL 2/9-4.7	1380/1328 33109 33205 32208 32304 2789/2720 1380/1328 33109 33205 33109 33205 33109 33205 33109 33205 33211 EK50029 32211 32210 3984/3920 33895/33822 3984/3920 33895/33822 3984/3920 33895/33822
O 402	
VL 2/11 D-3.8 VL 2/11 D-3.8 VO 4/18 DL-7 VO 4/18 DL-7 VO 4/22 DLE-6.6 VO 4/22 DLE-6.6	33211 EK50029 EK50011 32310 EK50011 32310
O 404	
VO 4/21 CLE-6.6 VO 4/21 CLE-6.6 VO 4/21 CLE-6.6 VO 4/21 CLE-6.6 VO 4/22 DLE-6.6 VO 4/22 DLE-6.6 VO 4/22 DLE-6.6 VO 4/22 DLE-6.6 VO 4/22 DLE-6.6 VO 4/22 DLE-6.6 VO 4/22 DLE-6.6 VO 4/22 DLE-6.6 VO 4/35 CLE-7.5 VO 4/35 CLE-7.5 VO 4/35 CLE-7.5 VO 4/35 CLE-7.5 VL 2/11 D-3.8 VL 2/11 D-3.8 HO 4/01 DL-11.5	EK50031 33310 EK50031 32310 EK50011 33210 EK50011 32310 EK50011 32310 EK50011 32310 EK50031 33310 EK50031 32310 33211 EK50029 33020





APPLICATION LISTINGS - BUS

A



MERCEDES-BENZ					
O 404 ...					
	HO 4/01 DL-11.5 HO 4/02 CL-11.5 HO 4/02 CL-11.5 HO 4/04 DCL-11.5 HO 4/04 DCL-11.5		33117 33020 33117 33020 33117		
O 405					
	VO 4/18 DL-7 VO 4/18 DL-7 VO 4/18 DL-7 VO 4/18 DL-7 VO 4/18 DL-7 VO 4/22 DLE-6.6 VO 4/22 DLE-6.6 VO 4/33 DL-6.6 VO 4/33 DL-6.6 VO 4/33 DL-6.6 VO 4/33 DL-6.6 VO 4/33 DL-6.6 VO 4/33 DL-6.6 VO 4/34 DL-7 VO 4/34 DL-7 VO 4/34 DL-7 VO 4/34 DL-7 VO 4/34 DL-7 VL 2/11 D-3.8 VL 2/11 D-3.8 HO 7/02 DLM-10 HO 7/02 DLM-10 HO 7/09 DL-10 HO 7/09 DL-10 HO 7/10 DL-11.5 HO 7/10 DL-11.5 NR 7/4 DL-10 NR 7/4 DL-10 NR 7/5 DL-10 NR 7/5 DL-10	EK50011 33210 EK50011 33210 EK50011 EK50011 32310 EK50011 33210 EK50011 33210 EK50011 EK50011 EK50011 33210 EK50011 33210 EK50011 33210 EK50011 33211 EK50029	33021 32019X 33021 32019X 33021 32019X 33021 32019X 33021 32019X		- 1278313 - 1278313 1278314- 1278314- - 1278313 - 1278313 1278314- 1278314- - 1278313 1278314 - - 1278313 - 1278313 1278314- 1278314- 1278314 -
O 407/408					
	VO 4/18 DL-7 VO 4/18 DL-7 VO 4/18 DL-7 VO 4/18 DL-7 VO 4/22 DLE-6.6 VO 4/22 DLE-6.6 VL 2/11 D-3.8 VL 2/11 D-3.8 VL 4/18 DL-7 VL 4/18 DL-7 HO 7/02 DLM-10 HO 7/02 DLM-10 HO 7/09 DL-10 HO 7/09 DL-10 HO 7/10 DL-11.5 HO 7/10 DL-11.5	EK50011 33210 EK50011 32310 EK50011 32310 33211 EK50029 EK50011 EK50011	33021 32019X 33021 32019X 33021 32019X		- 1278313 - 1278313 1278314- 1278314- - 1278313 - 1278314 -





APPLICATION LISTINGS - BUS

A



MERCEDES-BENZ					
O 500 R					
	VO 4/39 CL-7.5 VO 4/13 DL-7 VO 4/40 DCL-7.1	EK50011 EK50011 EK50011			
O 608 D/609 D/611 D					
	VL 1/10 C-2.5 VL 1/10 C-2.5 VL 1/9 C-2.3 VL 1/9 C-2.3 HL 1/8-4.7 HL 1/8-4.7 HL 1/9-5.6 HL 1/9-5.6 HL 2.5-4.5 HL 2.5-4.5 HL 2/15-5.8 HL 2/15-5.8	33109 33205 33109 33205	32014X 32011X 33015 33011 3984/3920 33895/33822 33015 33011		
O 614 D					
	VL 1/10 C-2.5 VL 1/10 C-2.5 VL 1/9 C-2.3 VL 1/9 C-2.3 HL 1/8-4.7 HL 1/8-4.7 HL 1/9-5.6 HL 1/9-5.6 HL 2.5-4.5 HL 2.5-4.5 HL 2/15-5.8 HL 2/15-5.8	33109 33205 33109 33205	32014X 32011X 33015 33011 3984/3920 33895/33822 33015 33011		
O 814/817					
	VL 2/10 D-3.5 VL 2/10 D-3.5 VL 2/9 D-3.1 VL 2/9 D-3.1 HL 2/11 D-5.8 HL 2/11 D-5.8 HL 2/13 D-6.4 HL 2/13 D-6.4 HL 4/30 D-6.4 HL 4/30 D-6.4 HL 4/30 DS-6.4 HL 4/30 DS-6.4 HL 4/35 D-6.4 HL 4/35 D-6.4	33211 32306 33111 32306	33015 33011 JM714249/10 33112 32016X 33113 32016X 33113 32016X 33113		
O 1114/1117/1120					
	VL 2/11 D-3.8 VL 2/11 D-3.8 VL 3/11 D-44 VL 3/11 D-44 HL 4/28 D-7.8	33211 EK50029 33213 33208	580/572		





APPLICATION LISTINGS - BUS



MERCEDES-BENZ					
O 1114/1117/1120 ...					
	HL 4/28 D-7.8 HL 4/29 D-9.2 HL 4/29 D-9.2 HL 4/35 D-78 HL 4/35 D-92 HL 4/35 D-92		39586/39528 33117 EK50037 580/572 33019 EK50037		
O 1317					
	HL 5/1 Z-10 HL 5/1 Z-10		598/592A 32215		
O 1417					
	HL 4/04 D-12 HL 4/04 D-12		33020 33117		
O 1617/1625/1628					
	VL 4/2 D-7 VL 4/2 D-7 VO 4/18 DL-7 VO 4/18 DL-7	30314 32310 EK50011 32310			
OH 1622/1625/1627					
	VO 4/10 D-7 VO 4/10 D-7 VO 4/18 DL-7 VO 4/18 DL-7 VO 4/18 DL-7 VO 4/18 DL-7 HL 4/01 DL-10 HL 4/01 DL-10	EK50011 32310 EK50011 32310 EK50011 32310	33020 33117		1278314- 1278314- - 1278313 - 1278313 1278314- 1278314-
OH 1628/1634					
	VO 4/10 D-7 VO 4/10 D-7 VO 4/18 DL-7 VO 4/18 DL-7 VO 4/18 DL-7 VO 4/18 DL-7 HL 4/01 DL-10 HL 4/01 DL-10	EK50011 32310 EK50011 32310 EK50011 32310	33020 33117		1278314- 1278314- - 1278313 - 1278313 1278314- 1278314-
TOURISMO MBT [O 340]					
	VO 4/13 DL-7 VO 4/13 DL-7 VO 4/13 DL-7 VO 4/13 DL-7 HO 6/4 DCL[S]-13 HO 4/01 DL-10 HO 4/01 DL-10	EK50011 33210 EK50011 32310	33022-9X026 33020 33117		- 1465149 - 1465149 1465150 - 1465150 -





APPLICATION LISTINGS - BUS

A



















MERCEDES-BENZ					
TOURO					
	ZF-RL-75-E HO 6/6 DCL [S]-13 HO 6/6 DCL [S]-13 HO 6/DCL-13	32312	33022 33022 33022		- M053279,N287999 M053280,N288000 -
TRAVEGO [O 580]					
	HO 6/1 DCL [S]-13 HO 6/1 DCL [S]-13 HO 6/4 DCL [S]-13 HO 6/4 DCL [S]-13 HO 8/1 DCL [S]-13 HO 8/1 DCL [S]-13 ZF-RL-75-E HO 6/1 DCL [S]-13 HO 6/4 DCL [S]-13 HO 8/1 DCL [S]-13 ZF-RL 75/A	33022 33022 33022 33022 33022 33022 32312	33022-9X026 33022-9X026 33022-9X026 32312		- M053279,N287999 M053280,N288000 - - M053279,N287999 M053280,N288000 - - M053279,N287999 M053280,N288000 -
VU 4 - 23					
	V0 3/10 DL-6 V0 3/10 DL-6 HO 7/01 DLS-10 HO 7/01 DLS-10	33214 33210	33021 32019X		
RENAULT RVI					
AGORA CITYBUS					
			JF9549/10 33216		
ER 100 - 2					
	R1 6A R1 6A	33213 33209	52375/52618 683/672		
FRH					
	R1 65 R R1 65 R PX 1141 PX 1141	33214 32309B	JF9549/10 33216		12/92 - 12/92 - 12/92 - 12/92 -
FRI					
	R1 65 R R1 65 R R1 65 R R1 65 R PX 1141 PX 1141 PX 1141 PX 1141	33214 32309 33214 32309B	JF9549/10 33216 JF9549/10 33216		- 12/85 - 12/85 01/86 - 01/86 - - 12/83 - 12/83 01/84 - 01/84 -



APPLICATION LISTINGS - BUS

A

		 			
RENAULT RVI					
G 45 / S					
E6A E6A E6A P 1321 B P 1321 B	33214 32309 33214		52375/52618 683/672		- 14/03/84 - 14/03/84 15/03/84 -
G 105 / S					
E6A E6A E6A P 1321 B P 1321 B	33214 32309 33214		52375/52618 683/672		- 14/03/84 - 14/03/84 15/03/84 -
GX 187					
R1 6A R1 6A PX 1021/ PX SAR 1021 PX 1021/ PX SAR 1021	33213 33209		52375/52618 683/672		
GX 317					
			JF9549/10 33216		
MEGABUS					
R1 6A R1 6A PX 1021/ PX SAR 1021 PX 1021/ PX SAR 1021	33213 33209		52375/52618 683/672		
PER 180					
PX 1021/ PX SAR 1021 PX 1021/ PX SAR 1021			52375/52618 683/672		
PG 60 / S					
E6A E6A E6A P 1321 B P 1321 B	32309 33214 33214		52375/52618 683/672		- 14/03/84 - 14/03/84 15/03/84 -
PGC 191 / 231					
E5A E5A P 1021 J P 1021 J	33213 33209		52375/52618 683/672		
PR 8 C					
E5A E5A E5A E5A E5A E5A	33213 33209 33213 33209 33213 33210				- 05/91 - 05/91 06/91 - 03/93 06/91 - 03/93 04/93 - 04/93 -



APPLICATION LISTINGS - BUS

A



RENAULT RVI					
PR 8 C ...					
	P 1140 P 1140		32019X 33117		
PR 10 / 12					
	E5A E5A PX 821 G PX 821 G	33213 33209	594/593X 594/593X		
PR 14					
	E5A E5A P 1021 / PX 1021 P 1021 / PX 1021	33213 33209	52375/52618 683/672		
PR 100					
	R1 6A R1 6A R1 6A R1 6A PX 1021/ PX SAR 1021 PX 1021/ PX SAR 1021	JH211749/10 33109 JH211749/10 33209	52375/52618 683/672		- 08/84 MOT. 62030 - N1539 - 08/84 MOT. 62030 - N1539 - 08/84 MOT. 62030 - N1540 - 08/84 MOT. 62030 - N1540 - 08/84 MOT. 62030 - 08/84 MOT. 62030
PR 100 - 2					
		33213 33209	52375/52618 683/672		
PR 100 - 3 / 112 / 118					
	PU 04 / PS 08 PU 04 / PS 08		JF9549/10 33216		
PR 180					
	R1 6A R1 6A R1 6A R1 6A PX 1021/ PX SAR 1021 PX 1021/ PX SAR 1021	33213 33209 JH211749/10 33209	52375/52618 683/672		- 08/84 MOT. 62030 - 08/84 MOT. 62030
TRACER					
			JF9549/10 33117 JF9549/10 33216		
SCANIA					
B/BF 86					
	AM 55 AM 55 AM 55	32308 32311 32308			⊗ - Ch.1850412 ⊗ Ch.1850413 - ⊗ Ch.1850413 -





APPLICATION LISTINGS - BUS

A



SCANIA					
B/BF 86 ...					
	AM 60 AM 60 R 640 R 640 R 640 R 640 R 653 R 653	32312 32309	32216 32215 32216 32215 32218 32218		 - Ch.1850412 - Ch.1850412 Ch.1850413 - Ch.1850413 - - Ch.1850412 - Ch.1850412
B 111					
	R 640 R 640 R 640 R 640 R 640 R 640 R 653 R 653 R 653 R 653 R 653 R 653	32308	32216 32215 32216 33215 32216 33215 32218 32218 32218 32218 HM218248Z/10 HM218248Z/10		- Ch.1871409 - Ch.1871409 - Ch.1871409 Ch.1871410 - Ch.1871595 Ch.1871410 - Ch.1871595 Ch.1871596 - Ch.1871596 - - Ch.1871409 - Ch.1871409 - Ch.1871409 - Ch.1871409 Ch.1871410 - Ch.1871410 -
BF 111/CKD					
	R 640 R 640 R 640 R 640 R 640 R 640 R 653 R 653 R 653 R 653 R 653 R 653	32312 32309	32216 32215 32216 33215 32216 33215 32218 32218 32218 32218 HM218248Z/10 HM218248Z/10		 - Ch.1871409 - Ch.1871409 Ch.1871410 - Ch.1871595 Ch.1871410 - Ch.1871595 Ch.1871596 - Ch.1871596 - - Ch.1871409 - Ch.1871409 - Ch.1871409 - Ch.1871409 Ch.1871410 - Ch.1871410 -
BR 86					
	R 640 R 640 R 640 R 640 R 653 R 653	32312 32309 32312 32309 32308 32311 32308	32216 32215 32216 33215 32218 32218		Ch.1802873 - Ch.1802873 - - Ch.1801229 Ch.1801230 - Ch.1801230 - - Ch.1801229 - Ch.1801229 Ch.1801230 - Ch.1801230 -















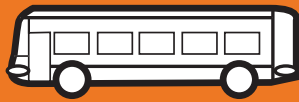













































APPLICATION LISTINGS - BUS

A

SCANIA						
BR 86 ...						
	R 653 R 653 R 653 R 653		32218 32218 HM218248Z/10 HM218248Z/10			- Ch.1801229 - Ch.1801229 Ch.1801230 - Ch.1801230 -
BR/N 112						
	R 653 R 653 R 653 R 653 TRAILING AXLE TRAILING AXLE	32312 32309 32312 32309	32218 32218 HM218248Z/10 HM218248Z/10 HM218248Z/10 HM218248Z/10			5" 5" 7" Ch.1801196 - 7" Ch.1801196 - Ch.1801195 - Ch.1801195 - - Ch.1801196 - Ch.1801196
BR 116						
	R 653 / R 750 R 653 / R 750 R 653 / R 750 R 653 / R 750	32312 32309 32312 32309 32312 32309 32308 32311 32308	HM218248Z/10 HM218248Z/10 32218 32218			-Ch.1801229 -Ch.1801229 Ch.1801230 - Ch.1802872 Ch.1801230 - Ch.1802872 Ch.1802873 - Ch.1802873 - - Ch.1801229 Ch.1801230 - Ch.1801230 - Ch.1801230 - - Ch.1801229 - Ch.1801229
F/S 82 CL						
	AM 60 AM 60 R 642 / R 653 R 642 / R 653	32312 32309	HM218248Z/10 HM218248Z/10			
F/S 112 CL						
	AM 55 AM 55 AM 55 AM 55 AM 60 AM 60 R 642 / R 653 / R 750 R 642 / R 653 / R 750	32311 32308 32311 32308 32312 32309	HM218248Z/10 HM218248Z/10			- Ch.1808231 - Ch.1808231 Ch.1808232 - Ch.1808232 -
K 82						
	AM 60 AM 60 R 750 R 750 R 642 / R 653	32312 32309	HM218248Z/10 HM218248Z/10 HM218248Z/10			



APPLICATION LISTINGS - BUS

				
SCANIA				
K 82 ...				
	R 642 / R 653		HM218248Z/10	 
K 112 CLB				
	R 653 / R 750 R 653 / R 750	32312 32309	HM218248Z/10 HM218248Z/10	  
K 113 CLB				
	AM 56 AM 56 AM 61 / AMA 61 AM 61 / AMA 61 AM 61 / AMA 61 AM 61 / AMA 61 AMA 56 AMA 56 AMA 56 AMA 56 AD 90 / ADA 90 AD 90 / ADA 90	JF6049/10 32309 32312 32309 32312 32309 JF6049/10 32309 JF6049/10 32309	HM218248Z/10 HM218248Z/10	 22.5"   22.5"     22.5"   22.5"   22.5"   22.5"  -Ch.1801229 -Ch.1801229
K 113 TLA/TLB				
	AMA 56 AMA 56 AMA 56 AMA 56 AMA 61 AMA 61 AMA 61 AMA 61 ADA 90 ADA 90 TRAILING AXLE TRAILING AXLE	JF6049/10 32309 JF6049/10 32309 32312 32309 32312 32309 32312 32309 32312 32309	HM218248Z/10 HM218248Z/10 32312 32309	 8.25x22.5"  8.25x22.5"  8.25x22.5"   8.25x22.5"   8.25x22.5"   8.25x22.5"   8.25x22.5"   8.25x22.5"   9x22.5"   9x22.5"   9x22.5"    9x22.5"   -Ch.1801229 -Ch.1801229 -Ch.1801229 -Ch.1801229
K 92 CL/CR				
		32312 32309	HM218248Z/10 HM218248Z/10	  -Ch.1801229 -Ch.1801229
K 93 CRB				
	AM 56 AM 56 AM 56 AM 56 AM 61 / AMA 61 AM 61 / AMA 61 AM 61 / AMA 61	JF6049/10 32309 JF6049/10 32309 32312 32309 32312		     





APPLICATION LISTINGS - BUS

A



































































SCANIA				
K 93 CRB ...				
	AM 61 / AMA 61 AD 90 / ADA 90 AD 90 / ADA 90	32309	HM218248Z/10 HM218248Z/10	 8 -Ch.1801229 -Ch.1801229
L 113 B				
	AM 61 / AMA 61 AM 61 / AMA 61 AM 61 / AMA 61 AM 61 / AMA 61 AMA 56 AMA 56 AMA 56 AMA 56 AMA 56 AD 90 / ADA 90 AD 90 / ADA 90	32312 32309 32312 32309 JF6049/10 32309 JF6049/10 32309	HM218248Z/10 HM218248Z/10	 ABS ABS 22.5 22.5 22.5 22.5 -Ch.1801229 -Ch.1801229
N 111 AL				
	R 653 R 653	32312 32309	HM218248Z/10 HM218248Z/10 HM218248Z/10 HM218248Z/10	 -Ch.1808901,Ch.1808902 - -Ch.1808901,Ch.1808902 - - Ch.1806768, Ch.1806769 - - Ch.1806768, Ch.1806769 -
N 112 CLB				
	R 653 / R 750 R 653 / R 750	32312 32309	HM218248Z/10 HM218248Z/10	 -Ch.1808901,Ch.1808902 - -Ch.1808901,Ch.1808902 - - Ch.1806768, Ch.1806769 - - Ch.1806768, Ch.1806769 -
N 113 ALB				
	AMA 56 AMA 56 AMA 56 AMA 56 AMA 56 AMA 56 AMA 56 AMA 56 ADA 90 ADA 90 ASA 90 ASA 90	JF6049/10 32309 JF6049/10 32309 32312 32309 32312 32309	HM218248Z/10 HM218248Z/10 HM218248Z/10 HM218248Z/10	 6.5 T 6.5 T 6.5 T 6.5 T 7.1 T 7.1 T 6.5 T - Ch.1820117 6.5 T - Ch.1820117 ABS ABS -Ch.1801229 -Ch.1801229
N 113 CLB/CRB				
	AMA 56 AMA 56 AMA 56 AMA 56 AMA 56 AMA 56 AMA 56 AMA 56	JF6049/10 32309 JF6049/10 32309 JF6049/10 32309 32312 32309 32312	HM218248Z/10 HM218248Z/10 HM218248Z/10 HM218248Z/10	 6.5 T -Ch.1820117 6.5 T -Ch.1820117 6.5 T - Ch.1820117 6.5 T - Ch.1820117 7.1 T - Ch.1820117 7.1 T - Ch.1820117 7.1 T - Ch.1820117 7.1 T - Ch.1820117





APPLICATION LISTINGS - BUS



										
SCANIA										
N 113 CLB/CRB ...										
	AMA 56	32309			      	7.1 T - Ch.1820117 				
	AMA 61	32312				 Ch.1820118 -				
	AMA 61	32309				 Ch.1820118 -				
	AMA 61	32312				 Ch.1820118 - 				
	AMA 61	32309				 Ch.1820118 - 				
	ADA 90		HM218248Z/10			- Ch.1820117				
	ADA 90		HM218248Z/10			- Ch.1820117				
S 82 HR										
	AM 55	32311			   					
	AM 55	32308								
	R 653		HM218248Z/10							
	R 653		HM218248Z/10							
VOLVO										
B 6										
		JF7049A/10			   	Ch.865 [exc.873-875] 				
		39580/39520				Ch.865 [exc.873-875] 				
		32210								
		32207								
B 6 F										
		JF7049A/10			     	Ch.865 [exc.873-875] 				
		39580/39520				Ch.865 [exc.873-875] 				
		32210								
		32207								
			33015							
			33013							
B 6 FA										
		JM207049/10			       	Ch.5000 -				
		32208				-Ch.404  6772232				
		33208				-Ch.404  6772232				
						-Ch.404  6010088				
						-Ch.404  6010088				
			33018			Ch.405 -				
			33015			Ch.5000 -				
			33018			Ch.5000 -				
			33015							
			33022							
			47678/47620							
			39580/39520							
B 7										
		JF7049A/10			  	Ch.20000 -				
		39580/39520				Ch.20000 -				
			594/592A			Ch.20000 -				
			580/572			Ch.20000 -				
B 7 F/FA										
		6386/6320			   	- Ch.10521 				
		537/532X				- Ch.10521 				
		JF7049A/10				Ch.10522 - 				
		39580/39520				Ch.10522 - 				





APPLICATION LISTINGS - BUS

A



VOLVO					
B 7 F/FA ...					
			683/672 663/653		
B 7 R					
		JF7049A/10 39580/39520	683/672 663/653		
B 9 M/10 M					
	TRAILING AXLE TRAILING AXLE TRAILING AXLE TRAILING AXLE TRAILING AXLE TRAILING AXLE TRAILING AXLE	JF7049A/10 39580/39520 6386/6320 537/532X	JF7049A/10 39580/39520 JF7049A/10 39580/39520 6386/6320 537/532X 683/672 663/653		
B 10 B/BL/L					
	TRAILING AXLE TRAILING AXLE TRAILING AXLE TRAILING AXLE TRAILING AXLE TRAILING AXLE TRAILING AXLE	JF7049A/10 39580/39520 6386/6320 537/532X	JF7049A/10 39580/39520 JF7049A/10 39580/39520 6386/6320 537/532X 683/672 663/653		
B 10 R					
		JF7049A/10 39580/39520 JF7049A/10 39580/39520 6386/6320 537/532X	683/672 663/653		Ch.3906 - Ch.3906 - Ch.4308 - ABS Ch.4308 - ABS - Ch.3906 - Ch.3906
B 12					
	TRAILING AXLE TRAILING AXLE	JF7049A/10 39580/39520	JF7049A/10 39580/39520 683/672 663/653		





APPLICATION LISTINGS - BUS

A



VOLVO					
B/BB 57					
		6386/6320 537/532X 6386/6320 537/532X	594/592A 580/572 594/592A 580/572 594/592A 580/572		- Ch.7980 - Ch.7980 Ch.7981 - Ch.7981 - Ch.7981 - Ch.7981 - - Ch.3404 - Ch.3404 Ch.3405 - Ch.7980 Ch.3405 - Ch.7980
B 58					
		6386/6320 537/532X	594/592A 580/572 594/592A 580/572 594/592A 580/572		Ch.5257 - Ch.5257 - - Ch.5256 - Ch.5256
B 59					
		6386/6320 537/532X	683/672 663/653		
B 609/610					
			33015 33013		





NOTES

A

Lined writing area with horizontal orange lines.



APPLICATION LISTINGS - LIGHT COMMERCIAL VEHICLE

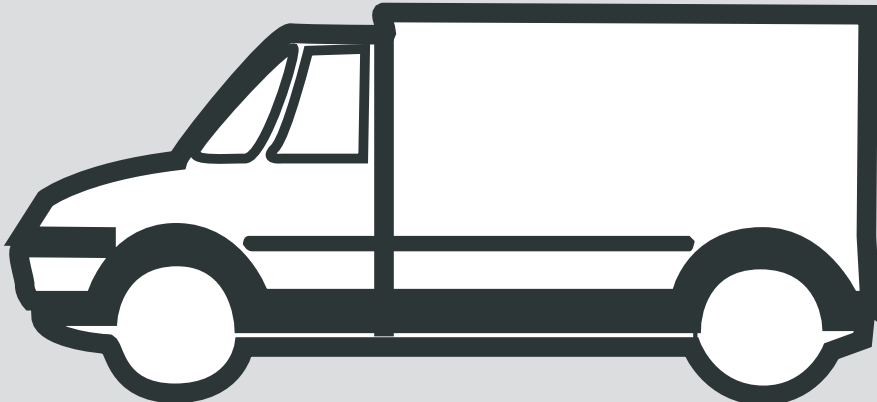

A



APPLICATION LISTINGS - LIGHT COMMERCIAL VEHICLE



























● ● ● ● ● ● ● ● ● ● **APPLICATION LISTINGS - LIGHT COMMERCIAL VEHICLE**

CITROEN											
C25											
	1000	XAA32010X									- Ch. 604496
	1000	XAA32010X									- Ch. 604496
	1000	XAA32010X									Ch. 604497 -
	1000	XAA32010X									Ch. 604497 -
	1300	XAA32010X									- Ch. 604496
	1300	XAA32010X									- Ch. 604496
	1400	XAA32010X									- Ch. 604496
	1400	XAA32010X									- Ch. 604496
	1400	XAA32010X									Ch. 604497 -
	1400	XAA32010X									Ch. 604497 -
	1800	XAA32010X									- Ch. 604496
	1800	XAA32010X									- Ch. 604496
	1800	XAA32010X									Ch. 604497 -
	1800	XAA32010X									Ch. 604497 -
	1000		XAA32008X								- Ch. 289710
	1000		32006X								- Ch. 289710
	1000		XAA32008X								Ch. 289711 -
	1000		32006X								Ch. 289711 -
	1300		XAA32008X								- Ch. 289710
	1300		32006X								- Ch. 289710
	1300		XAA32008X								Ch. 289711 -
	1300		32006X								Ch. 289711 -
	1400		XAA32008X								
	1400		32006X								
	1800		XAA33108								
	1800		32206								
JUMPER											
	1000 / 1400KG	XAA32010X									
	1000 / 1400KG	XAA32010X									
	1800KG	JXC25678CA-90KA1									
	1800KG	JXC25678CA-90KA1									
	1000 / 1400KG		XAA32008X								
	1000 / 1400KG		32006X								
	1800KG		XAA33108								
	1800KG		32206								
DAF											
F400 SERIES											
	28 N	L68149/10									
	28 N	07087X/07210X									
	206		U497/U460L								
	206		U497/U460L								
	306		18790/18720								
	306		18690/18620								
FORD											
CARGO											
	30	25590/25520									
	30	LM48548/10									



APPLICATION LISTINGS - LIGHT COMMERCIAL VEHICLE

A

				 			
FORD							
CARGO ...							
	50 N		39581/39520				
	50 N		3585/3525				
	50 W		39581/39520				
	50 W		3585/3525				
	65		HM215249/10				
	65		3780/3720				
	71		HM215249/10				
	71		3780/3720				
	130			33287/33462			
	130			3984/3920			
	150			33287/33462			
	150			3984/3920			
	165			495A/493			
	165			3984/3920			
	168			495A/493			
	168			3984/3920			
	195			47686/47620			
	195			39590/39520			
	225			594/592A			
	225			580/572			
TRANSIT FT 130 - 150							
	51			NP958644-9X048			1992 - 1999
	51			NP958644-9X048			1992 - 1999
TRANSIT FT 190 - L							
	51			NP958644-9X048			1992 - 1999
	51			NP958644-9X048			1992 - 1999
TRANSIT 2000 VAN [FA--,FAA--,FAB--,FAC--]							
				XAA32011XM-90NM5			01/00-07/06 [+Rear 
				XAA32011XM-90NM5			01/00-07/06 [+Rear 
TRANSIT 2000 FLATBED/CHASSIS [FM-,FN-,F_A_,F_B_,F_C_,F_D_]							
				XAA32011XM-90NM5			01/00-07/06 [+Rear 
				XAA32011XM-90NM5			01/00-07/06 [+Rear 
TRANSIT 2000 BUS							
				XAA32011XM-90NM5			01/00-07/06 [+Rear 
IVECO							
DAILY 28 - 8							
			28150/28300				10/77 - 05/79
			30305				10/77 - 05/79
			32208				06/79 - 06/81
			30305				06/79 - 06/81
	SALISBURY			18790/18720			10/77 - 06/81
	SALISBURY			18690/18620		10/77 - 06/81	
DAILY 30 - 8							
			28150/28300				10/77 - 05/79
			30305				10/77 - 05/79



● ● ● ● ● ● ● ● ● ● **APPLICATION LISTINGS - LIGHT COMMERCIAL VEHICLE**

















IVECO						
DAILY 30 - 8 ...						
	IVECO	32208			06/79 - 01/97	
	IVECO	30305			06/79 - 01/97	
	SALISBURY	368A/362A			06/81 - 09/84	
	SALISBURY	18690/18620			06/81 - 09/84	
	IVECO		32011X		06/81 - 01/97	
	IVECO		32011X		06/81 - 01/97	
	SALISBURY 1 AXLE		368A/362A		10/77 - 06/81	
	SALISBURY 1 AXLE		18690/18620		10/77 - 06/81	
DAILY 30 - 9						
	IVECO	32208			06/81 - 1988	
	IVECO	30305			06/81 - 1988	
	SALISBURY	368A/362A			06/81 - 09/84	
	SALISBURY	18690/18620			06/81 - 09/84	
	IVECO		32011X		10/84 - 1988	
	IVECO		32011X		10/84 - 1988	
	SALISBURY 1 AXLE		18790/18720		06/81 - 09/84	
	SALISBURY 1 AXLE		18690/18620		06/81 - 09/84	
DAILY 32 - 8						
		28150/28300			10/77 - 05/79	
		30305			10/77 - 05/79	
		32208			06/79 - 06/81	
		30305			06/79 - 06/81	
	SALISBURY 1 AXLE		368A/362A			10/77 - 06/81
	SALISBURY 1 AXLE		18690/18620			10/77 - 06/81
DAILY 35 - 8						
		28150/28300			10/77 - 05/79	
		30305			10/77 - 05/79	
	IVECO	32208			06/79 - 02/96	
	IVECO	30305			06/79 - 02/96	
	SALISBURY	368A/362A			06/81 - 09/84	
	SALISBURY	18690/18620			06/81 - 09/84	
	IVECO		32011X		Exc. Ratio 5.22/1, -02/96	
	IVECO		32011X		Exc. Ratio 5.22/1, -02/96	
	IVECO		33111		Ratio 5.22/1, -02/96	
	IVECO		32011X		Ratio 5.22/1, -02/96	
	IVECO		32011X		03/96 -	
	IVECO		32011X		03/96 -	
	SALISBURY 1 AXLE		18790/18720		10/77 - 09/84	
	SALISBURY 1 AXLE		18690/18620		10/77 - 09/84	
	SALISBURY 2 AXLE		387A/382	10/77 - 06/81		
	SALISBURY 2 AXLE		368A/362A	10/77 - 06/81		
DAILY 35 - 8 HEAVY DUTY						
	IVECO	32208				
	IVECO	30305				
	IVECO		32011X			
	IVECO		32011X			
DAILY 35 - 9						
	IVECO	32208			06/81 - 09/84	
	IVECO	30305			06/81 - 09/84	

















APPLICATION LISTINGS - LIGHT COMMERCIAL VEHICLE

A

					
IVECO					
DAILY 35 - 9 ...					
	IVECO IVECO SALISBURY 1 AXLE SALISBURY 1 AXLE		32011X 32011X 18790/18720 18690/18620		06/81 - 09/84 06/81 - 09/84 06/81 - 09/84 06/81 - 09/84
DAILY 35 - 10					
		32208 30305	32011X 32011X 33111 32011X		Exc. Iveco check control Exc. Iveco check control Iveco check control Iveco check control
DAILY 35 - 10 TURBODAILY					
			32011X 32011X		9 01/96-12/99 9 01/96-12/99
DAILY 35 - 12 TURBODAILY					
		33208 33206	32011X 32011X		- 02/96 - 02/96 [03/96 -] ABS [-12/99] [03/96 -] ABS [-12/99]
DAILY 40 - 8					
	IVECO IVECO SALISBURY SALISBURY SALISBURY 1 AXLE SALISBURY 1 AXLE SALISBURY 2 AXLE SALISBURY 2 AXLE IVECO IVECO	28150/28300 30305 32208 30305 368A/362A 18690/18620	18790/18720 18690/18620 387A/382 368A/362A 32011X 32011X		10/77 - 05/79 10/77 - 05/79 06/79 - 02/96 06/79 - 02/96 06/81 - 09/84 06/81 - 09/84 06/81 - 09/84 06/81 - 09/84 10/77 - 06/81 10/77 - 06/81 - 02/96 - 02/96
DAILY 40 - 8 HEAVY DUTY					
		32208 30305	32011X 32011X		
DAILY 45 - 10					
		33208 33206	32011X 32011X 33111 32011X		Ratio 5.62/1 Ratio 5.62/1 Exc. Ratio 5.62/1 Exc. Ratio 5.62/1
DAILY 49 - 10					
		33208 33206			

APPLICATION LISTINGS - LIGHT COMMERCIAL VEHICLE















					
IVECO					
DAILY 49 - 10 ...					
			32011X 32011X 33111 32011X		
DAILY 49 - 12 TURBODAILY					
		33208 33206	33111 32011X		- 02/96 - 02/96 - 02/96 - 02/96
DAILY 59 - 12 TURBODAILY					
			XC2379CD/DA XC2379CD/DA		
DUCATO I 10					
		XAA32010X XAA32010X XAA32010X XAA32010X	XAA32008X 32006X XAA32008X 32006X		- Ch. 604496 [1982 - 1989] - Ch. 604496 [1982 - 1989] Ch. 604497 - [1989 - 1993] Ch. 604497 - [1989 - 1993] - Ch. 278757 [1982 - 1986] - Ch. 278757 [1982 - 1986] Ch. 278758 - [1986 - 1993] Ch. 278758 - [1986 - 1993]
DUCATO 13					
		XAA32010X XAA32010X	XAA32008X 32006X XAA32008X 32006X		1982 - 1986 1982 - 1986 - Ch. 278757 [1982 - 1986] - Ch. 278757 [1982 - 1986] Ch. 278758 - [1986 - 1993] Ch. 278758 - [1986 - 1993]
DUCATO I 14					
		XAA32010X XAA32010X XAA32010X XAA32010X	XAA32008X 32006X		- Ch. 604496 [1986 - 1989] - Ch. 604496 [1986 - 1989] Ch. 604497 - [1989 - 1993] Ch. 604497 - [1989 - 1993] 1986 - 1993 1986 - 1993
DUCATO I MAXI 18					
		XAA32010X XAA32010X XAA32010X XAA32010X	XAA33108 32206		- Ch. 604496 [1986 - 1989] - Ch. 604496 [1986 - 1989] Ch. 604497 - [1989 - 1993] Ch. 604497 - [1989 - 1993]
DUCATO II 10 [4X2]					
		XAA32010X XAA32010X	XAA32008X 32006X		

A



APPLICATION LISTINGS - LIGHT COMMERCIAL VEHICLE

A

				 			
IVECO							
DUCATO II 10 [4X4]							
		XAA32010X XAA32010X		XAA32010X XAA32010X			
DUCATO II 14 [4X2]							
		XAA32010X XAA32010X		XAA32008X 32006X			
DUCATO II 14 [4X4]							
		XAA32010X XAA32010X		XAA32010X XAA32010X			
DUCATO II 18 [4X2]							
		JXC25678CA-90KA1 JXC25678CA-90KA1		XAA33108 32206			
DUCATO II 18 [4X4]							
		JXC25678CA-90KA1 JXC25678CA-90KA1		XAA32010X XAA32010X			
GRINTA 28 - 8							
	SALISBURY AXLE 1 SALISBURY AXLE 1	28150/28300 30305 32208 30305		18790/18720 18690/18620			10/77 - 05/79 10/77 - 05/79 06/79 - 06/81 06/79 - 06/81 10/77 - 06/81 10/77 - 06/81
GRINTA 30 - 8							
	IVECO IVECO SALISBURY SALISBURY SALISBURY AXLE 1 SALISBURY AXLE 1 IVECO IVECO	28150/28300 30305 32208 30305 32208 30305 368A/362A 18690/18620		368A/362A 18690/18620 32011X 32011X			10/77 - 05/79 10/77 - 05/79 06/79 - 06/81 06/79 - 06/81 06/81 - 09/84 06/81 - 09/84 06/81 - 09/84 06/81 - 09/84 10/77 - 06/81 10/77 - 06/81 06/81 - 09/84 06/81 - 09/84
GRINTA 30 - 9							
	IVECO IVECO	32208 30305					06/81 - 09/84 06/81 - 09/84

● ● ● ● ● ● ● ● ● ● APPLICATION LISTINGS - LIGHT COMMERCIAL VEHICLE













IVECO					
GRINTA 30 - 9 ...					
	SALISBURY SALISBURY SALISBURY AXLE 1 SALISBURY AXLE 1	368A/362A 18690/18620	18790/18720 18690/18620		06/81 - 09/84 06/81 - 09/84 06/81 - 09/84 06/81 - 09/84
GRINTA 32 - 8					
	IVECO IVECO SALISBURY AXLE 1 SALISBURY AXLE 1	28150/28300 30305 32208 30305	368A/362A 18690/18620		10/77 - 05/79 10/77 - 05/79 06/79 - 06/81 06/79 - 06/81 10/77 - 06/81 10/77 - 06/81
GRINTA 35 - 8					
	IVECO IVECO SALISBURY SALISBURY SALISBURY AXLE 1 SALISBURY AXLE 1 SALISBURY AXLE 1 SALISBURY AXLE 1	28150/28300 30305 32208 30305 32208 30305 368A/362A 18690/18620	18790/18720 18690/18620 18790/18720 18690/18620		10/77 - 05/79 10/77 - 05/79 06/79 - 06/81 06/79 - 06/81 06/81 - 09/84 06/81 - 09/84 06/81 - 09/84 06/81 - 09/84 10/77 - 06/81 10/77 - 06/81 06/81 - 09/84 06/81 - 09/84
GRINTA 35 - 9					
	IVECO IVECO IVECO IVECO SALISBURY SALISBURY	32208 30305	32011X 32011X 18790/18720 18690/18620		06/81 - 09/84 06/81 - 09/84 06/81 - 09/84 06/81 - 09/84 06/81 - 09/84 06/81 - 09/84
GRINTA 40 - 8					
	IVECO IVECO SALISBURY SALISBURY SALISBURY 2 AXLE SALISBURY 2 AXLE SALISBURY 1 AXLE SALISBURY 1 AXLE	28150/28300 30305 32208 30305 32208 30305 368A/362A 18690/18620	387A/382 368A/362A 18790/18720 18690/18620		10/77 - 05/79 10/77 - 05/79 06/79 - 06/81 06/79 - 06/81 06/81 - 09/84 06/81 - 09/84 06/81 - 09/84 06/81 - 09/84 10/77 - 06/81 10/77 - 06/81 06/81 - 09/84 06/81 - 09/84
GRINTA SERIES S [30 - 9 / 35 - 8 / 35 - 10 / 40 - 8 / 40 - 10]					
	IVECO IVECO IVECO IVECO	32208 30305	32011X 32011X		10/84 - 1988 10/84 - 1988 10/84 - 1988 10/84 - 1988



APPLICATION LISTINGS - LIGHT COMMERCIAL VEHICLE

A

				 			
IVECO							
GRINTA SERIES S TURBO [45 - 10 / 49 - 10]							
		33208 33206		33111 32010X			03/85 - 1988 03/85 - 1988 03/85 - 1988 03/85 - 1988
PEUGEOT							
BOXER							
	1000 / 1400 KG 1000 / 1400 KG 1800 KG 1800 KG 1000 / 1400 KG 1000 / 1400 KG 1800 KG 1800 KG	XAA32010X XAA32010X JXC25678CA JXC25678CA		XAA32008X 32006X XAA33108/Y33108 32206			
J 5							
	1000 / 1300 KG 1000 / 1300 KG 1000 / 1300 KG 1000 / 1300 KG 1400 KG 1400 KG 1400 KG 1400 KG 180Q / 1800 KG 180Q / 1800 KG 180Q / 1800 KG 180Q / 1800 KG 1000 / 1300 KG 1000 / 1300 KG 1000 / 1300 KG 1000 / 1300 KG 1400 KG 1400 KG 180Q / 1800 KG 180Q / 1800 KG	XAA32010X XAA32010X XAA32010X XAA32010X XAA32010X XAA32010X XAA32010X XAA32010X XAA32010X XAA32010X XAA32010X XAA32010X XAA32008X 32006X XAA32008X 32006X XAA32008X 32006X XAA33108/Y33108 32206					- Ch. 604496 - Ch. 604496 Ch. 604497 - Ch. 604497 - - Ch. 604496 - Ch. 604496 Ch. 604497 - Ch. 604497 - - Ch. 604496 - Ch. 604496 Ch. 604497 - - Ch. 604496 Ch. 604497 - - Ch. 604496 Ch. 604497 - - Ch. 244300 - Ch. 244300 Ch. 244301 - Ch. 244301 -
RENAULT RVI							
MASCOTT 3.5 T - 5.5 T							
	RIGID RIGID	33108 33206					
MASCOTT 5.5 T - 6.5 T							
	RIGID RIGID P669	33108 33206		32012X			













● ● ● ● ● ● ● ● ● ● **APPLICATION LISTINGS - LIGHT COMMERCIAL VEHICLE**

MERCEDES - BENZ					
307 D					
	VL 1/3 - 2.1	2789/2720			- Ch. 48630
	VL 1/3 - 2.1	1380/1328			- Ch. 48630
	VL 1/3 - 2.1	33109			Ch. 48631 -
	VL 1/3 - 2.1	33205			Ch. 48631 -
308					
	VL 1/3 - 2.1	2789/2720			- Ch. 48630
	VL 1/3 - 2.1	1380/1328			- Ch. 48630
	VL 1/3 - 2.1	33109			Ch. 48631 -
	VL 1/3 - 2.1	33205			Ch. 48631 -
308 D					
	VL 1/3 - 2.1	2789/2720			- Ch. 48630
	VL 1/3 - 2.1	1380/1328			- Ch. 48630
	VL 1/3 - 2.1	33109			Ch. 48631 -
	VL 1/3 - 2.1	33205			Ch. 48631 -
309					
	VL 1/3 - 2.1	2789/2720			- Ch. 48630
	VL 1/3 - 2.1	1380/1328			- Ch. 48630
	VL 1/3 - 2.1	33109			Ch. 48631 -
	VL 1/3 - 2.1	33205			Ch. 48631 -
309 D					
	VL 1/3 - 2.1	2789/2720			- Ch. 48630
	VL 1/3 - 2.1	1380/1328			- Ch. 48630
	VL 1/3 - 2.1	33109			Ch. 48631 -
	VL 1/3 - 2.1	33205			Ch. 48631 -
310					
	VL 1/3 - 2.1	2789/2720			- Ch. 48630
	VL 1/3 - 2.1	1380/1328			- Ch. 48630
	VL 1/3 - 2.1	33109			Ch. 48631 -
	VL 1/3 - 2.1	33205			Ch. 48631 -
310 D					
	VL 1/3 - 2.1	2789/2720			- Ch. 48630
	VL 1/3 - 2.1	1380/1328			- Ch. 48630
	VL 1/3 - 2.1	33109			Ch. 48631 -
	VL 1/3 - 2.1	33205			Ch. 48631 -
312					
	VL 1/3 - 2.1	2789/2720			- Ch. 48630
	VL 1/3 - 2.1	1380/1328			- Ch. 48630
	VL 1/3 - 2.1	33109			Ch. 48631 -
	VL 1/3 - 2.1	33205			Ch. 48631 -
314					
	VL 1/3 - 2.1	2789/2720			- Ch. 48630
	VL 1/3 - 2.1	1380/1328			- Ch. 48630
	VL 1/3 - 2.1	33109			Ch. 48631 -
	VL 1/3 - 2.1	33205			Ch. 48631 -













APPLICATION LISTINGS - LIGHT COMMERCIAL VEHICLE

A

					
MERCEDES - BENZ					
315					
	VL 1/3 - 2.1	2789/2720			- Ch. 48630
	VL 1/3 - 2.1	1380/1328			- Ch. 48630
	VL 1/3 - 2.1	33109			Ch. 48631 -
	VL 1/3 - 2.1	33205			Ch. 48631 -
406					
	VL 1/3 - 2.1	2789/2720			- Ch. 48630
	VL 1/3 - 2.1	1380/1328			- Ch. 48630
	VL 1/3 - 2.1	33109			Ch. 48631 -
	VL 1/3 - 2.1	33205			Ch. 48631 -
	VL 1/4 - 1.6	32304			-Ch.17768 Diesel, -Ch.1288 Petrol
	VL 1/4 - 1.6	32207			-Ch.17768 Diesel, -Ch.1288 Petrol
	VL 1/4 - 1.6	2789/2720			Ch.17769 - Ch.17814 Diesel,
					Ch.1289 - Ch.4706 Petrol
	VL 1/4 - 1.6	1380/1328			Ch.17769 - Ch.17814 Diesel,
					Ch.1289 - Ch.4706 Petrol
	VL 1/4 - 1.6	33109	32011X		Ch.17815- Diesel, Ch.4707- Petrol
	VL 1/4 - 1.6	33205	32210		Ch.17815- Diesel, Ch.4707- Petrol
	HL 03 - 3.3		32211		
	HL 1/2 - 3.3		32210		
406 D					
	VL 1/3 - 2.1	2789/2720			- Ch. 48630
	VL 1/3 - 2.1	1380/1328			- Ch. 48630
	VL 1/3 - 2.1	33109			Ch. 48631 -
	VL 1/3 - 2.1	33205			Ch. 48631 -
	VL 1/4 - 1.6	32304			-Ch.17768 Diesel, -Ch.1288 Petrol
	VL 1/4 - 1.6	32207			-Ch.17768 Diesel, -Ch.1288 Petrol
	VL 1/4 - 1.6	2789/2720			Ch.17769 - Ch.17814 Diesel,
					Ch.1289 - Ch.4706 Petrol
	VL 1/4 - 1.6	1380/1328			Ch.17769 - Ch.17814 Diesel,
					Ch.1289 - Ch.4706 Petrol
	VL 1/4 - 1.6	33109	32011X		Ch.17815- Diesel, Ch.4707- Petrol
	VL 1/4 - 1.6	33205	32210		Ch.17815- Diesel, Ch.4707- Petrol
	HL 03 - 3.3		32211		
	HL 1/2 - 3.3		32210		
407					
	VL 1/3 - 2.1	2789/2720			- Ch. 48630
	VL 1/3 - 2.1	1380/1328			- Ch. 48630
	VL 1/3 - 2.1	33109			Ch. 48631 -
	VL 1/3 - 2.1	33205			Ch. 48631 -
	VL 1/4 - 1.6	32304			-Ch.17768 Diesel, -Ch.1288 Petrol
	VL 1/4 - 1.6	32207			-Ch.17768 Diesel, -Ch.1288 Petrol
	VL 1/4 - 1.6	2789/2720			Ch.17769 - Ch.17814 Diesel,
					Ch.1289 - Ch.4706 Petrol
	VL 1/4 - 1.6	1380/1328			Ch.17769 - Ch.17814 Diesel,
					Ch.1289 - Ch.4706 Petrol
	VL 1/4 - 1.6	33109			Ch.17815- Diesel, Ch.4707- Petrol
	VL 1/4 - 1.6	33205		Ch.17815- Diesel, Ch.4707- Petrol	













● ● ● ● ● ● ● ● ● ● **APPLICATION LISTINGS - LIGHT COMMERCIAL VEHICLE**

					
MERCEDES - BENZ					
407 ...					
	HL 03 - 3.3 HL 03 - 3.3 HL 1/2 - 3.3 HL 1/2 - 3.3		32011X 32210 32211 32210		
407 D					
	VL 1/3 - 2.1 VL 1/3 - 2.1 VL 1/3 - 2.1 VL 1/3 - 2.1 VL 1/4 - 1.6 VL 1/4 - 1.6 VL 1/4 - 1.6 VL 1/4 - 1.6 VL 1/4 - 1.6 VL 1/4 - 1.6 HL 03 - 3.3 HL 03 - 3.3 HL 1/2 - 3.3 HL 1/2 - 3.3	2789/2720 1380/1328 33109 33205 32304 32207 2789/2720 1380/1328 33109 33205	32011X 32210 32211 32210		- Ch. 48630 - Ch. 48630 Ch. 48631 - Ch. 48631 - -Ch.17768 Diesel, -Ch.1288 Petrol -Ch.17768 Diesel, -Ch.1288 Petrol Ch.17769 - Ch.17814 Diesel, Ch.1289 - Ch.4706 Petrol Ch.17769 - Ch.17814 Diesel, Ch.1289 - Ch.4706 Petrol Ch.17815- Diesel, Ch.4707- Petrol Ch.17815- Diesel, Ch.4707- Petrol
408					
	VL 1/3 - 2.1 VL 1/3 - 2.1 VL 1/3 - 2.1 VL 1/3 - 2.1 VL 1/4 - 1.6 VL 1/4 - 1.6 VL 1/4 - 1.6 VL 1/4 - 1.6 VL 1/4 - 1.6 VL 1/4 - 1.6 HL 03 - 3.3 HL 03 - 3.3 HL 1/2 - 3.3 HL 1/2 - 3.3	2789/2720 1380/1328 33109 33205 32304 32207 2789/2720 1380/1328 33109 33205	32011X 32210 32211 32210		- Ch. 48630 - Ch. 48630 Ch. 48631 - Ch. 48631 - -Ch.17768 Diesel, -Ch.1288 Petrol -Ch.17768 Diesel, -Ch.1288 Petrol Ch.17769 - Ch.17814 Diesel, Ch.1289 - Ch.4706 Petrol Ch.17769 - Ch.17814 Diesel, Ch.1289 - Ch.4706 Petrol Ch.17815- Diesel, Ch.4707- Petrol Ch.17815- Diesel, Ch.4707- Petrol
408 D					
	VL 1/3 - 2.1 VL 1/3 - 2.1 VL 1/3 - 2.1 VL 1/3 - 2.1 VL 1/4 - 1.6 VL 1/4 - 1.6 VL 1/4 - 1.6 VL 1/4 - 1.6 VL 1/4 - 1.6 VL 1/4 - 1.6	2789/2720 1380/1328 33109 33205 32304 32207 2789/2720 1380/1328 33109 33205			- Ch. 48630 - Ch. 48630 Ch. 48631 - Ch. 48631 - -Ch.17768 Diesel, -Ch.1288 Petrol -Ch.17768 Diesel, -Ch.1288 Petrol Ch.17769 - Ch.17814 Diesel, Ch.1289 - Ch.4706 Petrol Ch.17769 - Ch.17814 Diesel, Ch.1289 - Ch.4706 Petrol Ch.17815- Diesel, Ch.4707- Petrol Ch.17815- Diesel, Ch.4707- Petrol













APPLICATION LISTINGS - LIGHT COMMERCIAL VEHICLE

A







					
MERCEDES - BENZ					
408 D ...					
	HL 03 - 3.3			32011X	
	HL 03 - 3.3			32210	
	HL 1/2 - 3.3			32211	
	HL 1/2 - 3.3			32210	
408 G					
	VL 1/3 - 2.1	2789/2720			
	VL 1/3 - 2.1	1380/1328			
	VL 1/3 - 2.1	33109			
	VL 1/3 - 2.1	33205			
	VL 1/4 - 1.6	32304			
	VL 1/4 - 1.6	32207			
	VL 1/4 - 1.6	2789/2720			
	VL 1/4 - 1.6	1380/1328			
	VL 1/4 - 1.6	33109		32011X	
	VL 1/4 - 1.6	33205		32210	
	HL 03 - 3.3			32211	
	HL 03 - 3.3			32210	
	HL 1/2 - 3.3				
	HL 1/2 - 3.3				
409					
	VL 1/3 - 2.1	2789/2720			
	VL 1/3 - 2.1	1380/1328			
	VL 1/3 - 2.1	33109			
	VL 1/3 - 2.1	33205			
	VL 1/4 - 1.6	32304			
	VL 1/4 - 1.6	32207			
	VL 1/4 - 1.6	2789/2720			
	VL 1/4 - 1.6	1380/1328			
	VL 1/4 - 1.6	33109		32011X	
	VL 1/4 - 1.6	33205		32210	
	HL 03 - 3.3			32211	
	HL 03 - 3.3			32210	
	HL 1/2 - 3.3				
	HL 1/2 - 3.3				
409 D					
	VL 1/3 - 2.1	2789/2720			
	VL 1/3 - 2.1	1380/1328			
	VL 1/3 - 2.1	33109			
	VL 1/3 - 2.1	33205			
	VL 1/4 - 1.6	32304			
	VL 1/4 - 1.6	32207			
	VL 1/4 - 1.6	2789/2720			
	VL 1/4 - 1.6	1380/1328			
	VL 1/4 - 1.6	33109		32011X	
	VL 1/4 - 1.6	33205		32210	
	HL 03 - 3.3			32211	
	HL 03 - 3.3			32210	
	HL 1/2 - 3.3				
	HL 1/2 - 3.3				

APPLICATION LISTINGS - LIGHT COMMERCIAL VEHICLE

A

					
MERCEDES - BENZ					
412 ...					
	HL 03 - 3.3 HL 03 - 3.3 HL 1/2 - 3.3 HL 1/2 - 3.3		32011X 32210 32211 32210		
414					
	VL 1/3 - 2.1 VL 1/3 - 2.1 VL 1/3 - 2.1 VL 1/3 - 2.1 VL 1/4 - 1.6 VL 1/4 - 1.6 VL 1/4 - 1.6 VL 1/4 - 1.6 VL 1/4 - 1.6 VL 1/4 - 1.6 VL 1/4 - 1.6 VL 1/4 - 1.6 HL 03 - 3.3 HL 03 - 3.3 HL 1/2 - 3.3 HL 1/2 - 3.3	2789/2720 1380/1328 33109 33205 32304 32207 2789/2720 1380/1328 33109 33205	32011X 32210 32211 32210		- Ch. 48630 - Ch. 48630 Ch. 48631 - Ch. 48631 - -Ch.17768 Diesel, -Ch.1288 Petrol -Ch.17768 Diesel, -Ch.1288 Petrol Ch.17769 - Ch.17814 Diesel, Ch.1289 - Ch.4706 Petrol Ch.17769 - Ch.17814 Diesel, Ch.1289 - Ch.4706 Petrol Ch.17815- Diesel, Ch.4707- Petrol Ch.17815- Diesel, Ch.4707- Petrol
415					
	VL 1/3 - 2.1 VL 1/3 - 2.1 VL 1/3 - 2.1 VL 1/3 - 2.1 VL 1/4 - 1.6 VL 1/4 - 1.6 VL 1/4 - 1.6 VL 1/4 - 1.6 VL 1/4 - 1.6 VL 1/4 - 1.6 VL 1/4 - 1.6 VL 1/4 - 1.6 HL 03 - 3.3 HL 03 - 3.3 HL 1/2 - 3.3 HL 1/2 - 3.3	2789/2720 1380/1328 33109 33205 32304 32207 2789/2720 1380/1328 33109 33205	32011X 32210 32211 32210		- Ch. 48630 - Ch. 48630 Ch. 48631 - Ch. 48631 - -Ch.17768 Diesel, -Ch.1288 Petrol -Ch.17768 Diesel, -Ch.1288 Petrol Ch.17769 - Ch.17814 Diesel, Ch.1289 - Ch.4706 Petrol Ch.17769 - Ch.17814 Diesel, Ch.1289 - Ch.4706 Petrol Ch.17815- Diesel, Ch.4707- Petrol Ch.17815- Diesel, Ch.4707- Petrol
500 SERIES					
	VL 1/3 - 2.1 VL 1/3 - 2.1 VL 1/3 - 2.1 VL 1/3 - 2.1 VL 1/6 - 2.3 VL 1/6 - 2.3 VL 1/7 - 2.6 VL 1/7 - 2.6 VL 1/9 C - 2.3 VL 1/9 C - 2.3 HL 0/6 - 3.9 HL 0/6 - 3.9	2789/2720 1380/1328 33109 33205 33109 33205 33109 33205 33109 33205 33109 33205	32012X 32210		- Ch. 48630 - Ch. 48630 Ch. 48631 - Ch. 48631 -

●●●●●●●●●● APPLICATION LISTINGS - LIGHT COMMERCIAL VEHICLE

					
MERCEDES - BENZ					
500 SERIES ...					
	HL 0/7 - 3.2 HL 0/7 - 3.2 HL 1/2 - 3.3 HL 1/2 - 3.3 HL 1/3 - 4.5 HL 1/3 - 4.5 HL 2/5 - 4.5 HL 2/5 - 4.5 HL 2/9 - 4.7 HL 2/9 - 4.7		32011X 32210 32211 32210 3984/3920 33895/33822 3984/3920 33895/33822 3984/3920 33895/33822		

A





NOTES

A

Lined area for notes, consisting of multiple horizontal lines for writing.



B

APPLICATIONS LISTINGS - FINAL DRIVE

B

APPLICATIONS LISTINGS - FINAL DRIVE

B



APPLICATION LISTINGS - FINAL DRIVE

		Application	
DAF			
1132			
	FORWARD AXLE FORWARD AXLE	DIFFERENTIAL-RIGHT DIFFERENTIAL-LEFT	XAA32018X-90KA1 XAA32018X-90KA1
1332			
	FORWARD AXLE FORWARD AXLE	DIFFERENTIAL-RIGHT DIFFERENTIAL-LEFT	XAA32018X-90KA1 XAA32018X-90KA1
1354			
	FORWARD AXLE FORWARD AXLE FORWARD AXLE FORWARD AXLE	PINION-TAIL PINION-HEAD DIFFERENTIAL-RIGHT DIFFERENTIAL-LEFT	3977-99401 52401-99401 497A-99401 47687-99401
1:5.86 - [1305-L0387660]			
	FORWARD AXLE	PINION-HEAD	H715332-99401
1:5.86 - [1305-L1243591]			
	FORWARD AXLE FORWARD AXLE	DIFFERENTIAL-RIGHT DIFFERENTIAL-LEFT	9278-99402 9278-99402
2255 - [1305-0295214]			
	FORWARD AXLE	PINION-TAIL	78214-99401
2255 - [1305-88503]			
	FORWARD AXLE	PINION-HEAD	78225-99401
IVECO			
4517			
	REAR AXLE REAR AXLE	PINION-TAIL PINION-HEAD	HM804848-99401 JW5049-90405
4521			
	REAR AXLE REAR AXLE REAR AXLE REAR AXLE	PINION-TAIL PINION-HEAD DIFFERENTIAL-RIGHT DIFFERENTIAL-LEFT	HM803149-99404 JW5049-90405 JXC25716C-90401 JXC25716C-90401
ARM 125			
	REAR AXLE REAR AXLE REAR AXLE REAR AXLE	PINION-TAIL PINION-HEAD DIFFERENTIAL-RIGHT DIFFERENTIAL-LEFT	HM804846-99401 55206C-99404 34306-99401 3994/JM511910
ARM 145			
	REAR AXLE REAR AXLE REAR AXLE REAR AXLE	PINION-TAIL PINION-HEAD DIFFERENTIAL-RIGHT DIFFERENTIAL-LEFT	HM804846-99401 55206C-99404 JM716649-99401 3994/JM511910

B







APPLICATION LISTINGS - FINAL DRIVE

		Application	
IVECO			
ARM 160			
	REAR AXLE REAR AXLE REAR AXLE	PINION-HEAD DIFFERENTIAL-RIGHT DIFFERENTIAL-LEFT INPUT-SHAFT OUTPUT-SHAFT	H715343-99402 52400-99401 594A/592A HM813843/10 JLM714149/10
ARM 186			
	REAR AXLE REAR AXLE REAR AXLE REAR AXLE	PINION-HEAD PINION-TAIL DIFFERENTIAL-RIGHT DIFFERENTIAL-LEFT	H715334-9X021 9278-99401 64450-99401 JHM720249-X0251
MS16 [ARM 167]			
	REAR AXLE	PINION PAC-HEAD/TAIL	NP622975-907A5
MS17 [ARM177]			
	REAR AXLE REAR AXLE	PINION PAC-HEAD/TAIL DIFFERENTIAL-LEFT	NP804861-907A5 JHM720249-X0251
MAN			
F120/3 - [RATIO:5.57]			
	FORWARD AXLE FORWARD AXLE	PINION-TAIL PINION-HEAD	HM803149-99404 HM804843-99401
HY-13110 [RATIO 37:7/8/9/10/11/12]			
	FORWARD AXLE	DIFFERENTIAL-LEFT	32024X-9X064
VW 6,8 T [RATIO:4.44,39:7,4.87,5:570]			
	FORWARD AXLE	PINION-HEAD	JW5549-99403
RENAULT RVI			
569-10			
		DIFFERENTIAL-RIGHT DIFFERENTIAL-LEFT	JXC25763C-9X025 JXC25763C-9X025
669-01			
		PINION-TAIL PINION-HEAD	XBA32308B-90NA1 JW5049-90405
669-02			
		PINION-TAIL PINION-HEAD	XBA32308B-90NA1 JW5049-90405
669-04			
		PINION-TAIL PINION-HEAD	XBA32308B-90NA1 JW5049-90405
ARM 177			
	REAR AXLE REAR AXLE REAR AXLE	PINION PAC-HEAD/TAIL DIFFERENTIAL-RIGHT DIFFERENTIAL-LEFT	NP804861-907A5 NP331249-9X136 32021X-9X026





APPLICATION LISTINGS - FINAL DRIVE

		Application	
RENAULT RVI			
C9 HR			
		DIFFERENTIAL-RIGHT DIFFERENTIAL-LEFT	32019X-9X026 32021X-9X026
P1332-21			
		PINION-TAIL	HM813839-99402
P1332-22			
		PINION-TAIL	HM813839-99402
P1332-52			
		PINION-TAIL	HM813839-99402
P1332-54			
		PINION-TAIL	HM813839-99402
P1332-C			
		PINION-TAIL	HM813839-99402
P1332-E51			
		PINION-TAIL	HM813839-99402
P1332-C1			
		PINION-TAIL	HM813839-99402
PMA1341			
		PINION-TAIL	H715347-99402
PMA1341-02			
		PINION-TAIL	H715347-99402
PMA1841B			
		PINION-TAIL	H715347-99402
PMA1845B			
		PINION-TAIL	H715347-99402
		DIFFERENTIAL-RIGHT	33212-90KA1
		DIFFERENTIAL-LEFT	33212-90KA1
SOMA 95			
		PINION-TAIL	HM804842-99402
SCANIA			
RETARDER - GZ TRANSMISSION [GR900/905, GRS900/905]			
		MAIN-FRONT	JF4049-99403
RB652			
	FORWARD AXLE	INPUT-FRONT	JLM508748-99401
	FORWARD AXLE	INPUT-REAR	JLM508748-99401



B





APPLICATION LISTINGS - FINAL DRIVE





B

		Application	
SCANIA			
RBP830			
	FORWARD AXLE FORWARD AXLE FORWARD AXLE FORWARD AXLE	INPUT-FRONT INPUT-REAR OUTPUT-FRONT OUTPUT-REAR	JLM508748-99401 JLM508748-99401 JLM508748-99401 JLM508748-99401
RBP831			
	FORWARD AXLE FORWARD AXLE FORWARD AXLE FORWARD AXLE	INPUT-FRONT INPUT-REAR OUTPUT-FRONT OUTPUT-REAR	JLM508748-99401 JLM508748-99401 JLM508748-99401 JLM508748-99401
RP831			
		PINION-TAIL	H913842-9X021
RP830			
		PINION-TAIL	H913842-9X021
R780			
		PINION-TAIL	H913842-9X021
VOLVO			
EV21			
		DIFFERENTIAL-RIGHT DIFFERENTIAL-LEFT	33212-90KA1 33212-90KA1
EV35			
		PINION-TAIL PINION-HEAD	HM804843-99401 HM813840-99401
EV45			
		PINION-HEAD	HM911245-99401
EV71			
		DIFFERENTIAL-RIGHT	32017X-90KA1
EV72			
		DIFFERENTIAL-LEFT	32017X-90KA1
EV76			
		PINION-HEAD	H715332-99401
EV85B			
		PINION-TAIL PINION-HEAD	H913842-9X021 H913842-9X021
EV82FR			
		PINION-HEAD	H913842-9X021



APPLICATION LISTINGS - FINAL DRIVE



 		Application	
VOLVO			
MS15 [MT150]			
	FORWARD REAR	DIFFERENTIAL-RIGHT PINION PAC-HEAD/TAIL DIFFERENTIAL-RIGHT INPUT-SHAFT OUTPUT-SHAFT	NP331249-9X136 NP895655-90NA1 NP331249-9X136 LM104949/10 LM104949/10
MS17 [ARM 177]			
	REAR AXLE REAR AXLE REAR AXLE	PINION PAC-HEAD/TAIL DIFFERENTIAL-RIGHT DIFFERENTIAL-LEFT	NP804861-907A5 NP331249-9X136 32021X-9X026

PRODUCT INFORMATION

C

C

Product information

<i>Numerical Listings</i>	<i>p. C3</i>
<i>Dimensional Guide</i>	<i>p. C15</i>
<i>Cross-Reference Guide</i>	<i>p. C17</i>
<i>Fitting Instructions</i>	<i>p. C27</i>
<i>Bearing Damage Analysis</i>	<i>p. C31</i>
<i>Maintenance Tools</i>	<i>p. C35</i>

PRODUCT INFORMATION

C

NUMERICAL LISTINGS

C

368A/362A 50.80x88.90x20.64mm
IVECO

387A/382 57.15x98.43x21.00mm
IVECO

395A/394A 66.68x110.00x22.00mm
NISSAN

395S/394A 66.68x110.00x22.00mm
DAF

397XA/394XS 60.00x109.99x23.75mm
DODGE

455/453X 50.80x104.78x30.16mm
NISSAN

478XA/473XS 64.99x119.98x32.75mm
BEDFORD

482/472 69.85x120.00x29.79mm
BEDFORD

482A/472 69.85x120.00x29.79mm
BEDFORD

495/493 82.55x136.53x30.16mm
DAF

495A/493 76.20x136.53x30.16mm
FORD

497A-99401 85.73x133.35x30.16mm
DAF

527/522 44.45x101.60x34.93mm
DODGE
ERF
LEYLAND

528R/522 47.63x101.60x34.93mm
BEDFORD

537/532X 50.80x107.95x36.51mm
VOLVO

558/552A 60.33x123.83x38.10mm
BRISTOL
LEYLAND

560/552A 66.68x123.83x38.10mm
AWD
BEDFORD
NISSAN

566/563 69.85x127.00x36.51mm
BRISTOL

567/563 73.03x127.00x36.51mm
IVECO
RENAULT RVI

567X/563 73.03x127.00x36.51mm
DODGE
LEYLAND

575/572 76.20x139.99x36.51mm
BEDFORD
DENNIS
FODEN
SEDDON ATKINSON

575S/572 76.20x139.99x36.51mm
BEDFORD

578X/572 79.99x139.99x36.51mm
DODGE

580/572 82.55x139.99x36.51mm
AWD
BEDFORD
FODEN
FORD
LEYLAND
MERCEDES-BENZ
NISSAN
RENAULT RVI
SEDDON ATKINSON
VOLVO

580/572X 82.55x139.70x36.51mm
BEDFORD
BRISTOL
ERF
LEYLAND

582/572
VOLVO

594/592A 95.25x152.40x39.69mm
FORD
LEYLAND
SEDDON ATKINSON
VOLVO

594/593X 95.25x150.00x35.99mm
RENAULT RVI

594A/592A 95.25x152.40x39.69mm
BEDFORD
DENNIS
DODGE
ERF
FODEN
IVECO
LEYLAND
SEDDON ATKINSON

594A/592XS 95.25x147.64x35.72mm
DAF

598/592A 92.08x152.40x39.69mm
MERCEDES-BENZ

598A/592A 92.08x152.40x39.69mm
AWD
DAF
FODEN

NUMERICAL LISTINGS

598X/592A 92.08x152.40x39.69mm

LEYLAND

615/612 44.45x120.65x41.28mm

ERF
LEYLAND

623/612 57.15x120.65x41.28mm

BRISTOL
DENNIS

663/653 82.55x146.05x41.28mm

DAF
FODEN
SEDDON ATKINSON
VOLVO

665X/653X 85.00x150.00x41.28mm

RENAULT RVI

681A/672 92.08x168.28x41.28mm

DAF

683/672 95.25x168.28x41.28mm

BRISTOL
DAF
LEYLAND
RENAULT RVI
VOLVO

687/672 101.60x168.28x41.28mm

DAF

748S/742 76.20x150.09x44.45mm

LEYLAND

749A/742 82.55x150.09x44.45mm

DAF
VOLVO

759/752 88.90x161.93x47.63mm

LEYLAND

1380/1328 22.23x52.39x19.37mm

MERCEDES-BENZ

1988/1922 28.58x57.15x19.85mm

DODGE

2580/2520 31.75x66.42x25.40mm

BEDFORD

2788/2720 38.10x76.20x23.77mm

DODGE

2789/2720 39.69x76.20x23.77mm

MERCEDES-BENZ

3490/3420 38.10x79.38x29.37mm

BEDFORD
BRISTOL
DAF
DODGE
LEYLAND

3585/3525

41.28x87.31x30.16mm

DAF
DODGE
FORD
LEYLAND

3778/3720

47.63x93.26x30.16mm

DODGE

3780/3720

50.80x93.26x30.16mm

BEDFORD
BRISTOL
DODGE
FORD

3782/3720

44.45x93.26x30.16mm

DAF

3880/3820

41.28x85.73x30.16mm

NISSAN

3977-99401

60.00x112.71x30.16mm

DAF

3977X/3921XA

59.99x109.99x29.75mm

BEDFORD

3982/3920

63.50x112.71x30.16mm

DENNIS
LEYLAND

3984/3920

66.68x112.71x30.16mm

DAF
DODGE
FORD
IVECO
MERCEDES-BENZ

3994/JM511910

IVECO

5583/5535

60.33x122.24x43.66mm

DAF

6379/6320

65.09x135.76x53.98mm

ERF
LEYLAND

6379/6321

65.09x131.76x53.98mm

DAF

6386/6320

66.68x135.76x53.98mm

IVECO
VOLVO

6461A/6420

76.20x149.23x53.98mm

NISSAN

6581X/6535

90.00x161.93x53.98mm

IVECO

07087X/07210X

22.23x50.80x15.01mm

DAF

C

NUMERICAL LISTINGS

C

9278-99401 68.26x161.93x49.21mm
IVECO

9278-99402 68.26x161.93x49.21mm
DAF

18690/18620 46.04x79.38x17.46mm
DAF
IVECO

18790/18720 50.80x85.00x17.46mm
DAF
IVECO

25580/25520 44.45x82.93x23.81mm
DODGE

25590/25520 45.62x82.93x23.81mm
FORD
NISSAN

25877/25820 34.93x73.03x23.81mm
DODGE

27687/27620 82.55x125.41x25.40mm
DAF
NISSAN

28150/28300 38.10x76.20x20.64mm
IVECO

30205 25.00x52.00x16.25mm
NISSAN
RENAULT RVI

30206 30.00x62.00x17.25mm
NISSAN

30209 45.00x85.00x20.75mm
NISSAN

30210 50.00x90.00x21.75mm
NISSAN

30213 65.00x120.00x24.75mm
DODGE

30215 75.00x130.00x27.25mm
IVECO

30216 80.00x140.00x28.25mm
IVECO
KÄSSBOHRER

30218 90.00x160.00x32.50mm
IVECO
KÄSSBOHRER
MAN
NISSAN

30218M-90KM1 90.00x160.00x32.50mm
MAN

30220 100.00x180.00x37.00mm
MAN
MERCEDES-BENZ

30220M 100.00x180.00x37.00mm
MAN
MERCEDES-BENZ

30221 105.00x190.00x39.00mm
IVECO

30221M
TATRA

30305 25.00x62.00x18.25mm
DODGE
IVECO

30307 35.00x80.00x22.75mm
IVECO
SAF

30309 45.00x100.00x27.25mm
IVECO
SAF

30311 55.00x120.00x31.50mm
IVECO
SAF

30312 60.00x130.00x33.50mm
IVECO
SAF

30313 65.00x140.00x36.00mm
SAF

30314 70.00x150.00x38.00mm
MERCEDES-BENZ

32006X 30.00x55.00x17.00mm
CITROEN
IVECO
PEUGEOT

32008X 40.00x68.00x19.00mm
RENAULT RVI

32010X 50.00x80.00x20.00mm
IVECO
RENAULT RVI

32011X 55.00x90.00x23.00mm
IVECO
MERCEDES-BENZ
RENAULT RVI

32012X 60.00x95.00x23.00mm
DODGE
MERCEDES-BENZ
RENAULT RVI

32013X 65.00x100.00x23.00mm
RENAULT RVI

NUMERICAL LISTINGS

32014X 70.00x110.00x25.00mm

IVECO
MERCEDES-BENZ
RENAULT RVI

32015X 75.00x115.00x25.00mm

IVECO
MAN
RENAULT RVI

32016X 80.00x125.00x29.00mm

DAF
MERCEDES-BENZ

32017X 85.00x130.00x29.00mm

BEDFORD
IVECO
MAN
MERCEDES-BENZ
RENAULT RVI

32017X-90KA1 85.00x130.00x29.00mm

VOLVO

32018X 90.00x140.00x32.00mm

IVECO
MAN
MERCEDES-BENZ
RENAULT RVI

32019X 95.00x145.00x32.00mm

DAF
MAN
MERCEDES-BENZ
RENAULT RVI

32019X-9X026

RENAULT RVI

32020X 100.00x150.00x32.00mm

MERCEDES-BENZ

32021X 105.00x160.00x35.00mm

IVECO
KÄSSBOHRER-SETRA
MERCEDES-BENZ

32021X-9X026

RENAULT RVI
VOLVO

32022X 110.00x170.00x38.00mm

KÄSSBOHRER-SETRA

32024X 120.00x180.00x38.00mm

IVECO

32024X-9X064 120.00x180.00x38.00mm

MAN

32206 30.00x62.00x21.25mm

CITROEN
DAF
IVECO
MERCEDES-BENZ
PEUGEOT
RENAULT RVI
VOLVO

32206M

DAF

32207 35.00x72.00x24.25mm

MAN
MERCEDES-BENZ
RENAULT RVI
VOLVO

32208 40.00x80.00x24.75mm

GIGANT [SAE]
IVECO
MAN
MERCEDES-BENZ
RENAULT RVI
VOLVO

32209 45.00x85.00x24.75mm

LEYLAND
VOLVO

32210 50.00x90.00x24.75mm

GIGANT [SAE]
MAN
MERCEDES-BENZ
RENAULT RVI
VOLVO

32211 55.00x100.00x26.75mm

GIGANT [SAE]
IVECO
MERCEDES-BENZ
RENAULT RVI
VOLVO

32212 60.00x110.00x29.75mm

BEDFORD
GIGANT [SAE]

32213 65.00x120.00x32.75mm

SAF
SCHMITZ CARGOBULL

32214 70.00x125.00x33.25mm

GIGANT [SAE]
IVECO

32215 75.00x130.00x33.25mm

IVECO
MAN
MERCEDES-BENZ
SCANIA

C

NUMERICAL LISTINGS

32216 80.00x140.00x35.25mm

BEDFORD
GIGANT [SAE]
KÄSSBOHRER
MERCEDES-BENZ
SCANIA

32216-90KA1 80.00x140.00x35.25mm

MERCEDES-BENZ

32217 85.00x150.00x38.50mm

HINO
IVECO
MERCEDES-BENZ
MONTENEGRO
RENAULT RVI
SEDDON ATKINSON

32218 90.00x160.00x42.50mm

ARVINMERITOR [ROR]
BEDFORD
GIGANT [SAE]
HINO
KÄSSBOHRER
SAF
SCANIA
SEDDON ATKINSON

32219 95.00x170.00x45.50mm

BPW
IVECO
NISSAN
SCANIA
SEDDON ATKINSON
VOLVO

32220 100.00x180.00x49.00mm

ARVINMERITOR [ROR]
GIGANT [SAE]
IVECO

32221 105.00x190.00x53.00mm

IVECO
SAF

32222 110.00x200.00x56.00mm

BPW

32224 120.00x215.00x61.50mm

BPW

32304 20.00x52.00x22.25mm

MERCEDES-BENZ

32305 25.00x62.00x25.25mm

RENAULT RVI

32306 30.00x72.00x28.75mm

MERCEDES-BENZ

32306-9X025 30.00x72.00x28.75mm

MERCEDES-BENZ

32307 35.00x80.00x32.75mm

IVECO
NISSAN

32308 40.00x90.00x35.25mm

SCANIA
VOLVO

32309 45.00x100.00x38.25mm

DAF
IVECO
KÄSSBOHRER-SETRA
MAN
RENAULT RVI
SCANIA

32309B 45.00x100.00x38.25mm

DAF
RENAULT RVI

32310 50.00x110.00x42.25mm

BPW
DAF
GIGANT [SAE]
HINO
IVECO
MAN
MERCEDES-BENZ
NISSAN

32310A

SCHMITZ CARGOBULL

32311 55.00x120.00x45.50mm

DAF
IVECO
MERCEDES-BENZ
MERCEDES-BENZ DISCOS
SCANIA

32311A

SCHMITZ CARGOBULL

32312 60.00x130.00x48.50mm

IVECO
MERCEDES-BENZ
SAF
SCANIA
VOLVO

32313 65.00x140.00x51.00mm

HINO

32314 70.00x150.00x54.00mm

BPW
MERCEDES-BENZ
SAF

32316 80.00x170.00x61.50mm

BPW

32924 120.00x165.00x29.00mm

SAF

33011 55.00x90.00x27.00mm

MERCEDES-BENZ

33012 60.00x95.00x27.00mm

RENAULT RVI
VOLVO

C

NUMERICAL LISTINGS

33013 65.00x100.00x27.00mm

RENAULT RVI
VOLVO

33014 70.00x110.00x31.00mm

MERCEDES-BENZ
RENAULT RVI
VOLVO

33015 75.00x115.00x31.00mm

MAN
MERCEDES-BENZ
NISSAN
RENAULT RVI
VOLVO

33017 85.00x130.00x36.00mm

MERCEDES-BENZ

33018 90.00x140.00x39.00mm

RENAULT RVI
VOLVO

33019 95.00x145.00x39.00mm

BEDFORD
DAF
IVECO
MAN
MERCEDES-BENZ
SEDDON ATKINSON

33019-90KA1 95.00x145.00x39.00mm

IVECO
MAN
MERCEDES-BENZ

33020 100.00x150.00x39.00mm

MERCEDES-BENZ
SCHMITZ CARGOBULL

33021 105.00x160.00x43.00mm

IVECO
MAN
MERCEDES-BENZ

33022 110.00x170.00x47.00mm

MAN
MERCEDES-BENZ
VOLVO

33022-9X026 110.00x180.00x47.00mm

MAN
MERCEDES-BENZ

33024 120.00x180.00x48.00mm

GIGANT [SAE]

33108 40.00x75.00x26.00mm

RENAULT RVI

33109 45.00x80.00x26.00mm

MERCEDES-BENZ
RENAULT RVI

33111 55.00x95.00x30.00mm

IVECO
MERCEDES-BENZ

33111-90KA1 55.00x95.00x30.00mm

MERCEDES-BENZ

33112 60.00x100.00x30.00mm

MERCEDES-BENZ

33113 65.00x110.00x34.00mm

IVECO
MERCEDES-BENZ
SAF

33115 75.00x125.00x37.00mm

MAN
NISSAN
VOLVO

33116 80.00x130.00x37.00mm

BPW
GIGANT [SAE]
MERCEDES-BENZ
SCHMITZ CARGOBULL

33117 85.00x140.00x41.00mm

MERCEDES-BENZ
RENAULT RVI

33118 90.00x150.00x45.00mm

BPW
GIGANT [SAE]
IVECO
SCHMITZ CARGOBULL

33205 25.00x52.00x22.00mm

MERCEDES-BENZ
RENAULT RVI

33206 30.00x62.00x25.00mm

IVECO
MAN
RENAULT RVI

33207 35.00x72.00x28.00mm

IVECO
RENAULT RVI
SAF
VOLVO

33208 40.00x80.00x32.00mm

GIGANT [SAE]
IVECO
MERCEDES-BENZ
RENAULT RVI
VOLVO

33208-90KA1 40.00x80.00x32.00mm

MERCEDES-BENZ

33208-9TKA1 40.00x80.00x32.00mm

MERCEDES-BENZ

NUMERICAL LISTINGS

33209 45.00x85.00x32.00mm

DAF
IVECO
LEYLAND
MAN
MERCEDES-BENZ
RENAULT RVI
SAF

33209-90KA1 45.00x85.00x32.00mm

MAN
MERCEDES-BENZ

33210 50.00x90.00x32.00mm

DAF
MAN
MERCEDES-BENZ
RENAULT RVI

33211 55.00x100.00x35.00mm

IVECO
MERCEDES-BENZ
RENAULT RVI
SAF

33212 60.00x110.00x38.00mm

IVECO
RENAULT RVI
SAF

33212-90KA1 60.00x110.00x29.75mm

RENAULT RVI
VOLVO

33213 65.00x120.00x41.00mm

ARVINMERITOR [ROR]
BEDFORD
BPW
GIGANT [SAE]
IVECO
MERCEDES-BENZ
RENAULT RVI
SAF
SCHMITZ CARGOBULL
VOLVO
YORK

33214 70.00x125.00x41.00mm

MERCEDES-BENZ
RENAULT RVI

33215 75.00x130.00x41.00mm

BPW
MERCEDES-BENZ
SCANIA

33216 80.00x140.00x46.00mm

RENAULT RVI

33217 85.00x150.00x49.00mm

IVECO
MERCEDES-BENZ DISCOS
SCHMITZ CARGOBULL
VOLVO

33217-90KA1 85.00x150.00x49.00mm

MERCEDES-BENZ

33287/33462 73.03x117.48x30.16mm

DENNIS
FORD

33310

MERCEDES-BENZ

33895/33822 53.98x95.25x27.78mm

MERCEDES-BENZ

34306-99401 77.79x121.44x24.61mm

IVECO

39580/39520 57.15x112.71x30.16mm

VOLVO

39581

DAF

39581/39520 57.15x112.71x30.16mm

BEDFORD
DAF
DODGE
FORD
LEYLAND

39586/39528 64.99x119.99x32.75mm

MERCEDES-BENZ

39590/39520 66.68x112.71x30.16mm

FORD
MAN
VOLVO

42686/42624 74.99x129.98x33.25mm

BEDFORD

42687/42620

VOLVO

45291/45220 57.15x104.78x30.16mm

DAF

47487/47420 69.85x120.00x32.55mm

IVECO

47490/47420 71.44x120.00x32.55mm

MERCEDES-BENZ

47678/47620 76.20x133.35x33.34mm

VOLVO

47686/47620 82.55x133.35x33.34mm

FORD

47687/47620 82.55x133.35x33.34mm

DAF

47687-99401 82.55x133.35x33.34mm

DAF

C

NUMERICAL LISTINGS

48290 127.00mm
TATRA

48393/48320 136.53x190.50x39.69mm
DAF

49175/49368 44.45x93.66x31.75mm
BRISTOL

52375/52618 95.25x157.16x36.51mm
RENAULT RVI

52400/52618 101.60x157.16x36.51mm
FODEN
LEYLAND

52400-99401 101.60x157.16x36.51mm
IVECO

52401/52618 101.60x157.16x36.51mm
ERF

52401-99401 101.60x157.16x36.51mm
DAF

55206C-99404 53.39x111.13x30.16mm
IVECO

56426/56650 107.95x165.10x36.51mm
ERF

64432/64708 109.98x177.80x41.28mm
RENAULT RVI

64450-99401 114.30x177.80x41.28mm
IVECO

74550/74850 139.70x215.90x47.63mm
FODEN

78214-99401 53.98x140.03x36.51mm
DAF

78225-99401 57.15x140.03x36.51mm
DAF

EK50001

DAF
MAN

EK50005

VOLVO

EK50011

KÄSSBOHRER-SETRA
MERCEDES-BENZ

EK50020

DAF

EK50021

DAF
MAN
MERCEDES-BENZ

EK50022

DAF

EK50024

MAN

EK50029

MERCEDES-BENZ

EK50031

MAN
MERCEDES-BENZ

EK50036

MERCEDES-BENZ

EK50037

MERCEDES-BENZ

EK50042

RENAULT RVI

EK50044

VOLVO

EK50045

ARVINMERITOR [ROR]

EK50046

ARVINMERITOR [ROR]

EK50050

FRUEHAUF
SMB

EK50338

MERCEDES-BENZ

H212749/10 65.99x124.00x41.50mm

BRISTOL
DAF
ERF
FODEN
SEDDON ATKINSON
YORK

H414242/10 66.68x136.53x41.28mm

DODGE
LEYLAND

H414245X/10 68.26x136.53x41.28mm

BEDFORD
BRISTOL
NISSAN

H414249/10 71.44x136.53x41.28mm

ERF

H715332-99401 60.33x136.53x46.04mm

DAF
VOLVO

H715334-9X021 61.91x136.53x46.04mm

IVECO

NUMERICAL LISTINGS

C

H715343-99402 68.26x136.53x46.04mm
IVECO

H715347-99402 69.99x136.53x46.04mm
RENAULT RVI

H913842-9X021 61.91x146.05x41.28mm
SCANIA
VOLVO

HM204049/10 45.99x91.00x32.00mm
ERF
FODEN
SEDDON ATKINSON

HM212044/10 60.33x122.24x38.10mm
NISSAN

HM212044/11 60.33x122.33x38.10mm
FODEN
LEYLAND
VOLVO

HM212047/11 63.50x122.24x38.10mm
SEDDON ATKINSON
DODGE

HM212049/10 66.68x122.24x38.10mm
IVECO

HM212749/10 65.99x124.00x41.50mm
DODGE
LEYLAND

HM215249/10 75.99x132.00x39.00mm
FODEN
FORD
LEYLAND
SAF
VOLVO

HM218248/10 89.98x146.98x40.00mm
ARVINMERITOR [ROR]
BRISTOL
DODGE
LEYLAND
RENAULT RVI
SAF
SCHMITZ CARGOBULL
YORK

HM218248Z/10 89.98x146.98x40.00mm
SCANIA
VOLVO

HM220149/10 99.98x156.98x42.00mm
DODGE
IVECO
LEYLAND
MERCEDES-BENZ
SEDDON ATKINSON
YORK

HM220149Z/10 99.98x156.98x42.00mm
SCANIA
VOLVO

HM515745/16 76.20x142.14x44.45mm
DODGE

HM515745/1616
DODGE

HM518445/10 88.90x152.40x39.69mm
FRUEHAUF
MONTENEGRO

HM801346X/10 38.10x82.55x29.37mm
DENNIS

HM803149-99404 44.45x88.90x30.16mm
IVECO
MAN

HM804842-99402 44.45x95.25x30.16mm
RENAULT RVI

HM804843-99401 44.45x95.25x30.16mm
MAN
VOLVO

HM804846-99401 47.63x95.25x30.16mm
IVECO

HM804848-99401 48.41x95.25x30.16mm
IVECO

HM813839-99402 59.99x127.00x36.51mm
RENAULT RVI

HM813840-99401 55.56x127.00x36.51mm
VOLVO

HM813843/10
IVECO

HM911245-99401
VOLVO

JF4049-99403 40.00x85.00x33.00mm
SCANIA

JF6049/10 40.00x85.00x33.00mm
SCANIA

JF7049A/10 70.00x130.00x43.00mm
SCANIA
VOLVO

JF9549/10 95.00x160.00x46.00mm
RENAULT RVI

JH211749/10 65.00x120.00x39.00mm
RENAULT RVI
SAURER

NUMERICAL LISTINGS

JH415647/10 75.00x145.00x51.00mm

IVECO
MERCEDES-BENZ

JHM522649/10 110.00x180.00x47.00mm

SAURER

JHM720249/10 100.00x160.00x41.00mm

RENAULT RVI
TATRA

JHM720249-X0251

IVECO

JLM508748-99401 60.00x95.00x24.00mm

SCANIA

JLM714149/10

IVECO

JLM714149P/110P 75.00x115.00x25.00mm

RENAULT RVI

JM20749A

DAF

JM205149/10 50.00x90.00x28.00mm

BRISTOL
FODEN
SAURER
VOLVO

JM207049/10 55.00x95.00x29.00mm

VOLVO

JM511946/10 65.00x110.00x28.00mm

DAF
LEYLAND
RENAULT RVI

JM515649/10 80.00x130.00x35.00mm

TRAILOR

JM714249/10 75.00x120.00x31.00mm

DAF
IVECO
LEYLAND
MERCEDES-BENZ

JM716649/10 85.00x130.00x30.00mm

SEDDON ATKINSON

JM716649-99401 85.00x130.00x30.00mm

IVECO

JM718149A/10 90.00x145.00x35.00mm

TRAILOR

JM822049/10 110.00x165.00x35.00mm

SAURER

JT9049/10 90.00x150.00x42.00mm

RENAULT RVI

JW5049-90405 50.00x105.00x32.00mm

IVECO
RENAULT RVI

JW5549-99403 55.00x115.00x34.00mm

MAN

JXC15349CA/DA

IVECO

JXC17349CA/DA

IVECO

JXC18439CA/DA 45.00x85.00x32.00mm

IVECO

JXC25370CA/DA 45.00x75.00x20.00mm

IVECO

JXC25381CD-90UB6

ALEXANDER DENNIS

JXC25381CH/DC 70.00x130.00x43.00mm

IVECO

JXC25389CC/9DA

IVECO

JXC25389CC/DA 55.00x100.00x35.00mm

IVECO

JXC25678CA 55.00mm

PEUGEOT

JXC25678CA-90KA1 55.00x90.00x23.00mm

CITROEN
IVECO

JXC25716C/D 75.00x115.00x25.00mm

IVECO

JXC25716C-90401 75.00x115.00x25.00mm

IVECO

JXC25723CH/DD 70.00x120.00x37.00mm

IVECO

JXC25763C-9X025 70.00x120.00x37.00mm

RENAULT RVI

L68149/10 34.99x59.13x15.88mm

DAF

LM48548/10 34.93x65.09x18.03mm

FORD

LM67048/10 31.75x59.13x15.88mm

NISSAN

LM104949/10

VOLVO

NP569484/644537

ARVINMERITOR [ROR]

NUMERICAL LISTINGS

NP078914-90UA1 68.00x127.00x115.00mm

SCANIA

NP80461-907A5

IVECO
RENAULT RVI
VOLVO

NP240581-90UA1 82.00x140.00x110.00mm

BREDAMENARINIBUS
IVECO

NP318274 90.00mm

DENNIS

NP318274-90UA7 90.00x160.00x125.00mm

IVECO

NP331249-9X136 101.60x160.00x35.00mm

RENAULT RVI
VOLVO

NP622975-907A5

IVECO

NP694163-90UA4 90.00x160.00x125.00mm

IRISBUS

NP793154-90UA2 78.00x130.00x90.00mm

DAF

NP793154-90UA3 78.00x130.00x90.00mm

IVECO

NP895655-90NA1

VOLVO

NP958644-9X048 35.00x62.00x18.00mm

FORD

U497/U460L 44.99x79.98x24.00mm

DAF

XAA32008X 40.00mm

CITROEN
IVECO
PEUGEOT

XAA32010X 50.00mm

CITROEN
IVECO
PEUGEOT

XAA32011XM-90NM5 55.00x90.00x70.00mm

FORD

XAA32018X-90KA1 90.00x140.00x32.00mm

DAF

XAA32217/Y32217 85.00x150.00x38.50mm

IVECO

XAA32219/Y32219 95.00x170.00x45.50mm

IVECO

XAA33108 40.00mm

CITROEN
IVECO

XAA33108/Y33108 40.00x75.00x26.00mm

PEUGEOT

XAA33212/Y33212 60.00x110.00x38.00mm

IVECO

XBA32308B-90NA1 40.00x90.00x35.25mm

RENAULT RVI

XC2379CD/DA 77.79x121.44x24.61mm

IVECO

XC8640/HM220110

SCANIA

XGA32021X/Y32021X 106.00x160.00x35.00mm

MAN
MERCEDES-BENZ

XGA32021X-90KA1 106.00x160.00x35.00mm

MERCEDES-BENZ

C



NOTES



Lined area for notes with horizontal orange lines.



DIMENSIONAL GUIDE

Ø	Ø	width	REF
INT.	EXT.		
75.00	115.00	25.00	32015X
75.00	115.00	25.00	JLM714149-99401
75.00	115.00	25.00	JLM714149P/110P
75.00	115.00	25.00	JXC25716C/D
75.00	115.00	25.00	JXC25716C-90401
75.00	115.00	31.00	33015
75.00	115.00	31.00	33015
75.00	120.00	31.00	JM714249/10
75.00	125.00	37.00	33115
75.00	130.00	27.25	30215
75.00	130.00	33.25	32215
75.00	130.00	41.00	33215
75.00	145.00	51.00	JH415647/10
75.99	132.00	39.00	HM215249/10
76.20	133.35	33.34	47678/47620
76.20	136.53	30.16	495A/493
76.20	139.99	36.51	575/572
76.20	139.99	36.51	575S/572
76.20	142.14	44.45	HM515745/16
76.20	149.23	53.98	6461A/6420
76.20	150.09	44.45	748S/742
77.79	121.44	24.61	34306-99401
77.79	121.44	24.61	XC2379CD/DA
78.00	130.00	90.00	NP793154-90UA2
78.00	130.00	90.00	NP793154-90UA3
79.99	139.99	36.51	578X/572
80.00	125.00	29.00	32016X
80.00	130.00	35.00	JM515649/10
80.00	130.00	37.00	33116
80.00	140.00	28.25	30216
80.00	140.00	35.25	32216
80.00	140.00	35.25	32216-90KA1
80.00	140.00	45.99	33216
80.00	170.00	61.50	32316
82.00	140.00	36.51	NP569484/644537
82.00	140.00	110.00	NP240581-90UA1
82.55	125.41	25.40	27687/27620
82.55	133.35	33.34	47686/47620
82.55	133.35	33.34	47687/47620
82.55	133.35	33.34	47687-99401
82.55	136.53	30.16	495/493
82.55	139.70	36.51	580/572X
82.55	139.99	36.51	580/572
82.55	146.05	41.28	663/653
82.55	150.09	44.45	749A/742
85.00	130.00	29.00	32017X
85.00	130.00	29.00	32017X-90KA1
85.00	130.00	30.00	JM716649/10
85.00	130.00	30.00	JM716649-99401
85.00	130.00	36.00	33017
85.00	140.00	41.00	33117
85.00	150.00	38.50	32217
85.00	150.00	38.50	XAA32217/Y32217
85.00	150.00	41.28	665X/653X
85.00	150.00	49.00	33217
85.00	150.00	49.00	33217-90KA1
85.73	133.35	30.16	497A-99401
88.90	152.40	39.69	HM518445/10
88.90	161.93	47.63	759/752
89.98	146.98	40.00	HM218248/10
89.98	146.98	40.00	HM218248Z/10
90.00			NP318274
90.00	140.00	32.00	32018X

Ø	Ø	width	REF
INT.	EXT.		
90.00	140.00	32.00	XAA32018X-90KA1
90.00	140.00	39.00	33018
90.00	145.00	35.00	JM718149A/10
90.00	150.00	42.00	JT9049/10
90.00	150.00	45.00	33118
90.00	160.00	32.50	30218
90.00	160.00	32.50	30218M-90KM1
90.00	160.00	42.50	32218
90.00	160.00	125.00	NP318274-90UA4
90.00	160.00	125.00	NP318274-90UA7
90.00	160.00	125.00	NP694163-90UA4
90.00	161.93	53.98	6581X/6535
92.08	152.40	39.69	598/592A
92.08	152.40	39.69	598A/592A
92.08	152.40	39.69	598X/592A
92.08	168.28	41.28	681A/672
95.00	145.00	32.00	32019X
95.00	145.00	39.00	33019
95.00	145.00	39.00	33019-90KA1
95.00	160.00	46.00	JF9549/10
95.00	170.00	45.50	32219
95.00	170.00	45.50	XAA32219/Y32219
95.25	147.64	35.72	594A/592XS
95.25	150.00	35.99	594/593X
95.25	152.40	39.69	594/592A
95.25	152.40	39.69	594A/592A
95.25	152.40	39.69	594A-99401
95.25	157.16	36.51	52375/52618
95.25	168.28	41.28	683/672
99.98	156.98	42.00	HM220149/10
99.98	156.98	42.00	HM220149Z/10
99.98	156.98	42.00	XC8640CD/ HM220110
100.00	150.00	32.00	32020X
100.00	150.00	39.00	33020
100.00	160.00	41.00	JHM720249/10
100.00	160.00	41.00	JHM720249-9X026
100.00	180.00	37.00	30220
100.00	180.00	37.00	30220M
100.00	180.00	49.00	32220
101.60	157.16	36.51	52400/52618
101.60	157.16	36.51	52400-99401
101.60	157.16	36.51	52401/52618
101.60	157.16	36.51	52401-99401
101.60	160.00	35.00	NP331249-9X136
101.60	168.28	41.28	687/672
105.00	160.00	35.00	32021X
105.00	160.00	43.00	33021
105.00	190.00	39.00	30221
105.00	190.00	53.00	32221
106.00	160.00	35.00	XGA32021X/ Y32021X
106.00	160.00	35.00	XGA32021X-90KA1
107.95	165.10	36.51	56426/56650
109.98	177.80	41.28	64432/64708
110.00	165.00	35.00	JM822049/10
110.00	170.00	38.00	32022X
110.00	170.00	47.00	33022
110.00	180.00	47.00	33022-9X026
110.00	180.00	47.00	JHM522649/10
110.00	200.00	56.00	32222
114.30	177.80	41.28	64450-99401
120.00	165.00	29.00	32924

Ø	Ø	width	REF
INT.	EXT.		
120.00	180.00	38.00	32024X
120.00	180.00	38.00	32024X-9X064
120.00	180.00	48.00	33024
120.00	215.00	61.50	32224
127.00			48290
136.53	190.50	39.69	48393/48320
139.70	215.90	47.63	74550/74850
			EK50001
			EK50011
			EK50020
			EK50021
			EK50022
			EK50024
			EK50029
			EK50031
			EK50036
			EK50042
			EK50045
			EK50046
			EK50050
			EK50338

CROSS REFERENCE GUIDE

ARVINMERITOR

99041022	663/653
99041025	641/632
99041034	665A/653
99041035B	HM218248/10
99041035S	HM218248/10
99041045B	33213
99041045S	33213
99041057	32218
99041058	32220
99041067	EK50045
99041067B	33116
99041068	EK50046
99041068B	EK50046
99041075	NP569484/644537
99041076	NP727209/106970
99049413	HM212044/11
A1228A599	H715334/11
A1228G605.M	72212C/72487
A1228Q1317	580/572
A1228Q1499	NP240581
A1228R1006	JM716648/10
A1228R642	34306/478
A1228S1033.M	65237/65500
A1228V594.M	9278/9220
A1228X1480	NP318274
A1228Z650	HM813843/10
A11228A1535	NP553050/JW7010
A11228B1666	NP707669/H914811
A11228L636	3920

B.P.W.

02.6401.20.00	30204
02.6401.25.00	30205
02.6401.30.00	30206
02.6401.35.00	30207
02.6401.45.00	30209
02.6401.50.00	30210
02.6401.60.00	30212
02.6404.35.00	32007X
02.6405.60.00	32212
02.6405.95.00	32219
02.6406.45.00	32309
02.6406.50.00	32310
02.6406.70.00	32314
02.6407.45.00	33209
02.6407.65.00	33213
02.6407.75.00	33215
02.6407.85.00	33217
02.6408.29.00	33215
02.6408.80.00	33116
02.6408.90.00	33118
02.6410.22.00	33213
02.6410.23.00	33118
02.6410.24.00	33116
02.6410.25.00	32310
02.6410.26.00	32222
02.6410.28.00	32219
09.02.6407.65.00	HM218248/10

BEDFORD

410707	32218
1041617	3977X/3921XA
2690284	575/572
2702062	594A/592A
6311391	42686/42624
6311750	575S/572
6314106	482A/472
6371978	594/592A
7058557	395S/394A
7088587	3490/3420
7119513	2580/2520
7132203	580/572
7133236	495A/493
7139286	478XA/473XS

BEDFORD...

7174004	39581/39520
7174007	3490/3420
7181959	3780/3720
7182008	H414245X/10
8824111	LM67048/10
8845471	18790/18720
8845472	18690/18620
8849611	528R/522
11054489	LM11749/10
BT7084095	30206

BMC

7M52913	30205M
---------	--------

BRISTOL

10871003/4	683/672
10902762/63	H212749/10
10902764/65	JM205149/10
B71092	JM716649/10
B71093	JM714249/10

DAF

13H6552	JM511946/10
77060	32018X
140896	32309
174589	598A/592A
174592	663/653
174595	681A/672
174597	683/672
202824	39581/39520
202825	3585/3525
221664	XAA33115
254912	JM714249/10
260204	EK50001
260724	687/672
260725	48393/48320
266488	NP323058
275823	32311
275828	XAA32311
283684	32309
283686	32309
325333	47678/47620
325402	3782/3720
325405	5583/5535
491899	32206M
491966	3490/3420
494535	18690/18620
495520	45291/45220
541123	6379/6321
542137	27687/27620
556289	32310
556290	NP972022-92KA1
575168	594A/592XS
614943	33210
622102	JM716649/10
626875	32310
631442	33018
636819	XAA33212
636820	33209
640618	32016X
655407	32019X
676987	33019
676988	EK50020
682375	681A/672
692180	EK50046
699117	32020X
1400081	JM207049A/10
10271961	495/493
10890343	3984/3920
10901093	JM714249/10

DAF...

10901094	H212749/10
RTC3412	18690/18620
RTC3427	L68149/10
UKC4805	07087X/07210X

E R F

49666	39590/39520
SL84/107	567X/563
SL84/115	HM515745/16
SL84/116	594A/592A
SL84/171	623/612
SL84/217	33287/33462
SL84/220	580/572X
SL84/283	594A/592A
SL84/298	56426/56650
SL84/315	HM204049/10
SL84/316	H212749/10
SL84/72	615/612
SL84/73	6379/6320

EVOBUS

9805002	1380/1328
9805402	1380/1328
9805502	1380/1328
9806802	33895/33822
9807202	47490/47420
9807402	47490/47420
9807502	33111
9808202	LM503349A/10
9808302	JM207049/10
9809602	33019
9809702	33021
9810205	30216
9810305	32216
9812005	32310
9812105	32219
9812205	32217
9812401	32216
9813305	32211
9813605	32210
9814518	33113
9815605	580/572
9815705	47487/47420
9816105	497/492A
9817205	32216
9817405	32215
9817505	598/592A
9817905	598/592A
9818302	33111
9818405	32215
9818905	30312
9819002	32011XM
9819005	32211
9819405	32216
9819505	32306
9819605	32307
19801002	33214
19802502	XGA32021X/Y32021X
19802602	32019X
19802702	33215
19802902	LM48548/10
19806202	LM501349/10
19806602	33020
19806702	33117
19810405	3984/3920
19810505	33895/33822
19811405	497/492A
19811505	32206M
19812905	32310
19813705	30309
19813805	33895/33822
19813905	3984/3920
19814505	598X/592A
19814805	32215

CROSS REFERENCE GUIDE

EVOBUS...

19815605
19816105
19816205
19816405
19816505
19816505
19817005
19817205
19817405
19817605
19818202
19818305
19818405
19818505
19818605
19818705
19818905
19819005
19819505
19819705
29810005
29810605
29811205
29811305
29811605
29811705
29811805
29811905
29812005
29812205
29812405
29812805
29815005
29815405
29816605
29817905
29818205
29818605
29818905
29819005
29819202
29819305
39811005
39811105
39811505
39811605
39812505
39812605
39812705
39812805
39813205
39813705
39813905
39814105
39814305
39814705
39815105
39815205
39815305
39815605
39815705
39816405
39817205
39817405
39818305
39818505
39818605
39819505
39819605
49810705
49810905
49811305
49811705
49812105
49813405
49813805
49814205
49814605

32307
32206M
30211
32020X
30206
32206M
32307
32020X
32310
32310
32310
32310
32306
32211
30216
32211
32306
32210
32304
32306
30312
580/572
3984/3920
32010X
32011XM
47487/47420
32217
32217
32210
32304
32210
32211
59819805
2789/2720
32022X
32019X
32011XM
33210
33111
33215
33215
33019
47490/47420
33011
33205
33109
33205
33109
32021X
33021
32021X
33021
33115
33213
33208
33113
33011
JM714249/10
32019X
33214
33209
33214
33209
32307
33208
33213
33214
33019
33205
33109
33022
33022
32309
32018X
30220M
EK50029
EK50029
33210
580/572

EVOBUS...

49814705
49814805
49814905
49816405
49816505
49816705
49816805
49817205
49817305
49817405
49819805
49819905
59810005
59812105
59812205
59813105
59814005
59814105
59814405
59814905
59815305
59815605
59816605
59816905
59818305
59818405
59818505
59818605
59819005
59819505
59819805
59819905
69810105
69810605
69810705
69810805
69814705
69815205
69815605
69815905
69816905
69817005
69817405
69818205
69819905
79810405
79814505
79815705
79817605
79819005
89817505
99810805
99814105
99814305
99818105
99819305
109819305
119816805
119816905
129814005
129819205
129819705
139813905
139814205
159817505
720032013
720032014
720032016
720032018
720032206
720032211
720032216
720032306
720032307
1249810305
1409810005
3129810501
3199810205
3199810405

580/572
580/572
30220M
33211
33211
33211
33208
33209
32214
32020X
32314
32314
32314
33022
33205
EK50011
33210
33209
33011
33021
32210
32018X
32014X
33014
33117
33020
33020
33117
32022X
32014X
32014X
33117
33020
32216
32307
32311
32019X
33214
32011XM
32306
32311
33013
32311
33111
32310
32011XM
32008X
33011
32206M
32016X
33208
EK50031
32010X
HM220149/10
JH415647/10
33011
32311
32312
32312
33116
30312
30210
EK50031
EK50031
32312
32013X
32014X
32016X
32018X
32206M
32211
32216
32306
32307
1380/1328
33205
32306
32211
32210

EVOBUS...

3199810605
3279810305
3279810405
3279812205
6319810005
72003202480

32304
32215
32217
32217
30209
32024X

FODEN

FL110/17
FL110/18
FL110/29
FL110/30
FL110/31
FL110/33

52400/52618
663/653
HM215249/10
JM205149/10
39590/39520
JHM522649/10

FORD

A790X 1200BA
TAJAA 1238 A

39581/39520
580/572

FRUEHAUF

AJA0813.001
M003168

HM518445/10
EK50050

GIGANT

10500474
10500496
10500505
10500558
10500572
10500574
10500582
10500787
10500799
10500858
10500859
10500872
10500873
M003168

32208
32210
32220
33213
33116
33117
33118
32224
33208
33215
32219
32222
32314
EK50050

IVECO

354821
521125
521194
521195
564707
626153
634049
712166
819015
914220
1101597
1102042
1102857
1102858
1102859
1102860
1102864
1103141
1103142
1103228
1103360
1103771
1104922
1104923
1109968
1109981

567/563
3780/3720
3984/3920
3780/3720
32218
33215
387A/382A
33216
30211
33217
32011X
32015X
30215
30218
30312
32024X
30221
32015X
32214
32018X
32024X
32215
32021X
33019
30217
30309

CROSS REFERENCE GUIDE

RENAULT RVI...

23356131
23431209
23431210
23431211
23432213
23432218
23432307
23874099
23874324
773021100
773030900
773220800
773220800
773220900
773221500
773230500
773230700
959032210
0959130220M
959232206
0959232206M
959232207
959232208
959232208
959232209
959232211
959232214
959232215
959232217
959232218
959232219
959232220
959443021
959532207
959532212
959532216
959532218
959532309
959532310
959532311
959532312
959532313
959532314
959901065
959901082
959901092
959901208
959902085
959904216
5000020631
5000021842
5000021895
5000254793
5000350020
5000350029
5000350189
5000350270
5000388284
5000389250
5000391585
5000392236
5000392237
5000434273
5000437785
5000437786
5000437791
5000442185
5000442186
5000442189
5000443519
5000470672
5000470673
5000470861
5000470862
5000546524
5000598486
5000609898
5000609900
5000669957

33209
30209
30210
30211
32213
32218
32307
42687/42620
47686/47620
30211
30309
32208
32208M
32209
32215
32305
32307
32210
30220M
32206M
32207
32208
32208M
32209
32211
32214
32215
32217
32218
32219
32220
33021
32207M
32212
32216
32218
32309
32310
32311
32312
32313
32314
6379/6320
580/572
598/592A
3984/3920
665X/653X
594/593X
30221
32218
32022X
32018X
33018
33015
33013
33012
32207
32011XM
32010X
32010X
32011XM
33209
33209
33213
33213
33210
33210
33210
33211
33210
33214
33210
33214
33208
33211
33214
30216
33210

RENAULT RVI...

5000671939
5000673467
5000675133
5000675250
5000675627
5000682543
5000682544
5000682662
5000682886
5000685691
5000685835
5000685836
5000685837
5000685838
5000685839
5000685959
5000690018
5000785895
5000785898
5000785909
5000785910
5000786292
5000786298
5000788406
5000788712
5000873122
5001014916
5003090068
5003090069
5003090900
5003090901
5003090902
5010067672
5010136663
5010136759
5010136762
5010136766
5010136767
5010136769
5010241096
5010241918
5010368899
5010368900
5010439054
5010439055
5010439057
5010439061
5010439064
5010439065
5010439224
5010439301
5010439570
5010439571
5010443768
5010443903
5010587007
5010587008
5010587009
5010587010
5516010033
5516010506
5516010507
5516010573
5516010573
5516010574
5516010587
5516011446
5516014042
5516014518
5516014518
5516014519
5516014554
5516014554
5516015839
5516016467
5516016468
5516016469
5516016470
5516016470

JM716649/10
33207
32019X
33117
33216
32220
JHM522649/10
32019X
JM718149A/10
32013X
33012
33013
33014
33015
33018
32012X
33207
JF9549/10
33216
33216
JF9549/10
32016X
33211
33115
33207
33213
32022X
33206
33209
33209
33206
33108
33213
33214
33108
33208
33206
33209
33213
32019X
32207M
33213
33213
33206
33207
33210
33211
33214
33213
32019X
32019X
32018X
33117
JF9549/10
JLM714149P/10P
32017X
33117
33216
JT9049/10
JF9549/10
33012
32206M
32210
32207
32207M
32211
33209
33013
32208
32208M
32211
32208
32208M
33014
32209
32209
32209
32206
32206M

RENAULT RVI...

5516016471
5516016472
5516016472
5516016784
5516016786
5516016788
7701014445
7703090034
7703090085
7703090098

32209
32206
32206M
33012
33012
33014
42687/42620
32008X
32206M
30205

SAF

4200000300
4200001100
4200001100
4200001200
4200001300
4200001400
4200001500
4200001600
4200002200
4200002300
4200002500
4200002600
4200002700
4200002800
4200003100
4200003200
4200003300
4200003400
4200005500
4200005700
4200005800
4200006000
4200006300
4200006400
4200007000
4200100600
4200100700
4200100900
4200101000

30206
30307
32206
30309
30310
30311
30312
30313
32209
32213
32217
32219
32218
32221
32309
32311
32312
32314
33113
33207
33211
33213
33209
33212
33215
HM218248/10
HM215249/10
33118
32924M

SAURER

8102
81361
81363
81560
82260
82261
16080640
16380640
8064000810
8064000813
8064000822

JM205149/10
JM511946/10
JH211749/10
JM714249/10
JM822049/10
JHM522649/10
JM205149/10
JH211749/10
JM205149/10
JM511946/10
JM822049/10

SCANIA

14102
14103
14146
14611
14614
14623
14698
14735
14736
14764
14835
14836
33948
77192
123263

32215
32216
32217
30216
32306
32309
32308
32310
32313
32311
32218
32312
32219
32307
30314

CROSS REFERENCE GUIDE

SCANIA...

123631	32206
123631	32206M
143746	52400/52618
174717	30217
177801	30307
177802	30309
177892	32213
177893	32215
178427	32311
202635	32207
214104	32208
214104	32208M
214478	395A/394A
234171	JM716649/10
244347	JLM508748/10
260998	33215
264700	H9138427/10
264960	32022X
264961	33017
272716	HM220149Z/10
274114	32020X
284843	33208
284992	482/472
315288	33206
317350	JM205149/10
322748	JF7049A/10
326826	32016X
345835	33212
351715	32022X
362226	32022X
363318	33207
366305	30312
369624	32312
373784	32312
391289	30314
392039	JF6049/10
392996	JD6549/10
397314	32309
871629	32008X
1109767	33108
1121538	575/572X
1301682	32016X
1301683	H913849/10
1301694	33116
1305878	32212
1309568	JHM522649/10
1309570	33018
1357711	30312
1362149	32309
1382900	JXC25723CA/DA
1415140	32021X
1431057	JM822049/10
1439070	NP078914-90UA1
1524625	HM218248/10

SCHMITZ CARGOBULL

10277	HM218248/10
10278	33213
12547	33116
14440	33118
15052	33213
17062	33116
17174	33217

SEDDON ATKINSON

5694	683/672
6736	HM515745/16
15884	495A/493
16595	39581/39520
17397	HM212044/11
22368	H212749/10
22369	HM218248/10
22370	HM220149/10
25840	580/572X

SEDDON ATKINSON...

32885	497/492A
41632	LM67048/10
52828	HM220149/10
63265	594A/592A
63265N	594A/592A
202007	615/612
202115	6379/6320
204702	33287/33462
204707	567X/563
206974	594/592A
209240	56426/56650
209970	594A/592A
210506	47686/47620
913768	566/563
A10830	623/612

TRAILOR

6502196Z	33213
M003168	EK50050
T6014000T000	JM718149A/10
T6015000T000	JM515649/10

VOLVO

11044	30209
11062	32310
11063	32307
11064	32309
11066	32215
11067	32216
11073	32306
11074	32308
11075	32212
11076	32213
11095	32311
11097	30211
11099	32210
11137	32209
11148	3984/3920
18412	30215
18424-18414	3984/3920
18500-18501	387A/382
18599-18414	3982/3920
19273-19272	395S/394A
19468	32218
181001-181002	42687/42620
181077-19276	495A/493
181086	32219
181087	32216
181124-181125	575/572
181127-181128	598/592A
181133-183356	25590/25520
181154/181155	5583/5535
181278-181279	683/672
181280/181281	663/653
181298-181128	594/592A
181299-181125	580/572
181337-181346	6386/6320
181338-181402	537/532X
181338E-181402	537/532X
181348-181125	582/572
181433-181323	HM212044/11
181433-181411	HM212044/11
181434-181008	3782/3720
181546-181352	621-612
181546-181356	621-612
181585-181584	LM11949/10
181588-181587	LM67048/10
181596-181279	687/672
181664-181340	749A/742
181668	32308
181669	32308
183245	39590/39520
183326	HM220149Z/10
183338	32311

VOLVO...

183348	HM215249/10
183424	JM714249/10
183583	32206M
183648	33207
183667	33015
183684	32207
183704	594/592A
183763	32208
183763	32208M
183764	32209
183765	32210
183766	33013
183767	33015
183768	33018
183769	32211
183777	33012
183778	33014
184068	32015X
184088	39580/39520
184593	32209
184623	32018X
184625	32020X
184637	687/672
184672	33213
184678	33115
184679	33208
184794	663/653
184795	683/672
190100-181024	567/563
191298-181128	594/592A
815816	JF7049A/10
815820	39580/39520
1194652	32309
1584340	JF7049A/10
1652099	32212
1652119	30217
1652127	33208
1652563	33212
1654320	JF6049/10
1654326	33214
1656100	30314
1656129	JXC25663CA/663DA
1698580	HM218248/10
1699173	32018X
1699339	33217
1699340	32312
6770270	EK50044
7011137	32209
20428192	39580/39520

C



NOTES

C

Lined area for notes, consisting of multiple horizontal orange lines.



TECHTIPS HEAVY DUTY

TECHNICAL INFORMATION FOR THE INSTALLER

⚠ WARNING Failure to follow these warnings could create a risk of serious injury.

Proper maintenance and handling procedures are critical. Always follow installation instructions and maintain proper lubrication.
Do not attempt to disassemble and reassemble unitized wheel-end hubs and bearing assemblies. Improper reassembly could lead to failure.

⚠ CAUTION Failure to follow these cautions could create a risk of injury.

If a hammer and bar are used for installation or removal of a part, use a mild steel bar (e.g., 1010 or 1020 grade). Mild steel bars are less likely to cause release of high speed fragments from the hammer or bar or the part being removed.

Please note: Tech Tips is not intended to substitute for the specific recommendations of your vehicle manufacturer. Depending on the application, type of hub assembly and location, processes may vary. Please review the vehicle manufacturer's recommendations before removing or installing components.

01 CLEAN WHEEL END COMPONENTS



Remove all residual lubricant and thoroughly clean. Protect against corrosion if bearings are not to be replaced straight away. Fully inspect bearings and, if damage is observed refer to the Timken "Bearing Damage Analysis" wall chart for identification of damage and take appropriate action to correct - Replace all doubtful bearings.

02 BEARING CUP REMOVAL



Using a mild steel bar as a driver, remove both bearing cups, alternate strike to ensure cup does not cock and damage hub. Do not use brass, copper or aluminum as drivers as these could result in damage to the bearings.

- Use scallops in shoulder where present.
- Ensure driver does not contact cup seat/hub bore.

03 SPINDLE CLEANING AND INSPECTION



Remove all residual lubricant and inspect spindle, shoulder, threads and keyway for damage and wear.

- Remove all high spots and burrs with a file, polish with emery cloth.
- Check bearing seats for excessive wear.
- Repair or replace spindles if damaged or worn excessively against the manufacturer's service manual.

04 CUP SEAT CLEANING AND INSPECTION



Remove all residual lubricant and inspect cup seats and shoulders for damage or wear - Remove all high spots and burrs with a file or emery cloth.

- Wear in hubs will reduce interference fit of cups.
- Repair or replace as required in line with the manufacturer's service manual.

Maximising Truck Wheel Bearing Performance

05 CUP INSTALLATION



Using appropriate specified driver tool or mild steel bar ensure the cups progress squarely into their respective seats.

- Listen for the change in strike pitch that indicates that cup is seated correctly.
- Correct seating against shoulder can be checked with 0.051mm (0.002") feeler gauge.

06-A GREASE LUBRICATION (CONES)



Completely fill bearing cones in area under cage, between all rollers by forcing through from roller large end until grease protrudes from small end.

- Coat outside of cage and rollers with grease.

06-A GREASE LUBRICATION (HUB)



Grease hub cavity to manufacturer's recommendations (normally level with and not exceeding cup race level).

- Smear grease or fretting corrosion inhibitor on spindle to prevent fretting corrosion.

06-B OIL LUBRICATION



Coat bearing cones with clean oil.

- Place outboard cone back in packaging to prevent contamination.

07 HUB SEAL INSTALLATION



Ensure you select the correct seal for the lubricant being used.

- Place inboard cone squarely into its mating cup in the hub.
- Install hub seal following seal manufacturer's procedure using proper installation tool.
- Listen for change in strike pitch that indicates seal is seated correctly.
- Check seal is squarely in position and undamaged.

08 HUB ASSEMBLY INSTALLATION ON SPINDLE



Use appropriate wheel dolly to align and present hub assembly to spindle squarely without cocking.

09 ADJUSTMENT – DOUBLE NUT SYSTEM



Inspect adjusting nut threads and overall condition and install hand tight.

- While rotating wheel, use an appropriate torque wrench and socket(s), follow the torque procedure outlined in Table 1 "Wheel Bearing Adjustment Procedure".
- Don't forget to back off the adjusting nut the appropriate amount to suit the specific application prior to installing lock washer(s) and jam nut. Note - For single nut self-locking systems consult manufacturer's instructions.

10 ENDPLAY MEASUREMENT



The adjustment procedure allows the wheel to rotate freely with 0.025 to 0.125mm (0.001" to 0.005") end play – Attach dial indicator via magnetic base to hub or drum – Adjust indicator so plunger contacts spindle face and its line of action is parallel to centerline of spindle (Aluminum hubs - attach the magnetic base to spindle end with the plunger contacting the hub or drum) – Grasp wheel assembly at 3 and 9 o'clock and push while oscillating to seat the bearings. Zero the indicator. Repeat the process only this time pull the wheel while oscillating. – The indicator movement is the end play in the hub. – Make fine adjustments until endplay is within the range specified above – Apply any final retention mechanisms.

Maximising Truck Wheel Bearing Performance

11 INSTALL HUB CAP



Install hub cap using new gasket being careful not to over-tighten bolts as per the manufacturer's instructions.

Oil lubrication :

- Add clean oil to hub through provision in hub cap to manufacturer's recommended level.
- Rotate wheel assembly and recheck.
- Top up if required.

TABLE 1 : WHEEL BEARING ADJUSTMENT PROCEDURE

STEP 1	STEP 2	STEP 3	STEP 4	STEP 5			STEP 6		STEP 7	
Lubricate	Initial Adjusting Nut Torque	Initial Back Off	Final Adjusting Nut Torque	Back Off			Jam Nut Torque		Acceptable End Play	
Lubricate the wheel bearing with clean axle lubricant of the same type used in the axle sump or hub assembly. NOTE: Never use an impact wrench when tightening or loosening lug nuts or bolts during the procedure.	271 Nm (200 lb-ft) while rotating wheels.	One full turn.	68 Nm (50 lb-ft) while rotating wheels.	Axle Type	Threads per inch	Final Back-off	Nut Size	Torque Specifications	0.025 - 0.125mm (0.001" - 0.005"). As measured per procedure with dial indicator.	
				Steer (Front) Non-drive	12	1/6 turn*	Install Cotter Pin to lock axle nut in position.			
					18	1/4 turn*				
					Drive	14	1/2 turn	Less than 66.7mm (2 5/8")		271-407Nm (200-300 lbft)
						18				407-542Nm (300-400 lbft)
				Trailer	12	1/4 turn	66.7mm (2 5/8") and over	Tang type washer**		271-373Nm (200-275 lbft)
					16			407-542Nm (300-400 lbft)		

* If dowel pin and washer (or washer tang and nut flat) are not aligned, remove the washer, turn it over, and re-install. If required, loosen the inner (adjusting) nut just enough for alignment.
 ** Bendable type washer lock only. Secure nuts by bending one wheel nut washer tang over the inner and outer nut. Bend the tangs over the closest flat perpendicular to the tang.

The following service procedures apply to steer, drive and trailer axle assemblies using conventional double nut or single nut systems. If you have a system that differs from what is indicated in this procedure, consult the vehicle manufacturer's procedure.

TECHTIPS HEAVY DUTY

TECHNICAL INFORMATION FOR THE INSTALLER

FOREIGN MATERIAL

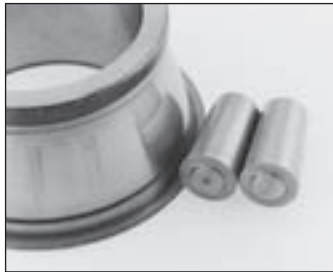

Abrasive wear —
Fine abrasive particle contamination.



Grooving —
Large particle contamination imbedding into soft cage material.

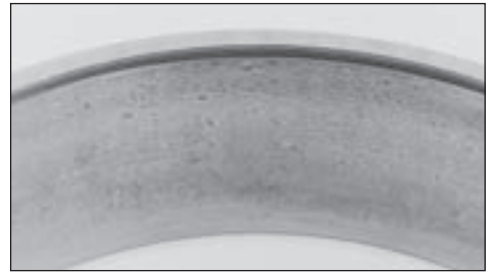

Bruising —
Debris from other fatigued parts, inadequate sealing or poor maintenance.

CORROSION/ETCHING

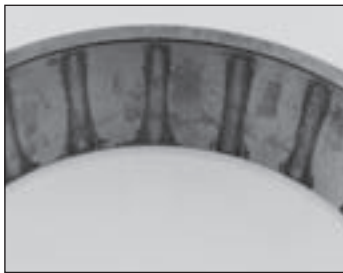

Staining —
Surface stain with no significant corrosion from moisture exposure.



Etching —
Rusting with pitting and corrosion from moisture/water exposure.



Line spalling —
Roller-spaced spalling from bearings operating after etching damage.

INADEQUATE LUBRICATION*

** Excessive preload can cause damage similar to inadequate lubrication damage.*



Roller end scoring —
Metal-to-metal contact from breakdown of lubricant film.



Cone large rib face scoring —
“Welding” and heat damage from metal-to-metal contact.



Total bearing lock-up —
Rollers skew, slide sideways and lock-up bearing.



Cone large rib face deformation —
Metal flow from excessive heat generation.

Bearing Damage Analysis

FATIGUE SPALLING

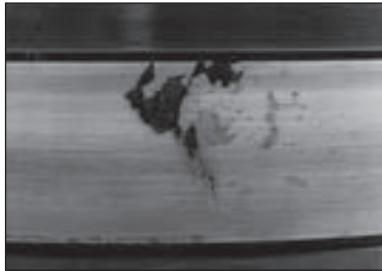

Point surface origin — Spalling from debris or raised metal exceeding the lubricant film thickness.

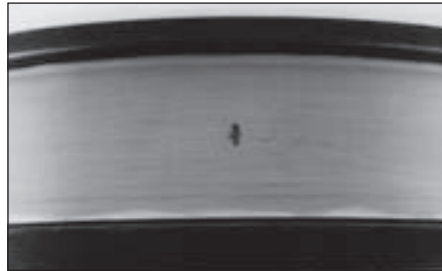

Inclusion origin — Spalling from oxides or other hard inclusions in bearing steel.



Geometric stress concentration — Spalling from misalignment, deflections or heavy loading.

EXCESSIVE PRELOAD OR OVERLOAD



Rapid and deep spalling caused by unusually high stresses. Full race width fatigue spalling is caused by heavy loads creating a thin lubricant film and possible elevated temperatures.

MISALIGNMENT



Irregular roller path from deflection, inaccurate machining or wear of bearing seats.

HIGH SPOTS IN CUP SEATS



Localized spalling on the cup race from stress riser created by split housing pinch point.

TECHTIPS HEAVY DUTY

TECHNICAL INFORMATION FOR THE INSTALLER

HANDLING DAMAGE



Roller nicking/denting — Rough handling or installation damage.

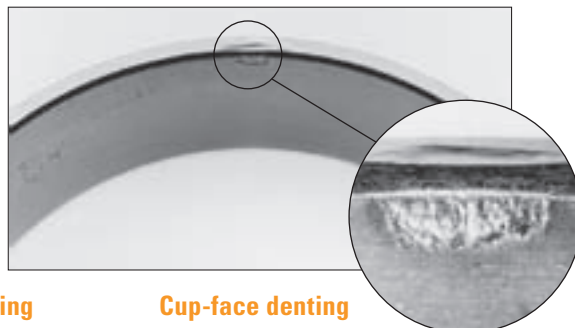

Cup-face denting — Indentations from hardened driver.



Roller spaced nicking — Raised metal on races from contact with roller edges.

CAGE DAMAGE



Rollers binding and skewing — Cage ring compressed during installation or interference during service.



Cage deformation — Improperly installed or dropped bearing.

IMPROPER FIT



Cone bore damage — Fractured cone due to out-of-round or oversized shaft.



Cup spinning — Loose cup fit in a rotating wheel hub.

Bearing Damage Analysis

FALSE BRINELLING

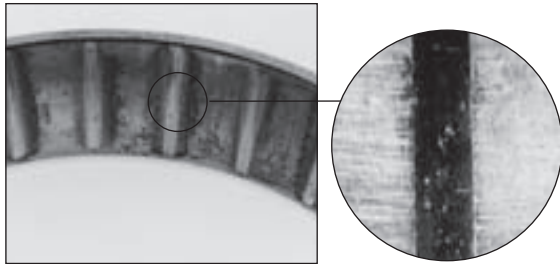

Wear caused by vibration or relative axial movement between rollers and races.

TRUE BRINELLING

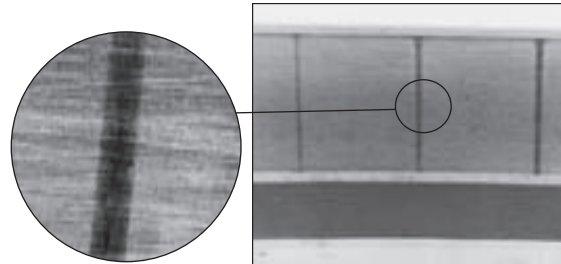

Damage from shock or impact.

ELECTRIC CURRENT

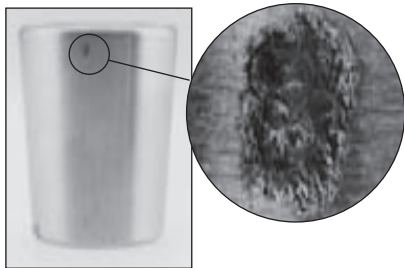

Electric arc pitting — Small burns created by arcs from improper electric grounding while the bearing is stationary.

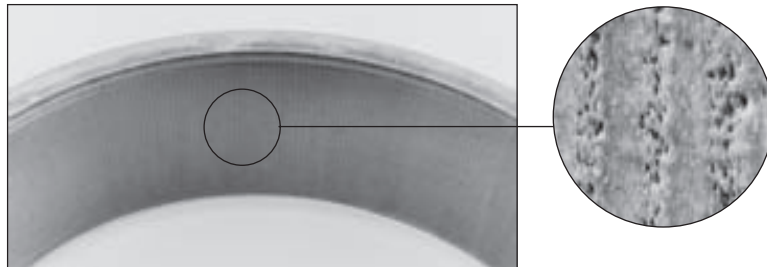

Fluting — Series of small axial burns caused by electric current passing through the bearing while it is rotating.

PEELING

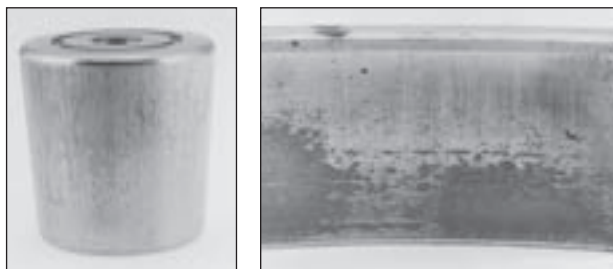

Micro-spalling due to thin lubricant film from high loads/low RPM or elevated temperatures.

EXCESSIVE END PLAY

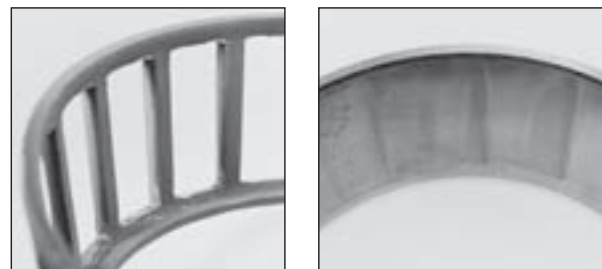

Cage pocket wear — Heavy contact between the rollers and cage pocket surfaces caused by bearing operating too loose.

Scalloping — Uneven localized wear resulting from excessive end play.



NOTES



Lined area for notes with horizontal orange lines.



BEARING INSTALLATION TOOLS

Induction Heater VHIN 10

With more than 100 years of experience in bearing technology, Timken understands the importance of proper maintenance procedures in maximizing product and equipment life. High-quality Timken maintenance products help to decrease down-time and lower operating costs.

Our line of maintenance tools are an example of how we extend beyond bearings with friction management solutions to keep your business running smoothly. These value-added products are grounded in our knowledge of motion, lubrication, friction and metallurgy. Induction Heaters are designed to help you extend bearing life in your applications through proper installation, removal and service.

For more than 100 years, Timken has provided quality products to the industrial marketplace. Induction Heaters are made to the same exacting quality standards you've come to expect from Timken® bearings. Our field support team is available to help you use the tools appropriately, as well as identify other Timken solutions that may boost your productivity and save you money.

Timken offers a large assortment of high-quality induction heaters designed for demanding applications. They can heat and radially expand a wide variety of gears, rings, couplings, bearings and other components.

All heaters are produced in accordance with International (IEC) and European (CE) health and safety requirements. They feature a microprocessor-controlled power supply, automated time and temperature control and automatic demagnetization.

Portable design,
easy to use,
ideal for on-site jobs.
Includes four yokes

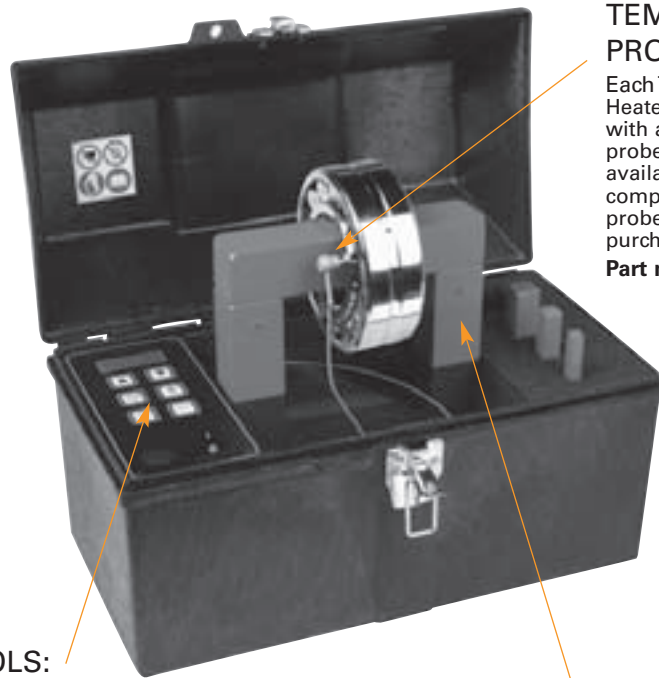

TEMPERATURE PROBE:

Each Timken Induction Heater model is supplied with a magnetic temperature probe. A clamp is also available for nonferrous components. Replacement probes are also available for purchase.

Part number: VHIA 100001

DIGITAL CONTROLS:

All digital controls operate by time or temperature in °C or °F

HORIZONTAL SUPPORT:

Support for heating in horizontal position.

VHIN 10 Model

Min. Bore 15 mm (0.6")
Max. O.D. 210 mm (8.3")
Max. Width 120 mm (4.8")
Max. Weight 15 kg (33 lbs.)

VHIN 10	230V, Yoke set: 10/14/20/40
VHIN 101	120V, Yoke set: 10/14/20/40



Type	VHIN 10
ELECTRICITY	
Power Rating	3.6 k VA
Voltage/Current	120V/20A 230V/16A
Different Voltage Option	—
Frequency	50/60 Hz
Swing Arm	No
Plug	Yes
WORK PIECE	
Max. Weight	
- Bearings	15 kg (33.1 lbs.)
- Other Parts	10 kg (22.1 lbs.)
Min. Bore Diameter	15 mm (0.6")
Max O.D.	210 mm (8.3")
Vertical/Horizontal	
Max. Work Piece Width	120 mm (4.7")
POLE DIMENSIONS	
Area between the poles	120 x 130 mm (4.7" x 5.1")
Width x Height	
Pole Section	40 mm (1.6")
Pole Height	130 mm (5.1")
CONTROLS	
Temperature Control	
Max. Temp	150° C (302° F)
Time Control	
Max. Time	0 – 30 Min.
Auto Power Reduction	—
OPTIONS	
Yokes, Standard	10,14, 20, 40 mm (0.4", 0.6", 0.8", 1.6")
Support for Horizontal Heating	(in case) —
Mobile	—
Temperature Control	—
DIMENSIONS	
Dimensions	435 x 225 x 275 mm (17.1" x 8.9" x 10.8")
Package Size	500 x 250 x 350 mm (19.7" x 9.8" x 13.8")
Mass Heater Body (excludes yokes)	21 kg (46.3 lbs.) (includes yokes)
MISCELLANEOUS	
Sound Signal	yes
Temperature Hold	yes
Demagnetizing <2 A/cm	yes
Thermal Safety Guard	yes
Magnetic Temperature Probe	yes
DIGITAL DISPLAY	
Temperature	yes
Time	yes
Error Report	yes

Why choose an induction heater?

Induction heating is a superior, fast and controlled heating method. It is a safe and environmentally friendly alternative for traditional heating methods such as ovens, oil baths or blow torches. These methods cause smoke, fumes or oil waste and are hazardous for personal health and safety.

Timken induction heaters use the principle of induction, similar to a transformer. The heater and yokes remain cool; only the work piece is heated. During the induction heating cycle, a certain degree of magnetism occurs. All Timken heaters demagnetize automatically after each heating cycle.

Versatility, safety and quality





Timken induction heaters can be used for heating gear wheels, bushings, couplings and other components. Proper mounting lengthens the life span of your equipment, and controlled induction heating helps prevent unnecessary damage.

Digital electronics provide optimal control during the heating process and automatically select the most efficient power supply to ensure balanced and fast heating.

Timken induction heaters are dependable. The robust and easy-to-use designs offer you reliable heaters that are suitable for continuous operation in industrial environments.



Plug & Heat Models - please add the following suffix to the appropriate part number to identify your plug:

Plug & Heat	Suffix	Plug type
	-	European plug 
	GB	UK 3-pin plug 
	US	US 2-flat pin plug 
	EN	3-round pin plug 

BEARING INSTALLATION TOOLS

Impact Fitting Tool

THIS METRIC MOUNTING SET CONSISTS OF:



- 33 Collets
- 3 Sleeves
- 1 Impact hammer weighing 0.7 kg (1.5 lbs.) absorbs shock and vibration
- Case dimensions:
430 x 320 x 100 mm
(16.9" x 12.6" x 4.0")



Part Number: VIFT 3300

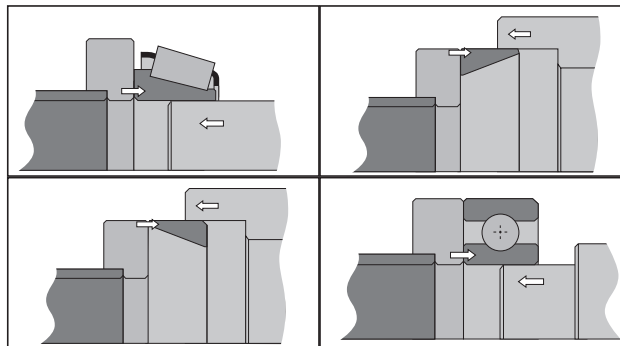

◀ Proper mounting allows the load to be transmitted to the ring experiencing the interference fit. This way, mounting forces are not transmitted via the rolling elements, avoiding damage to the raceways.

Proper mounting is essential to ensure long bearing life. Designed to permit the safe, precise and quick mounting of bearings, bushings, sealing rings, cam wheels and pulleys, the Timken Impact Fitting Tool Set features impact-resistant plastic collets, which help to avoid metal-to-metal contact and the resulting shaft damage.

During the mounting of bearings, such as ball and spherical roller bearings, where the faces lie in the same plane, the collets enable the load to be transmitted to the ring experiencing the interference fit. In this way, mounting forces are not transmitted via the rolling elements and hence damage to the raceways is avoided.

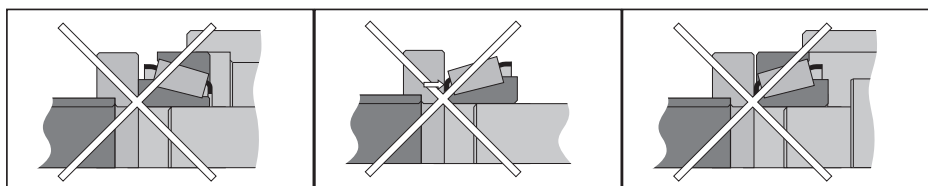

Sleeve	Ring	All ISO bearings codes ending with:	60,62, 63,64	12,22, 13,23	70, 72B, 73B	32, 33	222,213, 223	NU,NJ,N 2 3 4	302, 322, 303, 330	320, 313, 323, 332	
A1	10-26	000	6000	129	7000						
	10-30	200	6200 2200	1200		3200					
	10-35	300	6300	1300	7300						
	12-28	001	6001								
	12-32	201	6201 2201	1201		3201					
	12-37	301	6301 2301	1301	7301						
	15-32	002	6002								
	15-35	202	6202 2202	1202	7202B	3202					
	15-42	302	6302 2302	1302		3302			30302		
	17-35	003	6003 16003								
	17-40	203	6203 2203	1203	7203B	3203			30203		
	17-47	303	6303 2303	1303	7303B	3303			30303	32303	
	B2	20-42	004	6004		7004					32004
		20-47	204	6204 2204	1204	7204B	3204		204	30204	
		20-52	304	6304 6403	1304 2304	7304B	3304	21304	304	30304	32304
		25-47	005	6005		7005					32005
		25-52	205	6205 2205	1205	7205B	3205	22205	205 32205	30205	33205
25-62		305	6305 6404	1305 2305	7305B	3305	21305	305	30305	31305 32305	
30-55		006	6006							32006	
30-62		206	6206 2206	1206	7206B	3206	22206	206 32206	30206	33206	
30-72		306	6306 6405	1306 2206	7306B	3306	21306	306 405	30306	31306 32306	
C3		35-62	007	6007		7007					32007
		35-72	207	6207 2207	1207	7207B	3207	22207	207 32207	30207	33207
		35-80	307	6307 6406	1307 2307	7307B	3307	21307	307 406	30307	31307 32307
		40-68	008	6006							32008
	40-80	208	6208 32208	1208	7208B	3208	22208	208	30208	33208	
	40-90	308	6308 6407	1308 2308	7308B	3308	21308 22308	308 407	30308	31308 32308	
	45-75	009	6009						32009		
	45-85	209	6209 2209	1209	7209B	3209	22209	209 32209	30209	33209	
	45-100	309	6309 6408	1309 2309	7309B	3309	21309 22309	309 408	30309	31309 32309	
	50-80	010	6010						33010	32010	
	50-90	210	6210 2210	1210	7210B	3210	22210	210 32210	30210	33210	
	50-110	310	6310 6409	1310 2310	7310B	3310	21310 22310	310 409	JM205149/JM205110 30310	31310 32310	

Impact rings 50-90, 45-100, 50-110 also fit the following bearing where only the outer ring is to be fitted (e.g. shaft is not installed)

C3	50-90		6011 6012							
	45-100		6013 6211	1211 2211	7211B 7212B	3211	22211	211		
	50-110		6014 6015 6212 6213	1212 1213 2213 2213	7213B	3212 3213 3211	22212 22213 21311	212 213 311		
			6311 6410	1311 2311				22311 410		

For tapered bearings, impact rings fit outer ring and also inner ring if driving is from larger diameter side. The numbers on each impact ring (e.g. 25-62) are clearly marked on the ring. The first figure refers to shaft diameter, the second to bearing outer diameter

REMOVAL TOOLS

Mechanical Pullers



After the required type of puller has been identified, it is easy to choose the most suitable model from the series listed in the catalog.

Please note: Understanding the work space and possibility of gripping will ensure proper fit of grip.

Compare size and measurement of the part to be removed to the values indicated in the tables to choose the suitable puller. The choice of mechanical puller depends also on required pulling force.

The most important factor is safety. If you're not sure which size puller to use, always choose the larger or stronger one. Three-arm pullers better distribute the pulling force than two-arm devices. Therefore, if there is enough space, three-arm pullers should be the first choice.

NEW

Mechanical 3-Jaw Pullers

For economical-minded maintenance professionals, Timken offers a simple to use mechanical line of pullers. Several of our mechanical pullers have a self-centering feature – making life easier for you.



NOTES



Lined area for notes, consisting of multiple horizontal orange lines.



Mechanical Pullers



Model	Max. Withdrawal Force t	Arm Length	Width of Grip	Stroke Width	A	B	C	D	E	F	G	Mass
VMPS2	2	80 mm (3.1 in.)	120 mm (4.7 in.)	-	8.3 mm (0.3 in.)	6 mm (0.2 in.)	15 mm (0.6 in.)	-	-	-	16 mm (0.625 in.)	1.6 kg (3.5 lbs.)
VMPS3	3	120 mm (4.7 in.)	180 mm (7.1 in.)	-	6 mm (0.2 in.)	7 mm (0.3 in.)	15 mm (0.6 in.)	-	-	-	16 mm (0.625 in.)	2.3 kg (5.1 lbs.)
VMPS5	5 t	160 mm (6.3 in.)	270 mm (10.6 in.)	-	11 mm (0.4 in.)	10 mm (0.4 in.)	25 mm (1 in.)	-	-	-	19 mm (0.75 in.)	4.3 kg (9.5 lbs.)
VMPS8	8	210 mm (8.3 in.)	300 mm (11.8 in.)	-	13 mm (0.5 in.)	14 mm (0.6 in.)	27 mm (1.1 in.)	-	-	-	19 mm (0.75 in.)	6.1 kg (13.4 lbs.)

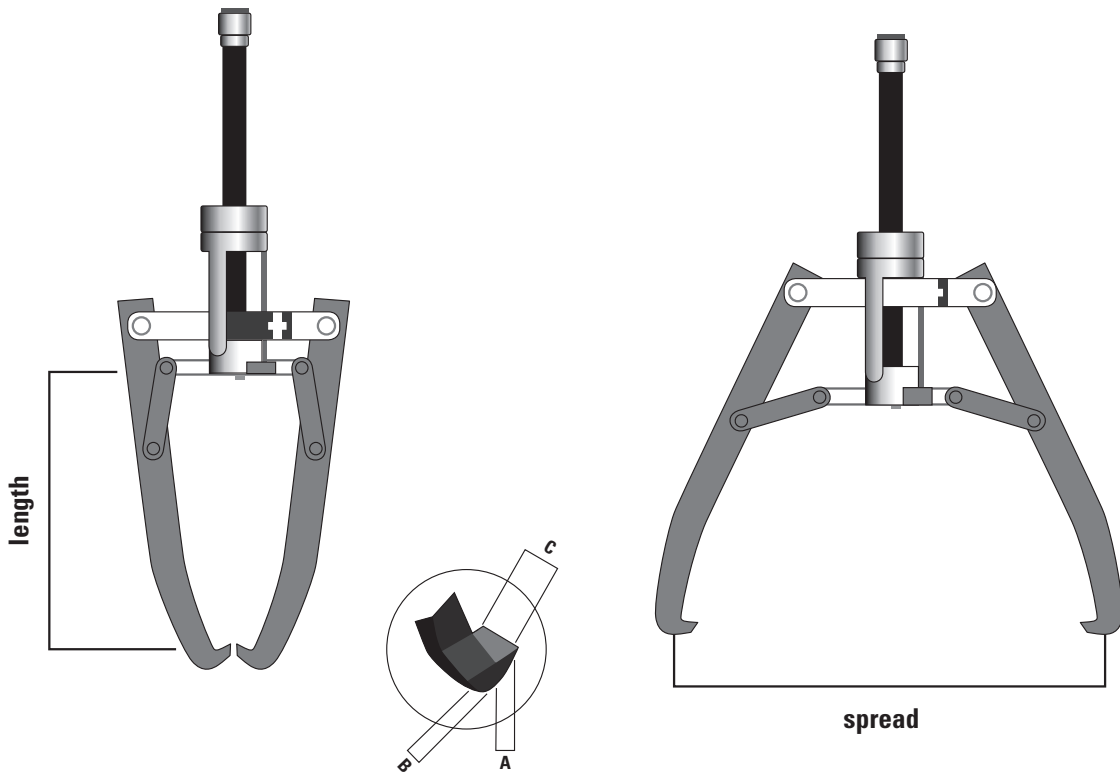

⚠ UWAGA! Nie zastosowanie się do poniższych ostrzeżeń może skutkować powstaniem ryzyka poważnych uszkodzeń ciała.

Bardzo ważna jest odpowiednia konserwacja i obsługa łożysk. Nieprzestrzeganie przygotowanej przez producenta instrukcji montażu i brak właściwego smarowania może doprowadzić do awarii urządzeń.

Nigdy nie należy wprawiać łożyska w ruch przy użyciu sprężonego powietrza. Może to doprowadzić do wypadnięcia waleczków z kosza z dużą siłą.

Note

Firma Timken z ogromną starannością przygotowała i wydała ten katalog, lecz w żadnym wypadku nie ponosi odpowiedzialności za jakiegokolwiek błąd lub pominięcia. Timken zastrzega sobie prawo do wprowadzania zmian w treści tego katalogu bez uprzedzenia. Treść tego katalogu jest własnością The Timken Company i nie wolno jej powielać, w żadnej formie, w całości lub częściowo, bez pisemnej zgody The Timken Company. Wszelkie dane o przeznaczeniu łożysk obejmują tylko okres do daty podanej na okładce katalogu.

⚠ POZOR! Přehlédnutí následujícího varování může zapříčinit nebezpečí vážného zranění.

Řádné postupy údržby a manipulace jsou nezbytnými předpoklady. Nedodržení instrukcí výrobce vozidla na instalaci a zanedbání řádného mazání může způsobit selhání zařízení s následkem rizika vážného zranění.

Nikdy neroztácejte ložisko stlačeným vzduchem. Valivé prvky mohou být prudce vymršťeny a mohou způsobit vážné zranění.

POZNÁMKA

Společnost Timken mimořádně dbá na vývoj a výrobu tohoto katalogu, ale nemůže být za žádných okolností odpovědná za jakékoli chyby či opomenutí. Timken si vyhrazuje právo upravit obsah tohoto katalogu bez předchozího oznámení. Obsah tohoto katalogu je majetkem The Timken Company a nesmí být reprodukován v žádné formě, celý či částečně, bez písemného povolení The Timken Company. Údaje o použitelnosti dílů jsou uvedeny k datu vydání katalogu, které je uvedeno na přebalu.

⚠ AVERTISMENT! Nerespectarea următoarelor avertismente poate provoca accidente grave.

Mentenanța potrivită și practicile de manipulare sunt esențiale. Nerespectarea instrucțiunilor de instalare ale producătorului vehiculului și de mentinere a ungerii corespunzătoare pot determina pana echipamentului, existând riscuri de rănire gravă.

Nu curățați niciodată un rulment cu aer comprimat. Rolele pot fi expulzate cu putere, existând riscuri de rănire gravă.

Notă

Timken a acordat o grijă deosebită în cercetarea și crearea acestui catalog, dar nu își asumă responsabilitatea pentru orice eroare sau omisiune. Timken își rezervă dreptul să modifice conținutul acestui catalog fără notificare prealabilă. Conținutul acestui catalog este proprietatea Companiei Timken și nu poate fi reproduș, sub nici o formă, integral sau parțial, fără aprobarea în scris din partea Companiei Timken. Catalogul conține detalii ale aplicațiilor apărute până la data publicării acestuia, dată înscrisă pe copertă.

⚠ FIGYELMEZTETÉS! A következő utasítások be nem tartása akár súlyos testi sérülést is okozhat.

A megfelelő karbantartási és kezelési gyakorlat döntő jelentőségű. A gépjárműgyártó beépítési utasításainak be nem tartása és a megfelelő kenés elmulasztása a berendezés meghibásodását okozhatja, akár súlyos testi sérülés kockázatát okozva ezzel.

Soha ne forgasson csapágyat sűrített levegővel. A görgők elszabadulhatnak, ami következtében fennállhat a sérülés veszélye.

Nota

A Timken rendkívüli gondossággal járt el jelen katalógus vizsgálatában és előállításában, azonban semmilyen körülmények között sem lehet felelős bármely hibáért vagy hiányosságért. A Timken fenntartja a jogot jelen katalógus tartalmának előzetes értesítés nélküli módosítására. Jelen katalógus tartalma a The Timken Company tulajdonát képezi, és a The Timken Company írásos engedélye nélkül semmilyen formában nem reprodukálható, egészében vagy részben sem. Az alkalmazási adatok csak a katalógus gyártási dátumát megelőző évjáratú járművekre érvényesek.

⚠ ВНИМАНИЕ! Несоблюдение следующих предупреждений может привести к серьезным травмам и повреждениям.

Важно соблюдать правильные методы технического обслуживания и обращения с подшипниками. Несоблюдение указаний компании-изготовителя автомобиля по монтажу и надлежащему поддержанию подшипников в смазанном состоянии может привести к отказу оборудования, сопряженному с риском получения тяжелой травмы.

Никогда не вращайте подшипник при помощи сжатого воздуха. Это может привести к вы抛су из него роликов.

ПРИМЕЧАНИЕ

Компания Timken приняла все возможные меры при проведении исследований и подготовке этого каталога, однако ни при каких обстоятельствах не может нести никакой ответственности за любые ошибки или пропуски. Компания Timken оставляет за собой право внесения изменений в этот каталог без предварительного уведомления. Содержание этого каталога является собственностью The Timken Company и не может воспроизводиться в любой форме, полностью или частично, без письменного разрешения The Timken Company. Актуальность всей технической информации соответствует дате, указанной на титульном листе каталога.

Symbol	P	PL	CZ	HU	RO	RU
	Eixo	Oś	náprava	Futómű	Osie	Мост
	Eixo rígido	Oś sztywna	Tuhá osa	Merev tengely	Osie rigidă	Зависимая подвеска
	Eixo semi-rígido	Oś półsztywna			Osie semirigidă	Полузависимая подвеска
	Eixo direccional	Oś kierowana	Hřídel řízení	Kormányzott futómű	Ax de direcție	Управляемый мост
	Manga de eixo	Zwrotnica (osi przedniej)		Tengelycsukló	Fuzetă	Поворотный кулак
	Eixo duplo	Układ dwóch osi posobnych	Tandemová hřídel	Kettős tengely	Osie în tandem	Спаренный мост
	Roda	Koła jezdne pojedyncze	Jedno kolo	Szimpla kerék	Roată simplă	Односкатное колесо
	Rodas gémeas	Koła jezdne bliźniacze	Zdvojená kola	Dupla kerék	Roți pereche	Двухскатное колесо
	Rodas de disco	Koła tarczowe		Keréktárcsa	Roată plină	Дисковое колесо
	Rodas de raio	Koła szprychowe		Kerékküllő	Roată cu spițe	Спичевое колесо
	Cubo de roda	Piasta	Náboj	Kerékagy	Butuc de roată	Ступица
	ABS	ABS	ABS	ABS	ABS	АБС
	Sem ABS	bez ABS-u	Bez ABS	nincs ABS	Fără ABS	без АБС
	Travões de disco	Hamulce tarczowe	kotoučová brzda	Tárcsafék	Frână cu disc	Дисковые тормоза
	Travões de tambor	Hamulce bębnowe	bubnová brzda	Dobfék	Frână cu tambur	Барабанные тормоза
	Mola de lâminas	Resor Piórowy	Listová pružina	Laprugó	Arc cu foi	Рессорная подвеска
	Suspensão pneumática	Zawieszenie pneumatyczne	Vzduchové pérování	Légrugó	Pernă de aer	Пневматическая подвеска
	Trilex	Koła jezdne typu Trilex	Trilex	Trilex kerék	Trilex	Обод «трилекс»
	Sem Trilex	Bez kół jezdnych typu Trilex	Bez trilexu	Trilex nélküli	Fără Trilex	Обычный обод
	Lubrificado a óleo	Smarowany olejem	Mazaný olejem	Olajkenés	Lubrificate cu ulei	Смазывание жидкой смазкой
	Lubrificado a massa	Smarowany smarem stałym	Mazaný tukem	Zsírkénés	Lubrificate cu vaselină	Смазывание густой смазкой
	Com cubo centrado	Z centrowaniem na piaście			Cu centrare pe butuc	С центрированием по ступице
	Sem cubo centrado	Bez centrowania na piaście			Fără centrare pe butuc	Без центрирования по ступице
	Com redução do cubo	Z redukcją na piaście	S redukcí v náboji		Cu reducție pe butuc	Со ступичным редуктором
	Sem redução do cubo	Bez redukcji na piaście	Bez redukcje v náboji		Fără reducție pe butuc	Без понижающего редуктора
	Roda de ligação de montagem dupla	Podwójnie mocowane koło zestawu tocznego			Roată conducătoare dublă	Сдвоенное свободное колесо
	Porca de bloqueio	Śruba zaciskowa		Biztosító anya	Piuliță de blocare	Контрольная гайка
	Roda de ligação de montagem simples	Pojedyńczo mocowane koło zestawu tocznego			Roată conducătoare simplă	Одинарное свободное колесо
	Suspensão de trapézio	Zawieszenie trapezowe		Trapéz felfüggesztés	Suspensie trapezoidală	Трапецидальная балка
	Fila única de rolamentos de roletes cônicos	Jednorzędowe łożysko stożkowe	Jednořadé kuželkové ložisko	Egyszeres kúpögörgős csapágy	Rulment conic pe un singur rând	Конический однорядный подшипник
	Com redução simples	Z pojedynczą redukcją			Cu transmisie simplă	С одноступенчатым понижением
	Com vedante preto	Z czarnym uszczelnieniem	S černým těsněním	Fekete tömítéssel	Cu etanșare neagră	С черным уплотнением
	Com vedante azul	Z nebieskim uszczelnieniem	S modrým těsněním	Kék tömítéssel	Cu etanșare albastră	С синим уплотнением
	Com molas suaves	Z miękkimi resorami	S měkkou pružinou	Lágyrugóval	Cu arcuri moi	С мягкими пружинами
	Com molas rígidas	Ze sztywnymi resorami	S tvrdou pružinou	Merev rugóval	Cu arcuri rigide	С жесткими пружинами
	Ch. SCANIA Sodertälje 1242205 - - Ch. SCANIA Zwolle 4397541 - - Ch. SCANIA Angers 9034654 - - Ch. SCANIA Katrineholm 1833391					

Symbol	GB	E	F	D	I
	Axle	Eje	Essieu	Achse	Asse
	Rigid Axle	Eje Rígido	Essieu rigide	Starrachse	Assale rígido
	Semi Rigid Axle	Eje semi-rígido	Essieu semi-rigide	Schräglenkerachse	Assale semi rigido
	Steering Axle	Eje de dirección	Essieu de direction	Lenkachse	Assale sterzante
	Stub Axle	Mangueta	Essieu fusée	Achsschenkel	Assale fuso
	Tandem Axle	Eje tandem	Essieu double	Tandemachse	Assale tandem
	Single Wheel	Rueda simple	Roue simple	Einzelrad	Ruota singola
	Twin Wheels	Ruedas gemelas	Roue jumelée	Zwillingsrad	Ruote gemellate
	Disc Wheels	Ruedas de disco	Moyeu disque	Radscheiben	Ruote a disco
	Spoke Wheels	Ruedas de disco perforado	Moyeu étoile	Zackenscheiben	Ruote a razze
	Hub	Buje	Moyeu	Radnabe	Mozzo
	With ABS	Con ABS	ABS	ABS	ABS
	Without ABS	Sin ABS	Sans ABS	Kein ABS	senza ABS
	Disc Brake	Frenos de disco	Freins à disques	Scheibenbremsen	Freni a disco
	Drum Brake	Frenos de tambor	Freins à tambour	Trommelbremsen	Freni a tamburo
	Leaf Spring	Ballesta	Ressort à lames	Blattfeder	Balestra a lame
	Air Suspension	Suspensión neumática	Suspension pneumatique	Luftfederung	Sospensioni ad aria
	Trilex	Trilex	Trilex	Trilex	Trilex
	Without Trilex	Sin Trilex	Sans Trilex	Ausser Trilex	Eccetto Trilex
	Oil Lubricated	Lubricado con aceite	Lubrification à l'huile	Ölgeschmiert	Lubrificato ad olio
	Grease Lubricated	Lubricado con grasa	Lubrification à la graisse	Fettgeschmiert	Lubrificato a grasso
	With Hub Centration	Con cubo centrado	Avec centrage de moyeu	Mit Nabenzentrierung	Con mozzo centrale
	Without Hub Centration	Sin centrado del cubo	Sans centrage de moyeu	Ohne Nabenzentrierung	Senza mozzo centrale
	With Hub Reduction	Con reducción en cubo	Avec réducteur dans le moyeu	Mit Nabenverkleinerung	Con riduzione mozzo
	Without Hub Reduction	Sin reducción en cubo	Sans réducteur dans le moyeu	Ohne Nabenverkleinerung	Senza riduzione mozzo
	Double Mounted Trailing Wheel	Rueda gemela portante	Essieu suiveur roues jumelées	Nicht angetriebenes Zwillingsrad	Ruote folle doppia
	Locking Nut	Tuerca de cierre	Ecrou	Sechskantmutter	Dado di bloccaggio
	Single Mounted Trailing Wheel	Rueda sencilla portante	Essieu suiveur roues simples	Nicht angetriebenes Einzelrad	Ruote folle singola
	Trapeze Suspension	Suspensión trapeze	Suspension trapeze	Trapezfederung	Sospensioni a trapezio
	Single Row Tapered Roller Bearing	Rodamiento de rodillos cónicos	Roulement à rouleaux coniques	Einreihiges Kegelrollenlager	Cuscinetto a rulli conici a singola file
	With Single Reduction	Con reducción simple	Sans réducteur dans le moyeu	Mit einfacher Unteretzung	Con sigola riduzione
	With Black Seal	Con retén de aceite negro	Avec joint noir	Mit schwarzer Dichtung	Con guarnizione nera
	With Blue Seal	Con retén de aceite azul	Avec joint bleu	Mit blauer Dichtung	Con guarnizione blu
	With Soft Springs	Ballestas blandas	Suspension souple	Mit weicher Feder	Con molle morbide
	With Stiff Springs	Ballestas duras	Suspension renforcée	Mit starrer Feder	Con molle rigide
	Ch. SCANIA Sodertajle 1242205 - - Ch. SCANIA Zwolle 4397541 - - Ch. SCANIA Angers 9034654 - - Ch. SCANIA Katrineholm 1833391				



TIMKEN

Where You Turn

Bearings • Specialty Steel •
Precision Components • Lubrication •
Seals • Remanufacture and Repair •
Engineering Services

www.timken.com

Timken® is a registered trademark of
The Timken Company

© 2009 The Timken Company
Printed in Europe.
Order No. E0374